CoaXPress

Color / Monochrome CMOS Camera

STC-CMB120ACXP

(12M / Monochrome / M42 mount / Din connector on Rear)

STC-CMB120ACXP-F

(12M / Monochrome / F mount / Din connector on Rear)

STC-CMC120ACXP

(12M / Color / M42 mount / Din connector on Rear)

STC-CMC120ACXP-F

(12M / Color / F mount / Din connector on Rear)

STC-CMB120ACXP-T

(12M / Monochrome / M42 mount / Din connector on Top)

STC-CMB120ACXP-T-F

(12M / Monochrome / F mount / Din connector on Top)

STC-CMC120ACXP-T

(12M / Color / M42 mount / Din connector on Top)

STC-CMC120ACXP-T-F

(12M / Color / F mount / Din connector on Top)

Product Specifications and User's Guide



Table of Contents

1	Product Precautions	5
2	Product conformity / compliance	5
3	Warranty	5
4	Overview	6
4.1	Features	6
4.2	Product Number Naming Method.....	6
5	Specifications	7
5.1	Electronic Specifications.....	7
5.2	Spectral Sensitivity Characteristics	8
5.3	Mechanical Specifications	9
5.3.1	STC-CMB120ACXP / STC-CMC120ACXP / STC-CMB120ACXP-T / STC-CMC120ACXP-T.....	9
5.3.2	STC-CMB120ACXP-F / STC-CMC120ACXP-F / STC-CMB120ACXP-T-F / STC-CMC120ACXP-T-F.....	9
5.4	Environmental specifications.....	10
5.5	Connector Specifications.....	11
5.5.1	DIN Connector.....	11
5.5.2	Power/IO Connector.....	12
5.5.3	GPIO Circuit (Input).....	13
5.5.4	GPIO Circuit (Output).....	14
5.6	Conector Indicator Lamps (LED) Specifications	16
6	Dimensions	17
6.1	STC-CMB120ACXP / STC-CMC120ACXP / STC-CMB120ACXP-F / STC-CMC120ACXP-F	17
6.2	STC-CMB120ACXP-T / STC-CMC120ACXP-T / STC-CMB120ACXP-T-F / STC-CMC120ACXP-T-F	18
7	Camera operation	19
7.1	Frame rate calculation fomula	19
7.2	Saving and Loading a data.....	20
7.2.1	Save Setting	20
7.2.2	Load Setting	21
7.2.3	Camera startup.....	21
7.2.4	Camera initialization.....	21
7.3	GenlCam command	22
7.3.1	DeviceControl.....	22
7.3.2	ImageFormatControl	23
7.3.3	AcquisitionControl	23
7.3.4	TransportLayerControl	24
7.3.5	DigitalIOControl	24
7.3.6	AnalogControl.....	24
7.3.7	LUTControl.....	25
7.3.8	UserSetControl.....	25
8	Revision History	26

Precautions for safety

Please read carefully this "Precautions for safety" before use the camera. Then the camera uses correctly with agreeing with below notes.

In this "Precautions for safety", notes divides into "Warning" and "Caution" to use the camera safety and prevent to harm and damage.

 Warning	This shows, assumption for possibility of serious accident leading death or serious injury if ignore this note and camera uses incorrectly.
 Caution	This shows, assumption for possibility of bear the damage or physical damage if ignore this note and camera uses incorrectly.

About Graphic symbols



This symbol shows general prohibition.











This symbol shows completion or instruction.



[Environment / condition]

 Warning	
 Do not use flammable or explosiveness atmospheres. This will cause of personal injury or fire.	 Do not use for "safety for human body" related usage. This camera is designed for use "do not harm human body immediately" if by any chance the camera has malfunction.
 Caution	
 Use and store under specified environmental conditions (Vibration, shock, temperature, humidity) in the specifications for this camera. This will cause of fire or damage the camera.	









[Installation and cable wiring]

 Warning	
 Do not use with out of power voltage range that is specified in the specifications for this camera. This will cause of fire, electrification or malfunction.	 Do not wrong wiring. This will cause of fire or malfunction.
 Caution	
 Do not grounding DC power (+) of all devices that are connect to the camera. The camera housing is connecting to 0 V line of camera inside circuit. There is a risk of short circuit between camera inside ciurcuit and frame ground. This will cause of malfunction.	 It is necessary to wiring and mounting that is specified in the specifications for this camera. This will cause of fire or malfunction.
 It is necessary to wiring with turn off the camera. This will cause of electrification or malfunction.	 It is necessary to mounting the camera without stress for the cable. This will case of electrification or fire.



[Installation and cable wiring]

 Caution	
 Do not use CoaXPress un-supported cable and board. There is a risk of malfunction if the camera connects with wrong environment and turn on the camera.	



[Usage instruction]

 Warning	
 Do not touch the terminal and PCB board While turn on the camera. This will cause of electrification or accident caused by malfunction.	 Do not put combustibles near the camera. This will cause of fire.
 Do not use without usage that is specified in the specifications for this camera. This will cause of personal injury or malfunction.	 Do not push metals including screw driver into radiation holes. This will cause of electrification or malfunction.
 Caution	
 Do not push contamination into opening of the camera. This will cause of electrification or malfunction.	 Do not block the radiation holes. This will cause of fire due to increase the camera inside temperature.



[Maintenance]

 Caution	
 Do not disassemble or repair the camera. This will cause of fire, electrification or malfunction.	 It is turn off the camera when maintaining or inspecting the camera. This will cause of electrification.

[Disposal]

 Caution	
 It is necessary to dispose as industrial waste. In EU, it is necessary to dispose of accordance with WEEE directive. 	

[Security Measures, Anti-virus protection]

 Warning	
 Install the latest commercial-quality antivirus software on the computer connected to the control system and maintain to keep the software up-to-date.	

1 Product Precautions

Do not give shock to the camera.

Do not haul or damage the camera cable.

Do not wrap the camera with any material while using the camera. This will cause the internal camera temperature to increase.

When the camera moving or using the place that temperature difference is extreme, countermeasure for dew condensation (heat removal / cold removal) is necessary.

While the camera is not using, keep the lens cap on the camera to prevent dust or contamination from getting in the sensor or filter and scratching or damaging it.

Do not keep the camera under the following conditions.

In wet, moist, high humidity or dusty place

Under direct sunlight

In extreme high or low temperature place

Near an object that releases a strong magnetic or electric field

Place with strong vibrations

Apply the power that satisfies the specified in specifications for the camera.

The defective pixels may appear due to the sensor characteristics.

Use below recommend materials (or equivalent materials) to clean the surface of glass.

Air dust: Non Freon air duster (NAKABAYASHI Co., LTD.)

Alcohol: Propan-2-ol (SAN'EI KAKO Co., LTD.)

Non-woven: nikowipe clean room (NKB)

Use a soft cloth to clean the camera.

2 Product conformity / compliance

Please confirm regulation in each country by responsibility of exporter and importer when exporting this product from Japan.

3 Warranty

■ Warranty period

One year after delivery (However, the camera had malfunction with camera uses correctly)

In below case for a fee even within warranty period.

- The malfunction caused by incorrect usage, incorrect modify or repair.
- The malfunction caused by external shock including the camera dropping after delivery the camera.
- The malfunction caused by fire, earthquake, flood disaster, thunderbolt struck, other natural disaster or wrong voltage.

■ Warranty coverage

Exchange or repair the malfunction camera if the malfunction is occurred by our responsibility.

“Warranty” mean is warranty for the delivered camera itself. Please accept the induction damage by the camera malfunction is not included.

4 Overview

This document describes the specifications of the following cameras

STC-CMB120ACXP / STC-CMC120ACXP / STC-CMB120ACXP-F / STC-CMC120ACXP-F
STC-CMB120ACXP-T / STC-CMC120ACXP-T / STC-CMB120ACXP-T-F / STC-CMC120ACXP-T-F

4.1 Features

- CoaXPress (CXP) Interface (Dyanamically Configurable)
- Maximum frame rate (Full resolution): 186 fps @ 12M 8bits
- CMOS Global Shutter
- Up to 600 Pixel Defect Correction (Default: ON)
- M42 mount (convert to F mount with "M42-F mount adaptor")

4.2 Product Number Naming Method

STC-CMx120ACXP-F

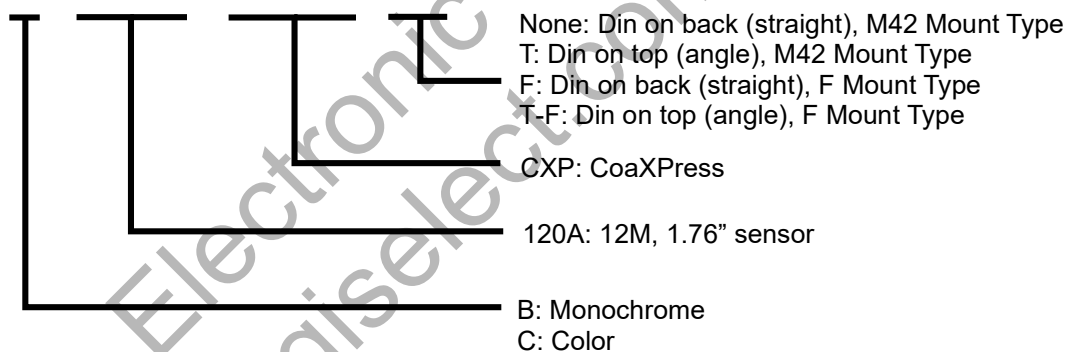

5 Specifications

5.1 Electronic Specifications

Model Number	STC-CMB120ACXP / STC-CMB120ACXP-T / STC-CMB120ACXP-F / STC-CMB120ACXP-T-F	STC-CMC120ACXP / STC-CMC120ACXP-T / STC-CMC120ACXP-F / STC-CMC120ACXP-T-F
Image Sensor	1.76" 12M Progressive Monochrome CMOS (CMOSIS: CMV12000)	1.76" 12M Progressive Color CMOS (CMOSIS: CMV12000)
Shutter Type	Global	
Active Picture Elements	4,096 (H) x 3,072 (V)	
Cell Size	5.5 (H) x 5.5 (V) μm	
Sync System	External trigger (Hardware, Software) / Free run	
Frame Rate (Full resolution)	8bits 4-Lane 8bits 2-Lane 8bits 1-Lane	186.9 fps 93.4 fps 46.7 fps
Image Format	Mono 8bits	Bayer 8bit (BayerGR8)
CoaXPress Data Output Type	CXP-6 (6.25Gbps) 4-Lane / 2-Lane / 1-Lane	
Noise Level (8bits 1-Lane)	Less than 3.5 digits (Gain 0 dB)	
Sensitivity (*1)	370 Lux	740 Lux
Exposure Time	8bits 4-Lane 8bits 2-Lane 8bits 1-Lane	16 $\mu\text{seconds}$ to 16.777 seconds (Default: 5,283 $\mu\text{seconds}$) 16 $\mu\text{seconds}$ to 16.777 seconds (Default: 5,300 $\mu\text{seconds}$) 16 $\mu\text{seconds}$ to 16.777 seconds (Default: 5,300 $\mu\text{seconds}$)
Gain	Analog Gain Digital Gain	x1, x2 or x3 x1 to x5
Black Level	0 to 30 digits	
White Balance Gain	N/A	0 (Black level) to x4 (Default: x1)
ROI	Horizontal: 256 to 4,096 (pixels) / Vertical: 2 to 3,072 (lines) (Default: 4,096 x 3,072) Adjustable steps for size: Horizontal: 16 pixels / Vertical: 4 lines Adjustable steps for offset: Horizontal: 2 pixels / Vertical: 4 lines	
Multi ROI	N/A	
Gamma	0.1 ~ 3.2 (Default: 1.0)	1.0
HDR	Support	N/A
Binning	N/A	
Decimation	N/A	
Image Flip	Horizontal / Vertical / Horizontal and Vertical / Off	
Defective Pixel Correction	Up to 600 points	
Auto Image Control	Auto Exposure Auto Gain Auto White Balance	N/A N/A N/A
Operational Mode	Edge Preset Trigger / Pulse Width Trigger / CXP Trigger Packet / Free run	
Communication Protocol	Protocol: CoaXPress Standard Version 1.1 Interface: GenICam	
Input / Output	3 GPIOs	
Power	Input Voltage (*2) Consumption	PoCXP / Power/IO connector (+18.5 to +26 Vdc) Max: Less than 10 W, Typical: 9 W

Default: **Bold**

Precautions

*1: The sensitivity is measured the light source illumination for 100 % white under below conditions:

Camera Setting		Environment	
Parameter	Setting	Parameter	Setting
Gain Up	0 dB	Light Source	Light Box (White)
AGC	Off	Color temperature	5,100K
White Balance	Optimum	Lens	
Electrical Shutter	1/30 seconds	F on Lens	F5.6
Black Level	Optimum	Target Luminance	IM-600 (Topcon)
Gamma	Factory Setting		

*2: When CH1 was connecting with Frame Grabber (FG), then FG provides camera power through PoCXP. Some FG start discovery process when CH1 was connected. In this case camera may not be recognized as CXP-6 (6.25Gbps) 4 Lane camera. To recognize as CXP-6(6.25Gbps) 4 Lane camera, please connect CH1 after connected CH2, CH3, CH4, or run discovery process again after connected all CHs.

5.2 Spectral Sensitivity Characteristics

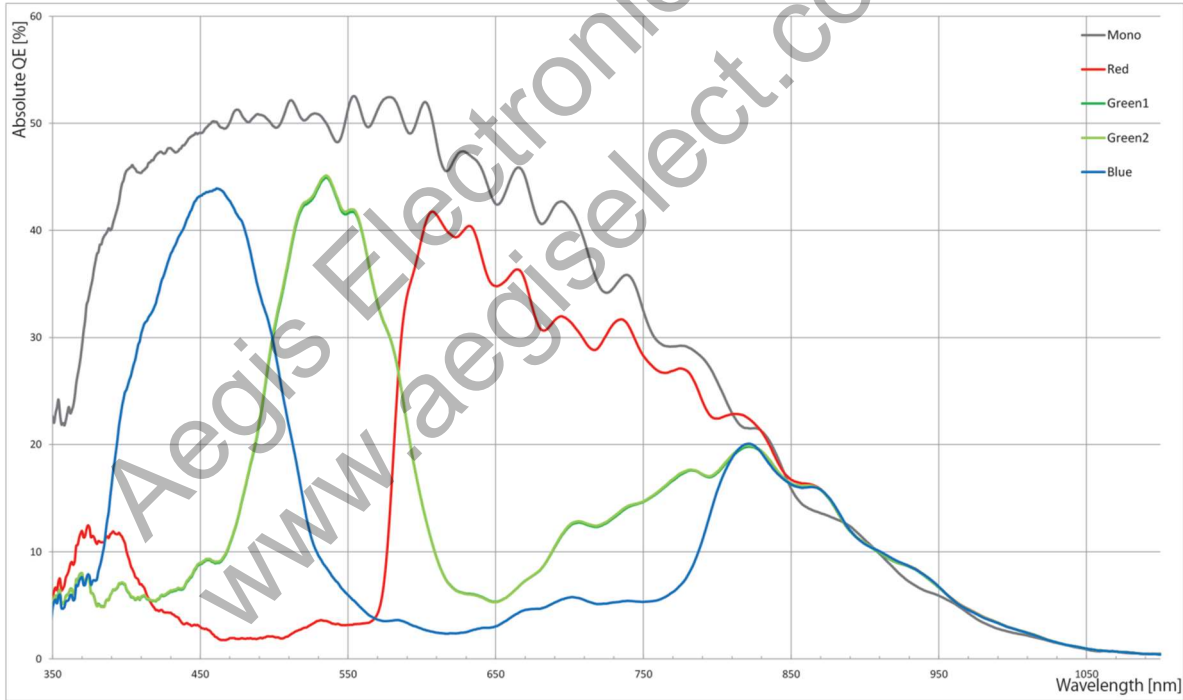

5.3 Mechanical Specifications

5.3.1 STC-CMB120ACXP / STC-CMC120ACXP / STC-CMB120ACXP-T / STC-CMC120ACXP-T

Model Number	STC-CMB120ACXP / STC-CMC120ACXP	STC-CMB120ACXP-T / STC-CMC120ACXP-T
Dimensions	68 (W) x 68 (H) x 40 (D) mm (*1)	68 (W) x 68 (H) x 46 (D) mm (*1)
Optical filter	No Optical Filter	
Material	Aluminum alloy	
Lens mount	M42 Mount: M42 × P1.0, FB = 10.0 mm (in Air)	
Interface connector	CXP connector: "DIN1.0/2.3, 75 Ohm Jack" x 4 Power/IO connector: HR10A-7R-6PB (Hirose) or equivalent x 1	
Camera Mounting	M4 screw holes (Four on front, top, bottom and both sides)	M4 screw holes (Four on front, bottom and both sides, two on top)
Weight	Approximatly 320 g	

(*1) Excluding connectors

5.3.2 STC-CMB120ACXP-F / STC-CMC120ACXP-F / STC-CMB120ACXP-T-F / STC-CMC120ACXP-T-F

Model Number	STC-CMB120ACXP-F / STC-CMC120ACXP-F	STC-CMB120ACXP-T-F / STC-CMC120ACXP-T-F
Dimensions	68 (W) x 68 (H) x 76.5 (D) mm (*1)	68 (W) x 68 (H) x 82.5 (D) mm (*1)
Optical filter	No Optical Filter	
Material	Aluminum alloy	
Lens mount	F Mount	
Interface connector	CXP connector: "DIN1.0/2.3, 75 Ohm Jack" x 4 Power/IO connector: HR10A-7R-6PB (Hirose) or equivalent x 1	
Camera Mounting	M4 screw holes (Four on front, top, bottom and both sides)	M4 screw holes (Four on front, bottom and both sides, two on top)
Weight	Approximatly 395 g	

(*1) Excluding connectors

5.4 Environmental specifications

Model Number	STC-CMB120ACXP / STC-CMB120ACXP-T / STC-CMB120ACXP-F / STC-CMB120ACXP-T-F	STC-CMC120ACXP / STC-CMC120ACXP-T / STC-CMC120ACXP-F / STC-CMC120ACXP-T-F
Operational Temperature / Humidity	Environmental Temperature: 0 to +40 deg. C (*1), Environmental Humidity: 20 to 85 %RH (No condensation)	
Storage Temperature / Humidity	Environmental Temperature: -30 to +65 deg. C, Environmental Humidity: 20 to 85 %RH (No condensation)	
Vibration	20 Hz to 200 Hz to 20 Hz (5 min. / cycle), acceleration 10 G, XYZ 3 directions 30 min. each	
Shock	Acceleration 38 G, half amplitude 6 ms, XYZ 3 directions 3 times each	
Standard Compliancy	EMS: EN61000-6-2, EMI: EN55011	
RoHS	RoHS Compliant	

(*1) Please install the camera with appropriate heat dissipation. If camera is mounted lens and tripod like aluminum plate, it could decrease the camera housing temperature for heat dissipation. When internal temperature sensor on the camera shows less than 68 deg C, camera housing temperature (top plate) would be less than 60 deg. It could be the guideline.

Upper side of camera

Measuring point

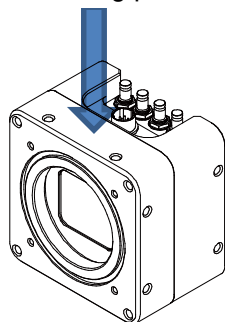

5.5 Connector Specifications

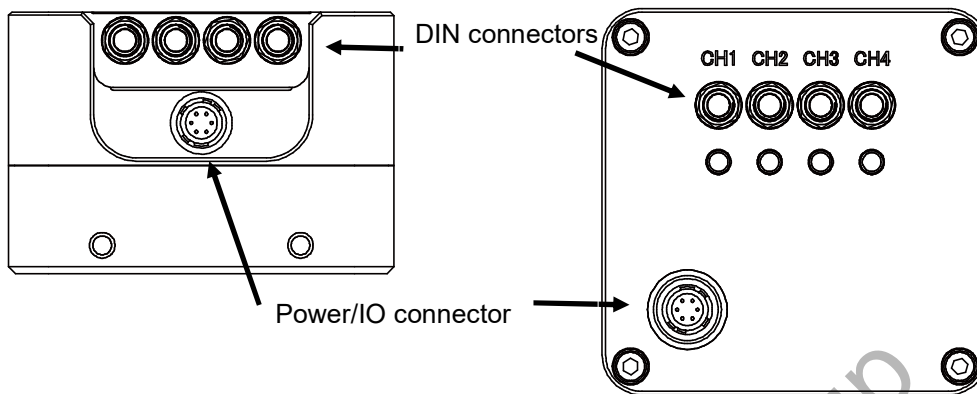

5.5.1 DIN Connector

DIN (TO-CONNE) (DIN1.0/2.3, Jack, 75 Ohm) or equivalent x 4
This product is PoCXP compliant.
The power supplies through PoCXP supported frame grabber board.

5.5.2 Power/IO Connector

HR10A-7R-6PB (Hirose) or equivalent.

This connector is for external power input, input and output signals.

The trigger input and sync input/output signals can be assigned through the camera setting communication. As for the cable part (Female connector), HR10A-7P-6S (Hirose) or equivalent can be used.

The power of camera can be supply from IO connector.

Pin assignment

Pin No.	Signal Name	IN/OUT
1	GND	-
2	GPIO2	IN/OUT
3	GPIO1	IN/OUT
4	GPIO0	IN/OUT
5	NC	-
6	POWER	IN

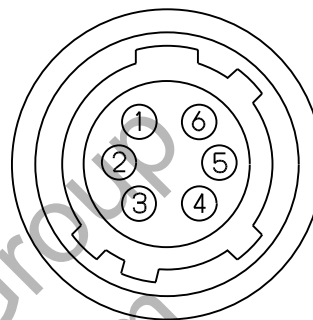

* Possible Maximum Rated Voltage is +24 V on GPIO0, GPIO1 and GPIO2.

* Please set electrically "OPEN" on NC (Pin 6).

Input Output DC characteristics

Pin No.	Signal Name	Function	IN/OUT	Voltage		Current	Reference	
				Low Voltage	High Voltage			
1	GND	GND	-	-	-	-	-	
2	GPIO2	General Purpose Input Output	IN/OUT	IN	Less than +1.00 V	+3.00 to +24 V	4 μ A (typ.) (*4)	1
				OUT	0 to +2.20 V (*1)	+3.00 to +24 V (*2)	15 mA (Max.) (*3)	2, 3
3	GPIO1	General Purpose Input Output	IN/OUT	IN	Less than +1.00 V	+3.00 to +24 V	4 μ A (typ.) (*4)	1
				OUT	0 to +2.20 V (*1)	+3.00 to +24 V (*2)	15 mA (Max.) (*3)	2, 3
4	GPIO0	General Purpose Input Output	IN/OUT	IN	Less than +1.00 V	+3.00 to +24 V	4 μ A (typ.) (*4)	1
				OUT	0 to +2.20 V	+3.00 to +24 V (*2)	15 mA (Max.) (*3)	2, 3
5	N.C.	NC	-	-	-	-	-	
6	POWER	External Power	IN	+18.5 to +26 V		-	-	

(*1): If the current on the IO port is at 15mA when using low voltage output, the output voltage could increase for the internal register.

(*2): This is the maximum charging voltage when the external IO port is connected.

(*3): When the external IO port is connected, control the current less than 15 mA on the IO port.

(*4): This value is the typical current value of the Input Port when High Voltage is input.

Default Setting of Input Output

Pin No.	Signal Name	Default	
		IN/OUT	Setting
2	GPIO2	IN	Disable
3	GPIO1	IN	Disable
4	GPIO0	IN	Disable

5.5.3 GPIO Circuit (Input)

Input Signal Functions

No.	Function	Polarity
1)	Disable (Default)	-
2)	General Input	-
3)	Trigger Input	Positive or Negative

- 1) Disable
This function should be set when no input signal is necessary.
- 2) General Input
This function can set high or low level and the user can use this to check the status on the software.
- 3) Trigger Input
This function is used for the trigger signal in the edge preset mode.

General Purpose Input (Reference 1)

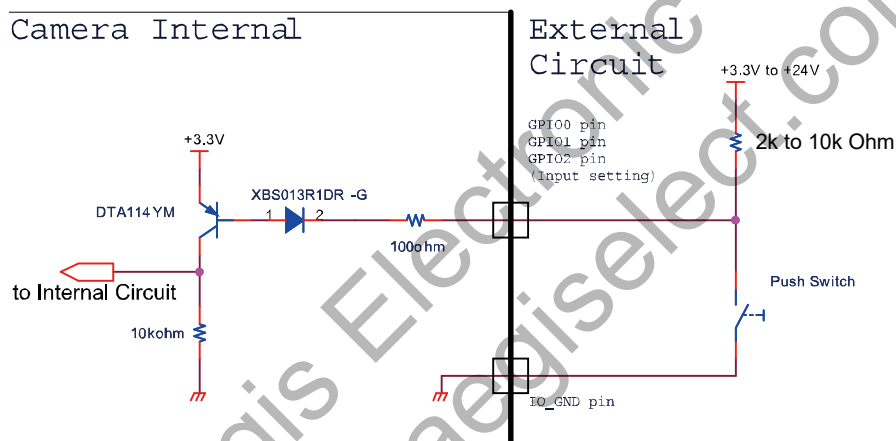

Input Response Characteristics

The following table and timing chart show the Input Response Characteristics (Reference1).

Td	0.09 μseconds
Tr	0.07 μseconds
Ts	3.30 μseconds
Tf	1.50 μseconds

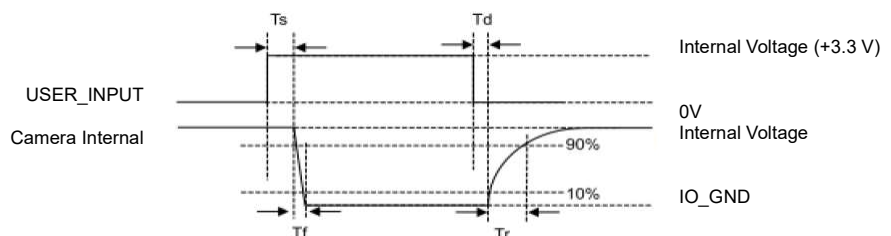

Required pulse width is
 Positive signal: More than $T_s + T_f$
 Negative signal: More than $T_d + T_r$

5.5.4 GPIO Circuit (Output)

Output Signal Functions

No/	Function	Polarity
1)	Disable (Default)	-
2)	General Output (UserOutput0 / 1 / 2)	-
3)	Frame End	Positive or Negative
4)	Exposure Active	Positive or Negative

- 1) Disable
This function should be set when no output signal is necessary.
- 2) General Output (UserOutput0 / 1 / 2)
This function outputs high or low level signals set on the software.
- 3) Frame End
This function outputs when exposure ended with the pulse delay setting and pulse duration applied.
- 4) Exposure Active
This function outputs the High or Low signal while in actual exposure time.

General Purpose Output (Reference 2)

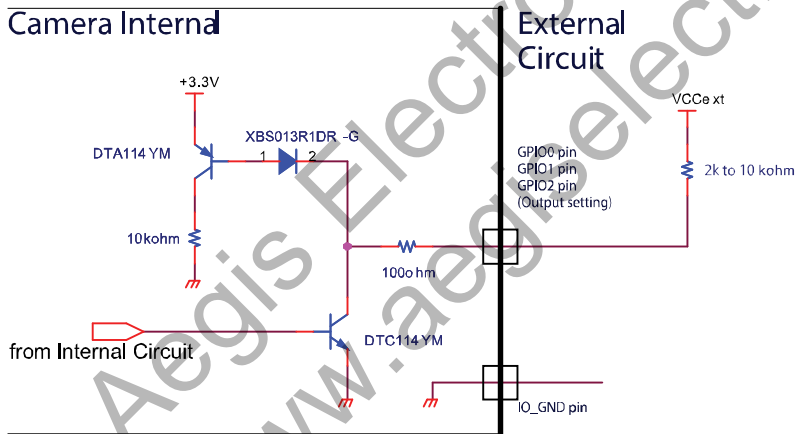

General Purpose Output (Reference 3)

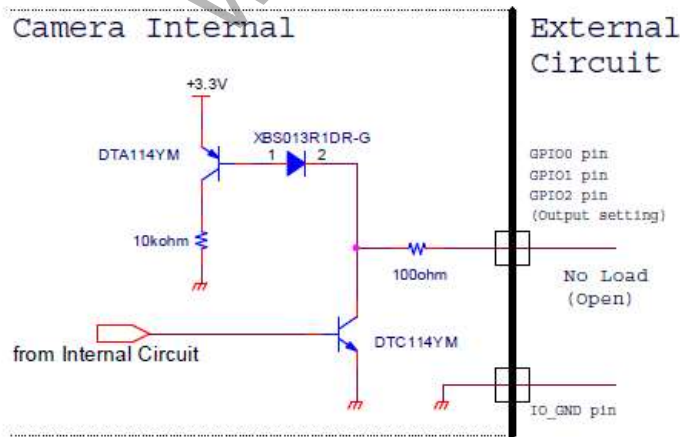

Characteristics of the output signals

Response characteristics of the General Purpose output (Reference 2), and General Purpose output (Reference 3) are shown in the diagram below. Pulse width is configurable through software. Please refer to the following response timing in the table.

	VCCext			
	OPEN (*1)	5 V (*2)	12 V (*2)	24 V (*2)
Td	1.82 μ seconds	1.72 μ seconds	1.77 μ seconds	1.72 μ seconds
Tr	8.58 μ seconds	0.97 μ seconds	0.91 μ seconds	0.89 μ seconds
Ts	0.11 μ seconds	0.12 μ seconds	0.14 μ seconds	0.15 μ seconds
Tf	0.10 μ seconds	0.13 μ seconds	0.23 μ seconds	0.36 μ seconds

*1: Reference 2. Measured on +1.8 V internal Voltage.

*2: Reference 3

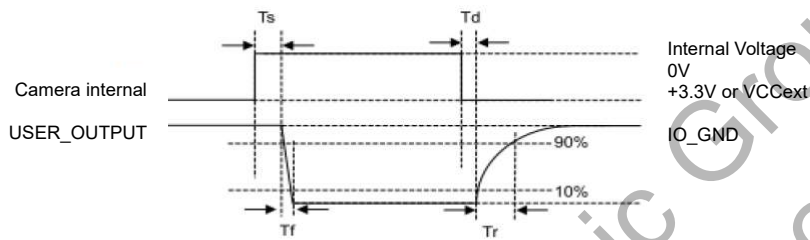

5.6 Conector Indicator Lamps (LED) Specifications

Conector indicator LED exists beside of each DIN connector.

Each LED informs each status of communication. The detail of status is as following table.

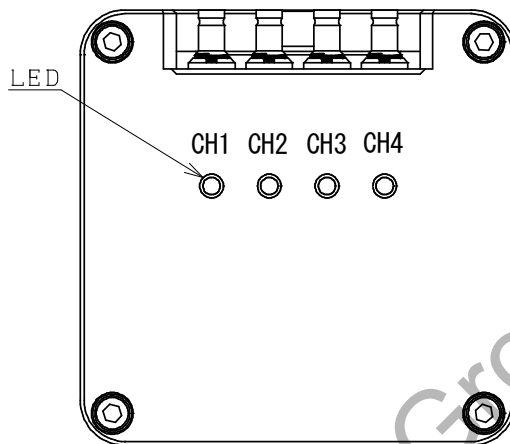

Status	LED Blinking Pattern
No connection	Off
System booting	Solid orange
External powered, but no CXP connection	RED slow blinking
PoCXP connection	Fast flash alternating green / orange shown for a minimum
CXP connection with external power	Fast flash orange
Device / Host connected, but no data being transferred	Solid green
Device / Host incompatible, PoCXP	Slow flash alternating red / green
Device / Host incompatible, CXP with external power	Slow flash alternating red / orange
Device / Host connected, waiting for trigger	Slow flash orange
Device / Host connected, data being transferred	Fast flash green
Data Transfer Error	Solid red (500 mseconds)
System Error	Red fast blinking

6 Dimensions

6.1 STC-CMB120ACXP / STC-CMC120ACXP / STC-CMB120ACXP-F / STC-CMC120ACXP-F

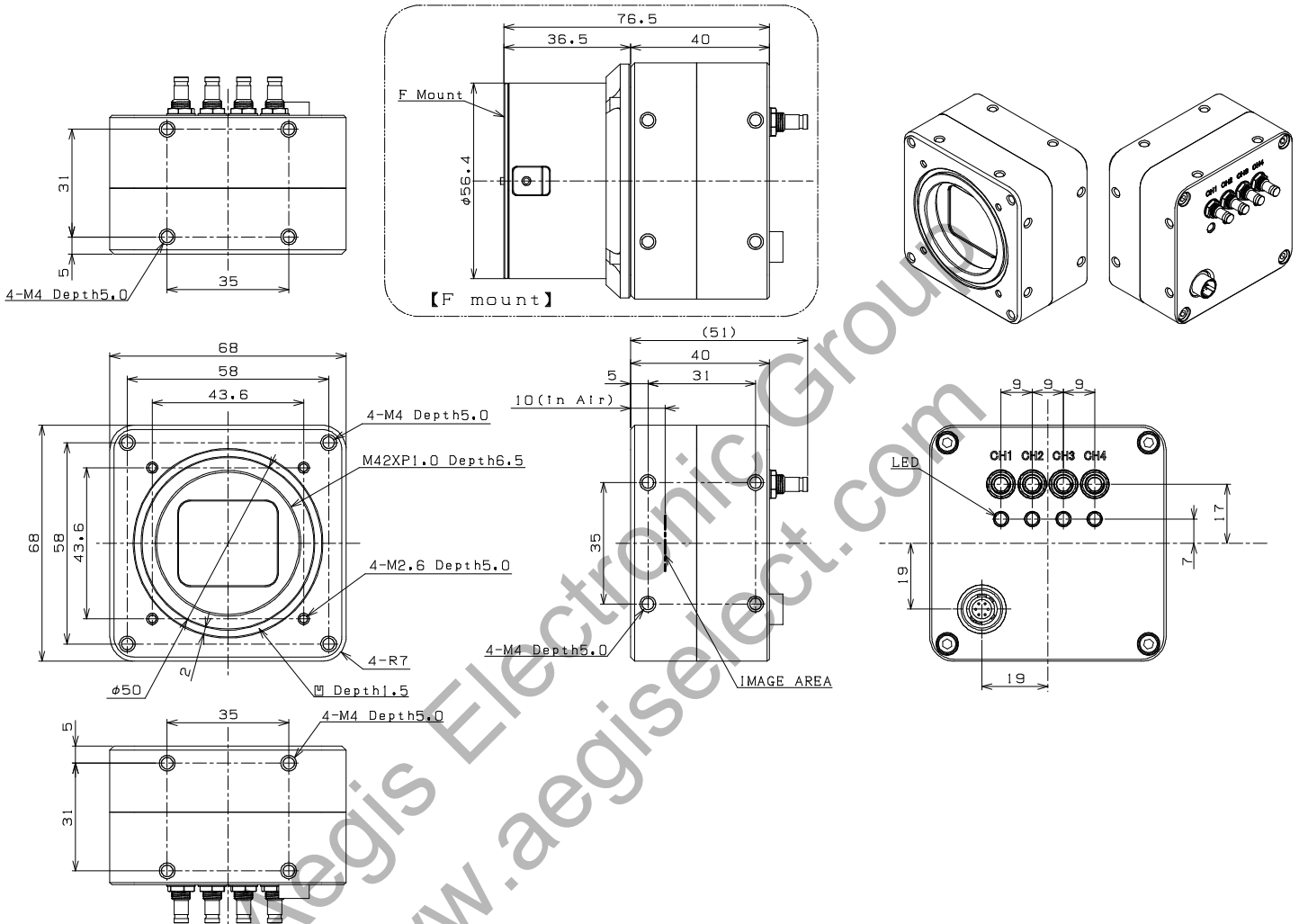

Unit: mm

6.2 STC-CMB120ACXP-T / STC-CMC120ACXP-T / STC-CMB120ACPX-T-F / STC-CMC120ACXP-T-F

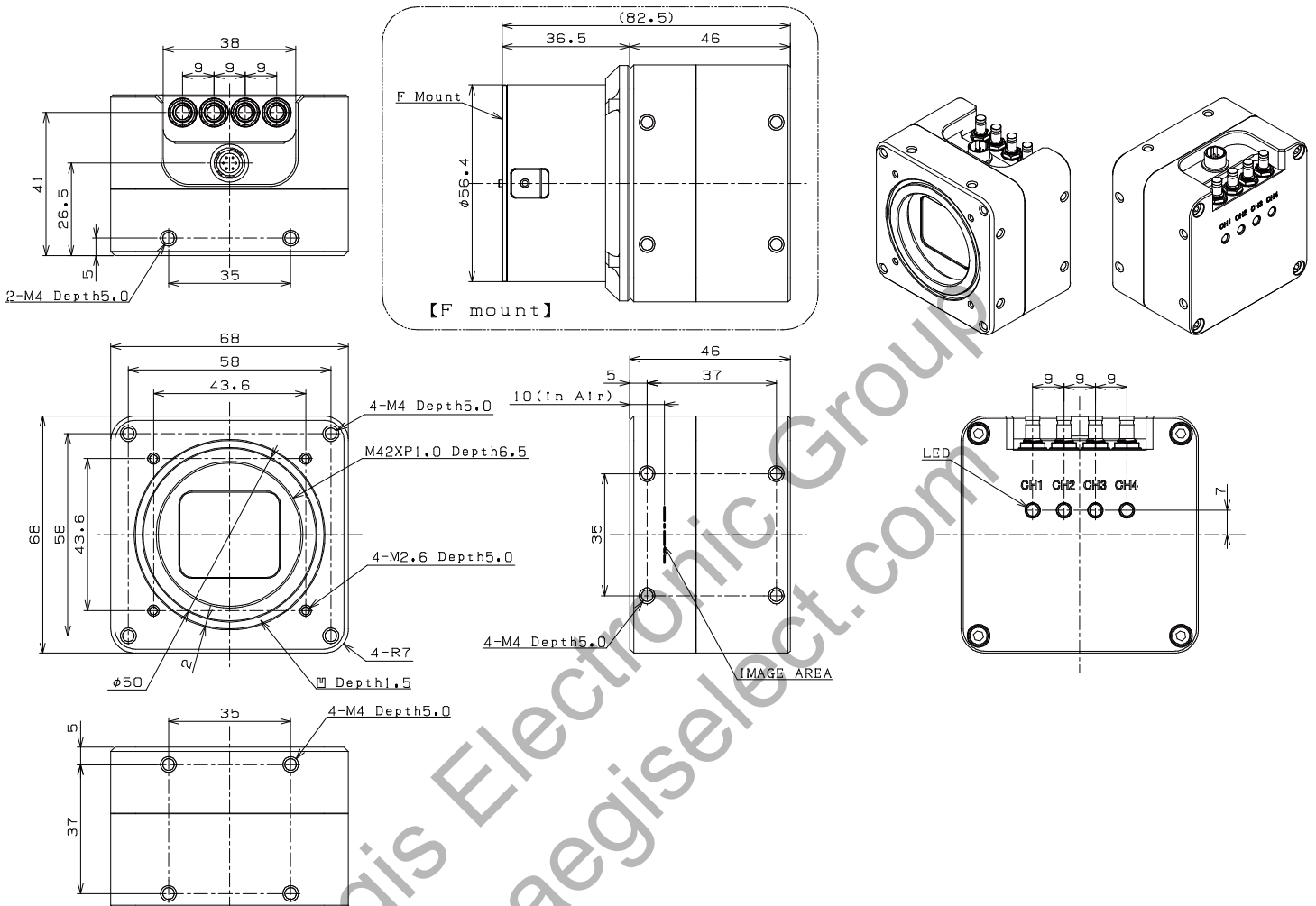

Unit: mm

7 Camera operation

7.1 Frame rate calculation fomula

The frame rate can be changed by changing number of variable lines (hight).
The frame rate on configured number of line (hight) is as following formula.

$150 / 258 / (\text{Variable number of vertical linesr} + 38) \times 1,000,000$ [fps] (Round down to 1 deciaml palces)

* The variable number of vertical lines: Unit 4 lines (Minimum is 4 lines)

* The frame rate does not change even number of horizontal pixel is redouced.

[Reference information]

The frame rate on Minimum ROI (256 (H) x 4 (V)) is 13,842.7 [fps]

Aegis Electronic Group
www.aegiselect.com

7.2 Saving and Loading a data

This camera can save and load the camera parameters. It is included restoring the factory defaults. There are two kind of data are existing.

Default: The factory defaults data
UserSet1: User accessible data for saving

The data is loaded and written into in the register on RAM of camera. These functions can be accessed through the parameters (UserSetSelector, UserSetDefault) and commands (UserSetLoad, UserSetSave) on UserSetControl category of GenICam.

For the descriptions of the parameters and commands, please see the table as follow.

GenICam parameters

UserSetSelector	Enumeration	Selects the feature User Set to load from "Default", "UserSet1"
UserSetDefault	Enumeration	Selects the feature User Set to load and make active by default "Default", "UserSet1" from when the device is reset
UserSetLoad	Command	Loads the User Set specified by UserSetSelector to the device and makes it active
UserSetSave	Command	Save the User Set specified by UserSetSelector to the non-volatile memory of the device

7.2.1 Save Setting

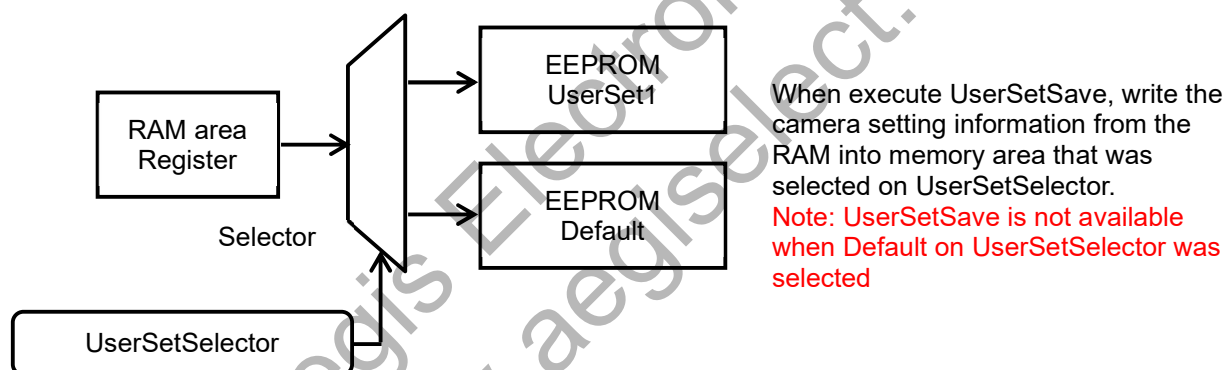

Setting Procedure

1. Set UserSet1 on the UserSetSelector
2. Execute UserSetSave

7.2.2 Load Setting

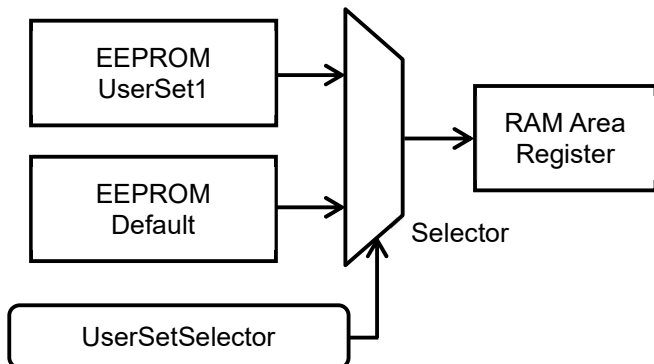

When execute UserSetLoad, write the camera setting information from the RAM into memory area that was selected on UserSetSelector.

Setting Procedure

1. Set UserSet1 or Default on UserSetSelector
2. Execute UserSetLoad

7.2.3 Camera startup

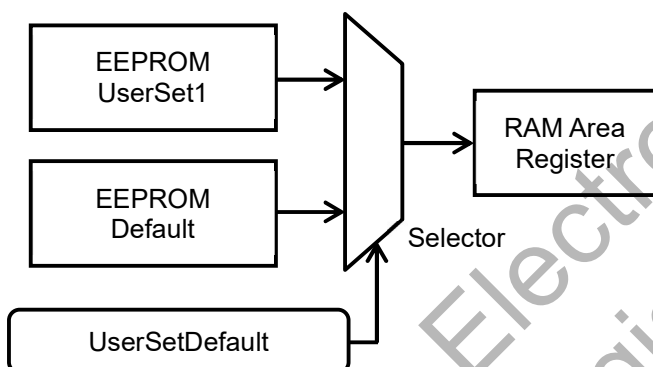

When startup camera, write camera setting information from memory area into the RAM.

Setting Procedure

1. Set UserSet1 or Default on UserSetDefault

7.2.4 Camera initialization

In order to initialize camera setting, please follow the procedure as bellow.
Write Defalut into UserSet1.

Setting Procedure

1. Set Default on UserSetSelector
2. Execute UserSetLoad
3. Set UserSet1 on UserSetSelector
4. Execute UserSetSave

7.3 GenICam command

7.3.1 DeviceControl

Name	Description
DeviceType	Returns the device type.
DeviceScanType	Scan type of the sensor of the device.
DeviceVendorName	Name of the manufacturer of the device.
DeviceModelName	Model of the device.
DeviceFamilyName	Identifier of the product family of the device.
DeviceManufacturerInfo	Manufacturer information about the device.
DeviceVersion	Version of the device.
DeviceFirmwareVersion	Version of the firmware in the device.
DeviceSerialNumber	Device's serial number. This string is a unique identifier of the device.
DeviceUserID	User-programmable device identifier.
DeviceSFNCVersionMajor	Major version of the Standard Features Naming Convention that was used to create the device's GenICam XML.
DeviceSFNCVersionMinor	Minor version of the Standard Features Naming Convention that was used to create the device's GenICam XML.
DeviceSFNCVersionSubMinor	Sub minor version of Standard Features Naming Convention that was used to create the device's GenICam XML.
DeviceManifestEntrySelector	Selects the manifest entry to reference.
DeviceManifestXMLMajorVersion	Indicates the major version number of the GenICam XML file of the selected manifest entry.
DeviceManifestXMLMinorVersion	Indicates the minor version number of the GenICam XML file of the selected manifest entry.
DeviceManifestXMLSubMinorVersion	Indicates the sub minor version number of the GenICam XML file of the selected manifest entry.
DeviceManifestSchemaMajorVersion	Indicates the major version number of the schema file of the selected manifest entry.
DeviceManifestSchemaMinorVersion	Indicates the minor version number of the schema file of the selected manifest entry.
DeviceManifestSchemaSubMinorVersion	Indicates the sub minor version number of the schema file of the selected manifest entry.
DeviceTLType	Transport Layer type of the device.
DeviceTLVersionMajor	Major version of the Transport Layer of the device.
DeviceTLVersionMinor	Minor version of the Transport Layer of the device.
DeviceTLVersionSubMinor	Sub minor version of the Transport Layer of the device.
DeviceCharacterSet	Character set used by the strings of the device's bootstrap registers.
DeviceReset	Resets the device to its power up state.
DeviceRegistersEndianness	Endianness of the registers of the device.
DeviceTemperatureSelector	Selects the location within the device, where the temperature will be measured.
DeviceTemperature	Device temperature in degrees Celsius (C). It is measured at the location selected by DeviceTemperatureSelector.

7.3.2 ImageFormatControl

Name	Description
SensorWidth	Effective width of the sensor in pixels.
SensorHeight	Effective height of the sensor in pixels.
SensorShutterMode	Sets the shutter mode of the device.
WidthMax	Maximum width of the image (in pixels). The dimension is calculated after horizontal binning, decimation or any other function changing the horizontal dimension of the image.
HeightMax	Maximum height of the image (in pixels). This dimension is calculated after vertical binning, decimation or any other function changing the vertical dimension of the image.
RegionSelector	Selects the Region of interest to control. The RegionSelector feature allows devices that are able to extract multiple regions out of an image, to configure the features of those individual regions independently.
ImageComponentSelector	Selects a component to activate data streaming from.
ImageComponentEnable	Controls if the selected component streaming is active.
Width	Width of the image provided by the device (in pixels).
Height	Height of the image provided by the device (in pixels).
OffsetX	Horizontal offset from the origin to the region of interest (in pixels).
OffsetY	Vertical offset from the origin to the region of interest (in pixels).
PixelFormat	Format of the pixels provided by the device. It represents all the information provided by PixelCoding, PixelSize, PixelColorFilter combined in a single feature.
PixelFormatInfoSelector	Select the pixel format for which the information will be returned.
PixelFormatInfoID	Returns the value used by the streaming channels to identify the selected pixel format.
PixelSize	Total size in bits of a pixel of the image.
PixelColorFilter	Type of color filter that is applied to the image.
TestPatternGeneratorSelector	Selects which test pattern generator is controlled by the TestPattern feature.
TestPattern	Selects the type of test pattern that is generated by the device as image source.
ReverseX	This feature is used to flip horizontally the image sent by the device. The AOI is applied after the flipping.
ReverseY	This feature is used to flip vertically the image sent by the device. The AOI is applied after the flipping.

7.3.3 AcquisitionControl

Name	Description
AcquisitionMode	Sets the acquisition mode of the device. It defines mainly the number of frames to capture during an acquisition and the way the acquisition stops.
AcquisitionStart	Starts the Acquisition of the device. The number of frames captured is specified by AcquisitionMode.
AcquisitionStop	Stops the Acquisition of the device at the end of the current Frame. It is mainly used when AcquisitionMode is Continuous but can be used in any acquisition mode.
AcquisitionFrameRate	Controls the acquisition rate (in Hertz) at which the frames are captured.
TriggerSelector	Selects the type of trigger to configure.
TriggerMode	Controls if the selected trigger is active.
TriggerSoftware	Generates an internal trigger. TriggerSource must be set to Software.
TriggerSource	Specifies the internal signal or physical input Line to use as the trigger source. The selected trigger must have its TriggerMode set to On.
TriggerDelay	Specifies the delay in microseconds (us) to apply after the trigger reception before activating it.
ExposureMode	Sets the operation mode of the Exposure (or shutter).
ExposureTimeSelector	Selects which exposure time is controlled by the ExposureTime feature. This allows for independent control over the exposure components.
ExposureTime	Sets the Exposure time when ExposureMode is Timed and ExposureAuto is Off. This controls the duration where the photosensitive cells are exposed to light.

7.3.4 TransportLayerControl

Name	Description
CxpLinkConfigurationStatus	This feature indicates the current and active link configuration used by the device.
CxpLinkConfigurationPreferred	Provides the link configuration that allows the Transmitter device to operate in this default mode.
CxpLinkConfiguration	This feature allows specifying the link configuration for the communication between the Receiver and Transmitter device.
CxpConnectionSelector	Selects the CoaXPress physical connection to control.
CxpConnectionTestMode	Enables the test mode for an individual physical connection of the device.
CxpConnectionTestErrorCount	Reports the current connection error count for test packets received by the device on the connection selected by CxpConnectionSelector.
CxpConnectionTestPacketCount	Reports the current count for test packets received by the device on the connection selected by CxpConnectionSelector.
PayloadSize	Provides the number of bytes transferred for each image or chunk on the stream channel. This includes any end-of-line, end-of-frame statistics or other stamp data. This is the total size of data payload for a data block.

7.3.5 DigitalIOControl

Name	Description
LineSelector	Selects the physical line (or pin) of the external device connector to configure.
LineMode	Controls if the physical Line is used to Input or Output a signal.
LineInverter	Controls the inversion of the signal of the selected input or output Line.
LineStatus	Returns the current status of the selected input or output Line.
LineSource	Selects which internal acquisition or I/O source signal to output on the selected Line. LineMode must be Output.
UserOutputSelector	Selects which bit of the User Output register will be set by UserOutputValue.
UserOutputValue	Sets the value of the bit selected by UserOutputSelector.
StrobeOutDelay	Delay of StrobeOut signal when LineSource is set to StrobeOut (us).
StrobeOutOnTime	Duration of StrobeOut signal when LineSource is set to StrobeOut (us).
TriggerOutDelay	Delay of TriggerOut signal when LineSource is set to TriggerOut (us).
TriggerOutOnTime	Duration of TriggerOut signal when LineSource is set to TriggerOut (us).
LineDebounceTime	Sets the value of the input line debouncer time.

7.3.6 AnalogControl

Name	Description
GainSelector	Selects which Gain is controlled by the various Gain features.
Gain	Controls the selected gain as an absolute physical value. This is an amplification factor applied to the video signal.
DigitalGainOffsetMode	DigitalGainOffsetMode is enabled.
BlackLevelSelector	Selects which Black Level is controlled by the various Black Level features.
BlackLevel	Controls the black level as an absolute physical value. This represents a DC offset applied to the video signal.
BalanceRatioSelector	Selects which Balance ratio to control.
BalanceRatio	Controls ratio of the selected color component to a reference color component. It is used for white balancing.
BalanceWhiteAuto	Controls the mode for automatic white balancing between the color channels. The white balancing ratios are automatically adjusted.

7.3.7 LUTControl

Name	Description
PixelCorrectionAllEnabled	Enable pixel correction for all pixels.
PixelCorrectionIndex	Determine index of targeted pixel for pixel correction.
PixelCorrectionX	Determine x-coordinate of targeted pixel for pixel correction.
PixelCorrectionY	Determine y-coordinate of targeted pixel for pixel correction.
PixelCorrectionEnabled	Determine if targeted pixel is enabled for pixel correction.

7.3.8 UserSetControl

Name	Description
UserSetSelector	Selects the feature User Set to load, save or configure.
UserSetLoad	Loads the User Set specified by UserSetSelector to the device and makes it active.
UserSetSave	Save the User Set specified by UserSetSelector to the non-volatile memory of the device.
UserSetDefault	Selects the feature User Set to load and make active by default when the device is reset.

Aegis Electronic Group
www.aegiselect.com

8 Revision History

Rev	Date	Changes	Note
00	2015/06/01	● Released: Production model	
01	2015/08/17	● Revised Added shutter speed and ROI	
02	2015/12/10	● Revised Added Formura of Frame rate	
03	2016/05/23	● Revised Maximum framerate as 1 86fps, and CE certifications Weight, Maximum and Typical Power consumption were described Input Response Characteristics, Dimensions Product model name	
04	2016/08/02	● Revised CE certificated	
05	2017/04/28	● Revised New office information Added Power pin connector information on 6Pin Added frame rate of 2-Lane and 1-Lane	
06	2017/07/03	● Revised Change the name of company	
07	2017/09/07	● Revised Add the camera mounting	
08	2018/12/13	● Revised Add GenICam commands	
09	2021/01/15	● Revised Revised the external power input through 6pin connector	
10	2021/05/28	● Revised Conformed WEEE directive Added "Product conformity / compliance"	
11	2022/08/09	● Revised Revised maximum Black Level (20 to 30) Added "Security Measures, Anti-virus protection" at "Precautions for safety"	
12	2022/12/02	● Revised Revised gamma control for monochrome models	
13	2023/08/07	● Revised Revised image format on electronic specifications	

Note: Product specifications would be changed without notification.

CoaXPress is registered trademarks of JIIA (Japan Industrial Imaging Association)

GenICam is trademark of EMVA.

Other company names and product names in this document are trademarks of their respective owners.

Aegis Electronic Group
www.aegiselect.com