

CIS

CoaXPress I/F
120M pixels CMOS B/W Camera

VCC-120CXP1M

Product Specifications & Operational Manual

CIS Corporation

Table of Contents

1.	Handling Precautions	2
1.1.	Camera Handling Precautions	2
1.2.	Restrictions on Applications	2
1.3.	Disclaimers (Exception Clause)	3
2.	Product Outline	3
2.1.	Features	3
2.2.	Accessories	3
3.	Specifications	4
3.1.	General Specifications	4
3.2.	Input and Output Specifications	5
3.2.1	Trigger Input (12pins circular connector, No.11 pin)	5
3.2.2	Exposure/Strobe Output (12pins circular connector, No.9 pin)	5
3.2.3	FVALL_OUT/LVAL_OUT (12pins circular connector No. 6, 7, and 10 pin)	5
3.3.	External Connector Pin Assignment	6
3.3.1	12pins Circular Connector HR10-10R-12PA (73) (HIROSE) or Equivalent	6
3.3.2	75Ω DIN Connector (Quad type/Dual type)	6
3.3.3	LED Indicator	6
3.4.	Spectral Response	7
4.	Camera Functions	8
4.1.	Camera Interface	8
4.2.	Camera Information	8
4.3.	LED Operational Mode	8
4.4.	Partial Scan (ROI)	9
4.5.	Pixel Format	10
4.6.	Cursor Indication	10
4.7.	Test Pattern Indication	10
4.8.	Trigger Mode	11
4.8.1	Internal Sync Mode (Free Run Mode)	12
4.8.2	External Sync Mode	13
4.9.	Strobe Pulse Control	15
4.10.	Exposure Time	16
4.11.	Gain	16
4.12.	Black Level Adjustment	17
4.13.	Shading Correction	17
4.14.	Defective Pixel Correction	18
4.15.	Noise Filter	18
4.16.	Link Speed and Link Count	19
4.17.	How to Save and Initialize Settings	19
5.	Factory Settings	20
6.	Dimensions	21
6.1.	Camera Dimensions	21
6.2.	Optical Axis Accuracy	22
7.	Case for Indemnity (Limited Warranty)	23
7.1.	Product Warranty	23
7.2.	CMOS Defective Pixels	23
7.3.	Product Support	23

1. Handling Precautions

1.1. Camera Handling Precautions

- Do not use or store camera in dusty or humid places.
- Do not apply excessive force, vibration, or static electricity that could damage camera. Please handle camera with care.
- Do not shoot direct images that are extremely bright (e.g., strong light source, sun, etc.). When extremely strong light source is shot, smear or blooming may occur. Put the lens cap on when camera is not in use.
- Follow the instructions in [Chapter 3.3., "External Connector"](#) for connecting camera. Improper connection may cause damages not only to the camera but also to the connected devices.
- Confirm mutual ground potential carefully before connecting camera to monitors or computers. Any AC leak from the connected devices may cause damages or destroy the camera.
- Do not apply excessive voltage. (Use only the specified voltage.) Unstable or improper power supply voltage may cause damages or malfunction of the camera.
- Voltage ripple of camera power DC+10.8V~26.4V must be within $\pm 50\text{mV}$. Improper power supply voltage may cause noises on video signals.
- Rise time of camera power supply voltage must be less than +10V, Max. 60ms. Please avoid noises like chattering.
- Our warranty does not apply to damages or defects caused by irregular and/or abnormal use of the product.

Our warranty does not apply to damages or defects caused by neglecting the instructions and precautions explained in this manual.

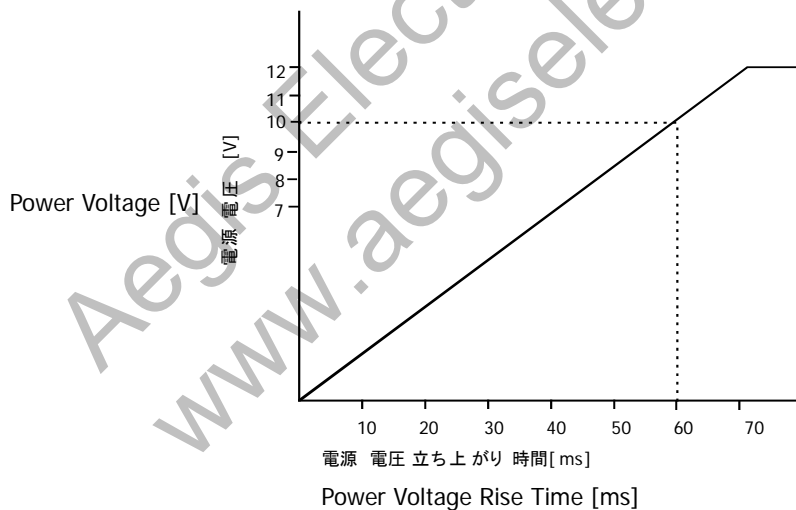

1.2. Restrictions on Applications

- The camera must not be used for any nuclear equipment or aerospace equipment with which mechanical failure or malfunction could result in serious bodily injury or loss of human life.
- The camera must not be used under conditions or environments other than those specified in this manual.

1.3. Disclaimers (Exception Clause)

CIS should not be liable for any damages or losses if;

- damages or losses are caused by earthquake, lightning strike, fire, flood, or other acts of God.
- damages or losses are caused by deliberate or accidental misuse by user, or failure to observe information and instructions explained in this manual.
- damages or losses are caused by repair or modification conducted by user or any unauthorized party.

2. Product Outline

VCC-120CXP1M is a high resolution, B/W camera with CoaXPress interface. Compact in size, 65mm (H) x 65mm (W) x 68mm (D) with 120M pixels resolution. Complies with CoaXPress Version 1.1.1 and transfers data up to 100m with CXP-3 and 40m with CXP-6. Must have function ready for Machine Vision applications such as trigger shutter, ROI, Gain, shading correction, black level adjustment, noise filter function, and strobe-pulse control function. Suitable for various Machine Vision inspection systems, medical imaging, and life science imaging systems.

2.1. Features

- Rolling shutter type CMOS sensor
- Complies with CoaXPress CXP-3 and CXP-6
- Supports 4 lanes or 2 Lanes
- Supports PoCXP
- Maximum cable length: Approx. 40m with CXP-6 / Approx. 100m with CXP-3
- ROI function
- Exposure setting, Gain setting
- External trigger mode (Fixed trigger shutter mode)
- Complies to GenICam
- M48 lens mount

2.2. Accessories

- Standard accessory
 - Lens cap
- Optional accessory
 - M48 to F lens mount conversion adaptor

3. Specifications

3.1. General Specifications

Electrical Specifications		
Image sensor	Sensor type	APS-H, rolling shutter type CMOS sensor
	Effective pixels	13264 (H) × 9180 (V)
	Unit cell size	2.2μm (H) × 2.2μm (V)
Interface		Complies with CoaXPress Ver. 1.1.1., CXP6 / CXP3
Video output frequency	Pixel clock frequency	1152MHz
Video output format		Mono 8 / Mono 10
Frame rate	CXP6_X4 8bit/10bit	9.39fps / 9.39fps
	CXP6_X2 8bit	9.39fps
	CXP3_X4 8bit	9.39fps
Resolution		13264 (H) × 9180 (V)
Video signals	White clip level	FFh with MONO8
	Set up level	0h with MONO8, with factory setting
	Dark shading	0~1h(H), 0~1h(V) with MONO8, with factory setting
Sensitivity		F4.0 400lx (Shutter speed 1/30s, Gain 0dB)
Minimum illumination		F2.6 3.5lx (Gain +18dB, Shutter speed 1/30, level=50%)
Gain variable range		x1 ~ x8 (0dB~18dB)
Shutter speed		Preset : 1/20000, 1/10000, 1/5000, 1/2000, 1/1000, 1/500, 1/200, 1/100, 1/60, 1/50, 1/30, 1/10 [s] Manual : 46 [μs] ~ 4999996 [μs]
Gamma correction		None (γ=1)
Trigger mode		Free run mode (Camera internal trigger) Trigger mode (Host, external terminal)
Partial scan		Preset ROI: 3 patterns (8192x4096, 3840x2160, 1920x1080) Custom ROI: X (640~13264), Y (480~9180)
Power requirements		12pins circular connector (12~24V) or PoCXP
Power consumption		7.0W (CXP6_X4), [with free run]

Mechanical Specifications	
Dimensions	H: 65mm W: 65mm D: 68mm excluding projection.
Weight	Approx. 300g
Lens Mount	M48 mount

Environmental Specifications		
Safety/Quality Standards		UL: Complies with UL Standard including materials.
		CE: Emission: EN61000-6-4:2007+A1:2011 Immunity: EN61000-6-2:2005
		RoHS: Complies with RoHS2.
Durability	Vibration	Acceleration : 98m/s ² (10G)
		Frequency : 20 ~ 200Hz
		Direction : X,Y, and Z 3 directions
		Testing time : 120min each
	Shock	No malfunction with 980m/s ² (100) G for ±X, ±Y, and ±Z, 6 directions without packaging.
Operational temperature		0 ~ +45°C Humidity: 20~80% RH with no condensation
Storage temperature		-25 ~ +60°C Humidity: 20~80% RH with no condensation

3.2. Input and Output Specifications

3.2.1 Trigger Input (12pins circular connector, No.11 pin)

- 5.0V, 3.3V CMOS level / TTL level
- Input voltage Low: 0.5Vdc (Max), High: 2.1Vdc (Min)
- To use this terminal, set Trigger Source of AcquisitionControl to Line 0.

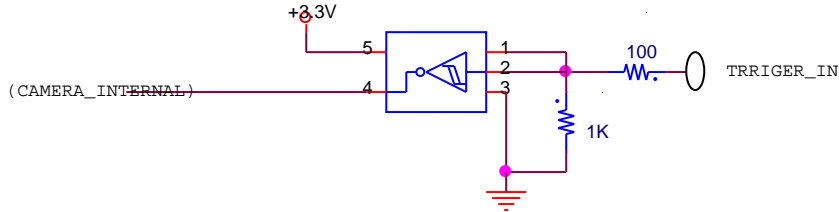

3.2.2 Exposure/Strobe Output (12pins circular connector, No.9 pin)

- 5.0V CMOS logic level output
- Output voltage Low: 0.55Vdc (Max), High: 3.8Vdc (Min)

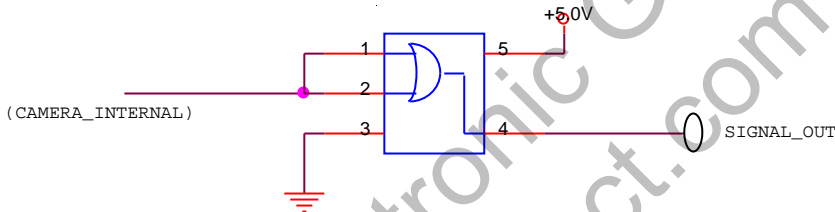

3.2.3 FVALL_OUT/LVAL_OUT (12pins circular connector No. 6, 7, and 10 pin)

- 5.0V CMOS logic level output
- Output voltage Low: 0.55Vdc (Max), High: 3.8Vdc (Min)

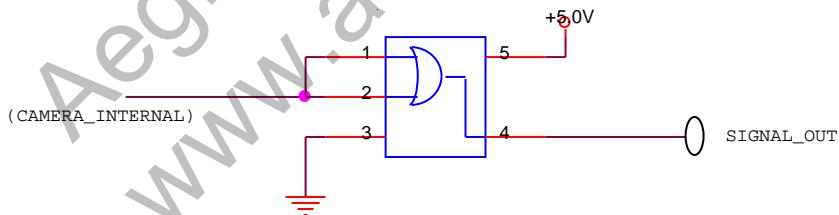

3.3. External Connector Pin Assignment

3.3.1 12pins Circular Connector HR10-10R-12PA (73) (HIROSE) or Equivalent

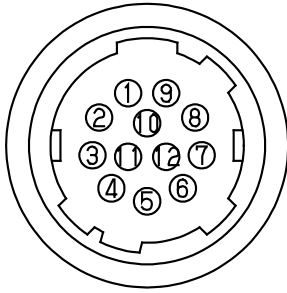

Pin No.	Signals	Description
1	GND	GND
2	Power	External power input
3	NC	
4	NC	
5	GND	GND
6	LVAL_OUT	Line read out signals output
7	FVAL_OUT	Frame read out signals output
8	GND	GND
9	STRB_OUT	Exposure, Sensor timing signals output
10	LinkTrigger_OUT	External trigger signals output from Host Device (LinkTrigger0)
11	TRIGGER_IN	External trigger input (Line0)
12	GND	GND

※NC=Non-Connection. Do not connect anything to the terminal.

※LinkTrigger_OUT signal is to monitor the external trigger signals from Host Device.

3.3.2 75Ω DIN Connector (Quad type/Dual type)

- CoaXPRESS Video output signals.
- No. 1 pin is for PoCXP.
- With dual type, connect cables to No. 1 pin and No. 2 pin.

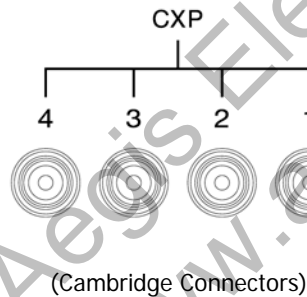

3.3.3 LED Indicator

With LED indicator ON, lighting patterns show the camera status by its way of lighting.

OFF	No power supply.
Green/Orange Fast Blinking [12.5Hz]	Disconnection of 4 cable lines.
Green Lighting	Completion of connection between device and host.
Green Fast Blinking [12.5Hz]	Transmitting video data.
Orange Slow Blinking [1Hz]	Waiting for a trigger input.
Red Slow Blinking [0.5Hz]	Image transmission error or inappropriate trigger input.

3.4. Spectral Response

※ Excludes characteristics of lens, IR cut filter, and light source.

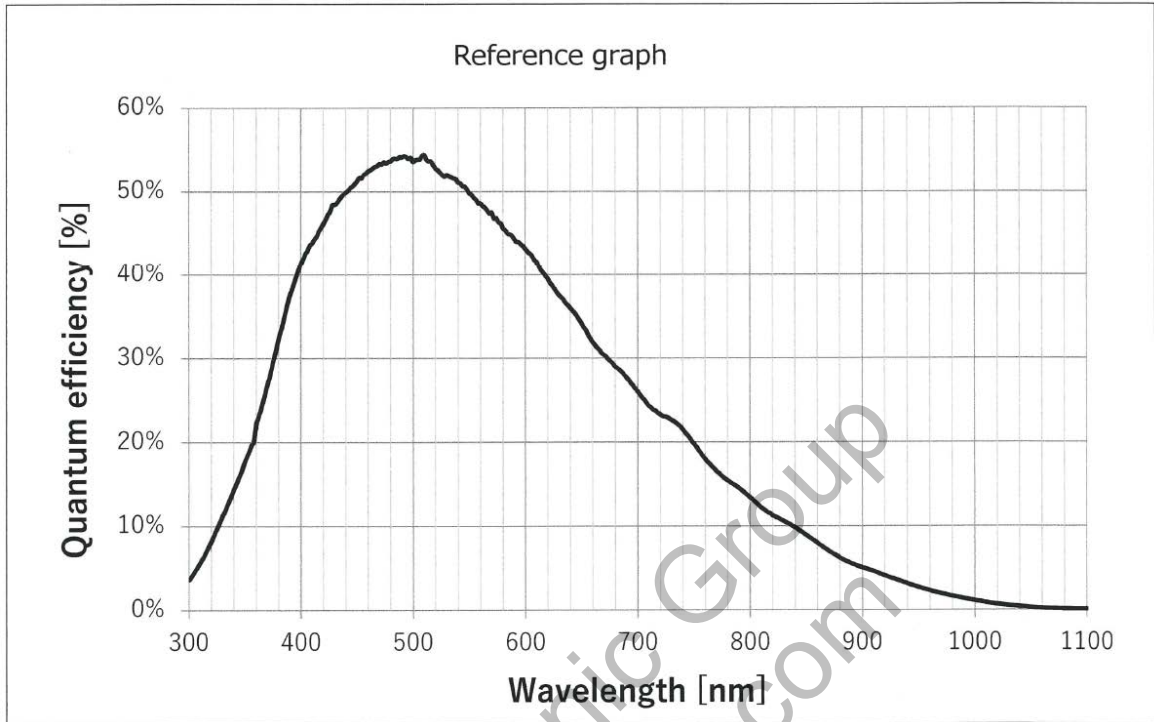

Aegis Electronic Group
www.aegiselect.com

4. Camera Functions

4.1. Camera Interface

- ◆ Complies with CoaXPress interface standard.

4.2. Camera Information

- Indication of camera information.

DeviceControl	
DeviceModelName	ReadOnly
DeviceVersion	ReadOnly
DeviceFirmwareVersion	ReadOnly
DeviceSerialNumber	ReadOnly

- DeviceModelName : Model name of the camera
- DeviceVersion : Circuit Version
- DeviceFirmwareVersion : Firmware Version
- DeviceSerialNumber : Serial number of the camera

- Set a letter string as user ID with up to 16 characters including terminal NUL letter (\0). Execute "UserSetSave" to save the letter string to volatile memory in the camera. Execute "UserSetDefault" to restore to factory setting.

DeviceControl	
DeviceUserID	Manual

4.3. LED Operational Mode

- This is to change operational mode of LED at the rear of camera. For information on lighting patterns, refer to Section 3.3.3. LED Indicator.

DeviceControl	
DeviceIndicatorMode	Active ErrorStatus Inactive

- Active : Indication of communication status of CoaXPress
- ErrorStatus : OFF with normal operation.
Lights only with video transmission error or inappropriate trigger input.
- Inactive : ALL LED OFF

4.4. Partial Scan (ROI)

- This is to increase frame rate by cutting and reducing read out area.

ImageFormatControl	
Width	640~13264
Height	480~9180
OffsetX	Manual
OffsetY	Manual
ROIQuickChange*	Execute

- Preset ROI

- Execute "ROIQuickChange (X size) x (Y size)" to update "Width", "Height", "OffsetX", and "OffsetY".
- Execute "ROIQuickChange (X size) x (Y size)" to proceed center ROI.
- Execute "ROIQuickChangeOff" to restore to full size 13264 x 9180.
- Please refer to the chart below for details on frame rate.

※ Note) Exposure time overrides when shutter speed setting is longer than frame rate setting.

Preset ROI frame rate [fps]

ROI Setting Mode (WidthxHeight,OffsetX,OffsetY)	Known as	PixelFormat	Link rate		
			CXP6_X4	CXP6_X2	CXP3_X4
ROIQuickChangeOff (13264x9180,0,0)	120M	mono8	9.39	9.39	9.39
		mono10	9.39	-	-
ROIQuickChange8192x4096 (8192x4096,2536,2542)	8K	mono8	20.94	20.94	20.94
		mono10	20.94	-	-
ROIQuickChange3840x2160 (3840x2160,4712,3510)	4K	mono8	39.41	39.41	39.41
		mono10	39.41	-	-
ROIQuickChange1920x1080 (1920x1080,5672,4050)	Full HD	mono8	77.54	77.54	77.54
		mono10	77.54	-	-

- Custom ROI

- With Width, specify the size of ROI for X direction per 16 pixels. (640 is the minimum).
Note) Some grabber boards takes only multiple of 32 pixels. In such case, use multiple of 32.
- With Height, specify the size of ROI for Y direction per 2 pixels. (480 is the minimum).
- With OffsetX, specify offset of ROI for X direction from left per 8 pixels.
- With OffsetY, specify offset of ROI for Y direction from top per 2 pixels.
- OffsetX and OffsetY must meet the following conditions.

$$\text{OffsetX} + \text{Width} \leq 13264, \text{OffsetY} + \text{Height} \leq 9180$$

- According to set height, the formula below calculates frame rate. This calculated frame rate limits frame rate of custom ROI.
- Note) Exposure time overrides when shutter speed setting is longer than frame rate setting.

$$\text{Formula for frame rate: } (\text{Height} + 38) * 11.53\mu\text{s}$$

4.5. Pixel Format

ImageFormatControl	
PixelFormat	Mono8 Mono10

- Mono8 : Mono 8bit
- Mono10 : Mono 10bit

4.6. Cursor Indication

- This is to show cursor on your display screen.

ImageFormatControl	
ShowCursor	On/Off
CursorX	X coordinate
CursorY	Y coordinate
CursorColor	White/Black

- ShowCursor : Cursor indication On/Off.
- CursorX : To specify X coordinate of vertical cursor.
- CursorY : To specify Y coordinate of horizontal cursor.
- CursorColor : To select the color of cursor (black or white).

[Note]

- With reduced display screen, cursor may not appear.
- Displaying cursor and test pattern are mutually exclusive.

4.7. Test Pattern Indication

- This is to display test pattern from camera. This is useful to check if your system is operating properly.

ImageFormatControl	
TestPattern	ON/OFF

[Note] Displaying test pattern and cursor are mutually exclusive.



4.8. Trigger Mode

Acquisition Control	
TriggerSelector	AcquisitionStart FrameStart Off
TriggerActivation	RisingEdge FallingEdge
TriggerSource	LinkTrigger0 Line0
TriggerSoftware	Execute

- TriggerSelector

This is to select how to start capturing video out of the followings.

- AcquisitionStart : Free run mode [Internal sync. mode]
- FrameStart : Trigger mode [External sync. mode]
- Off : Stop operation

- TriggerActivation

This is to select trigger polarity out of the followings.

Valid when TriggerSelector mode is FrameStart.

- RisingEdge : Rising edge [External sync mode]
- FallingEdge : Falling edge [External sync mode]

- TriggerSource

This is to select where to send external trigger.

- LinkTrigger0 : External trigger input from CoaXPress Host Device.
Please refer to specification manuals of Host Device such as frame grabber board to know how to generate triggers.
- Line0 : External trigger input from 12pins circular connector.

- TriggerSoftware: Software trigger

Camera generates a trigger to capture one frame image by executing this command.

Valid when TriggerSelector mode is FrameStart.

※Please set TriggerActivation to RisingEdge.

4.8.1 Internal Sync Mode (Free Run Mode)

- With this mode, camera continuously outputs images.
- Set TriggerSelector to AcquisitionStart.

With Standard Exposure

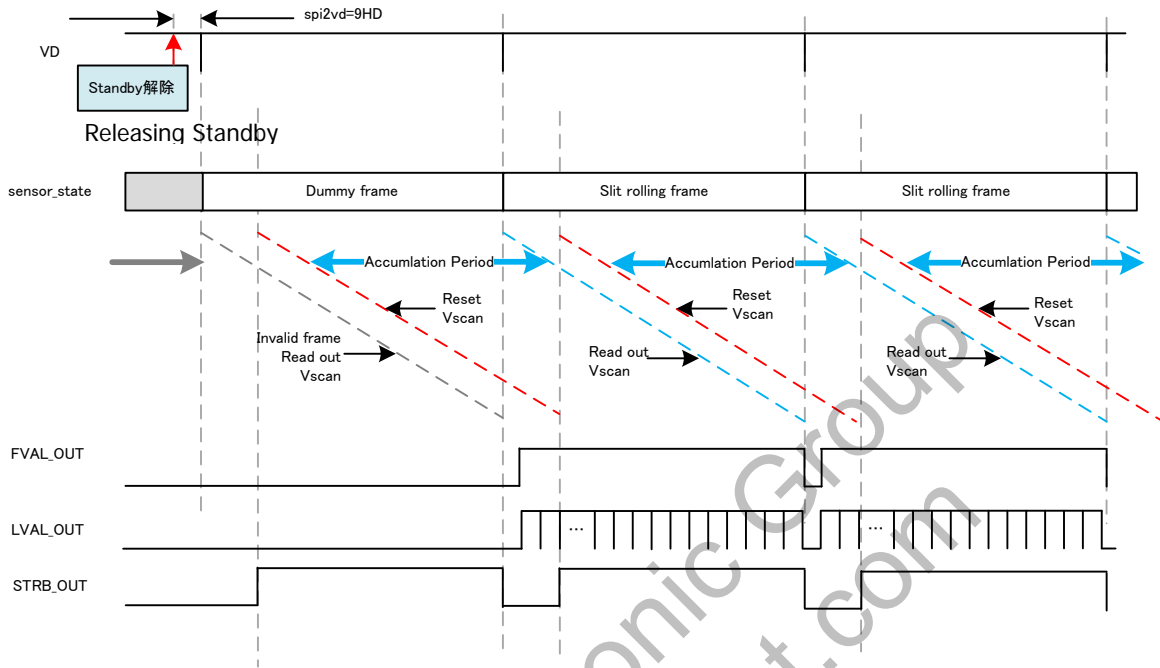

With Long Time Exposure (Exposure time is longer than 1 frame)

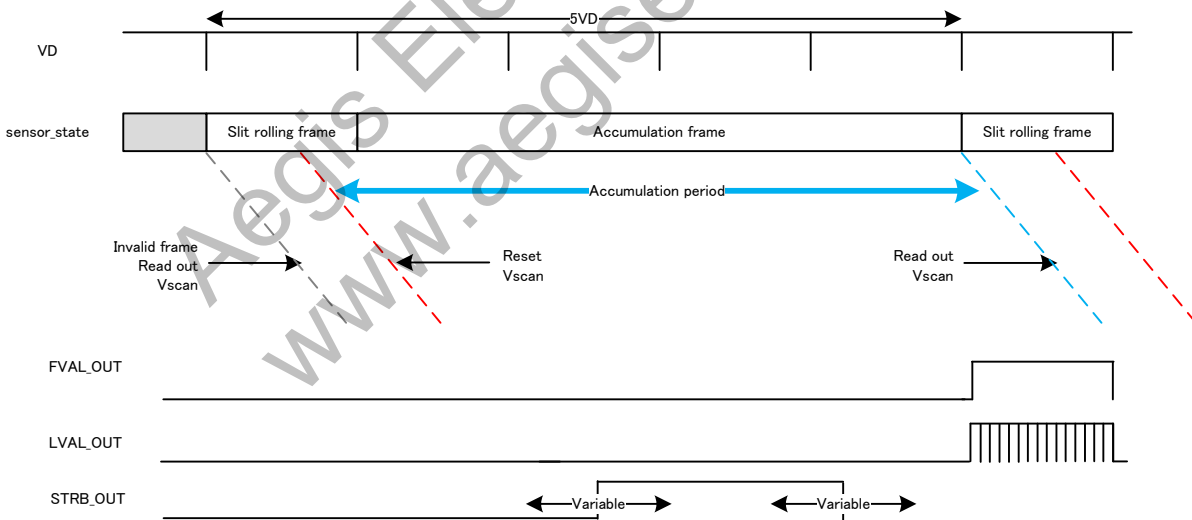

※ When exposure time is 4.5 frames, frame cycle rounds up to 5 frames.

4.8.2 External Sync Mode

- This is a mode to capture images with preferred timings by inputting external trigger signals.
- Set "TriggerSelector" to "FrameStart".
- With a trigger signal input, camera exposes for a period set by "ExposureTime".
- Set "TriggerActivation" to "RisingEdge" or "FallingEdge".
- Trigger cycle must be longer than (frame for exposure time +1).
 - ※Round up fraction to the nearest whole number to calculate. (Ex. When exposure time is 1.5 frames, trigger cycle becomes 2+1= 3 frames).
- Trigger operation is CLK sync H-V Sync reset.
- Trigger pulse width to input must be from 30us to the maximum exposure time.
- Maximum exposure time depends on ROI setting, "PixelFormat", and link rate. Please refer to Section [4.10. Exposure Time](#) for details.
- Due to physical characteristics of image sensor, there are some delays between the actual exposure start and trigger input designated by shutter speed setting (Rest Vscan). With higher shutter speed settings, time from trigger input to actual exposure start takes longer.

With Standard Exposure

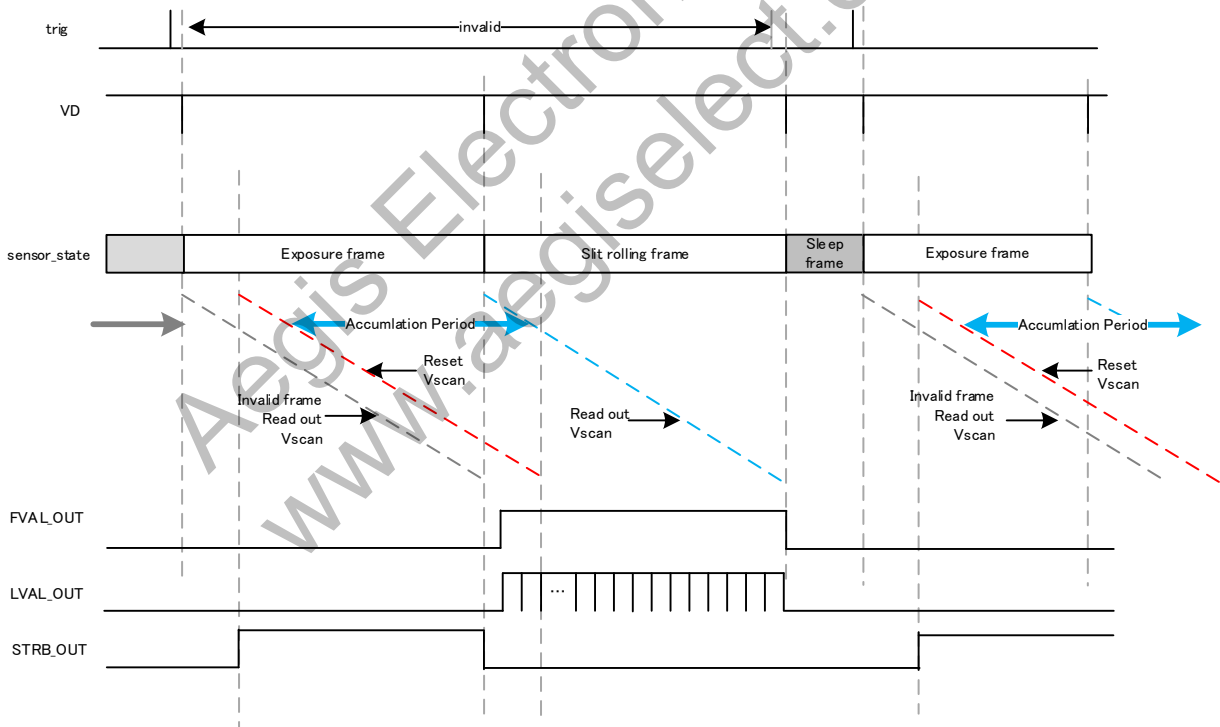

※ Frame cycle becomes two frames more than standard exposure with internal sync mode.

With Long Time Exposure (Exposure time is longer than 1 frame)

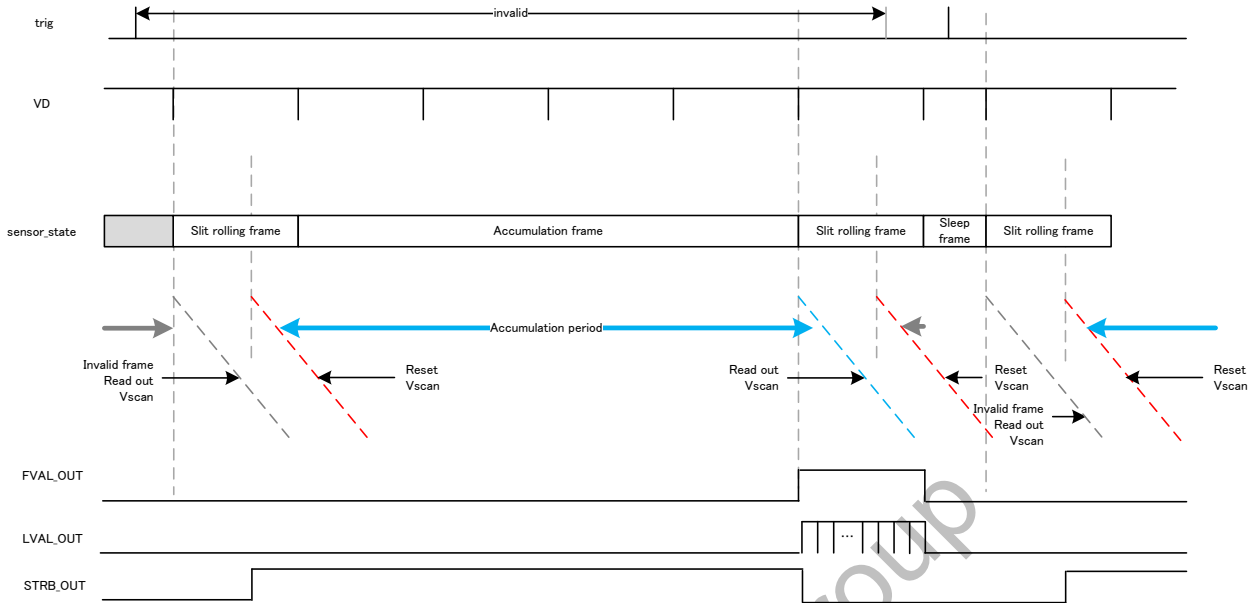

※ When exposure time is 4.5 frames, exposure time rounds up. Frame cycle becomes 6 frames more than standard exposure with internal sync mode.

Aegis Electronic Group
www.aegiselect.com

4.9. Strobe Pulse Control

- This is to output timing signals for exposure or reading out.
 - Wide Strobe This is to output signals from the start of exposure to the completion of reading out sensor. Valid only with external trigger. (Always assert with free run (overlapping operation)).
 - Narrow Strobe This is to output signals during exposure of entire lines of image sensor. Valid only with long time exposure (Exposure time is longer than one frame). (Always negate with standard exposure).
 - Manual Strobe This is to set rising edge and falling edge of signals with preferred timings.
 - No Strobe This is to stop outputting signals.

Acquisition Control	
StrobeSelector	Wide Strobe Narrow Strobe Manual Strobe No Strobe
StrobeActivation	Positive Negative
StrobeDelay	Specify delay time between trigger input to strobe pulse with μs . Set delay time with multiples of 11.5 μs . ※ With other than multiples of 11.5 μs , the nearest value will be set. Note) With a line number more than that of trigger cycle, abnormal operation will occur.
StrobeWidth	Specify strobe pulse width with μs . Set pulse width with multiples of 11.5 μs . ※ With other than multiples of 11.5 μs , the nearest value will be set. Note) With a line number more than that of trigger cycle, abnormal operation will occur. Note) With free run mode, operation becomes overlapping. Therefore, strobe pulse always assert if strobe width setting is more than exposure period.

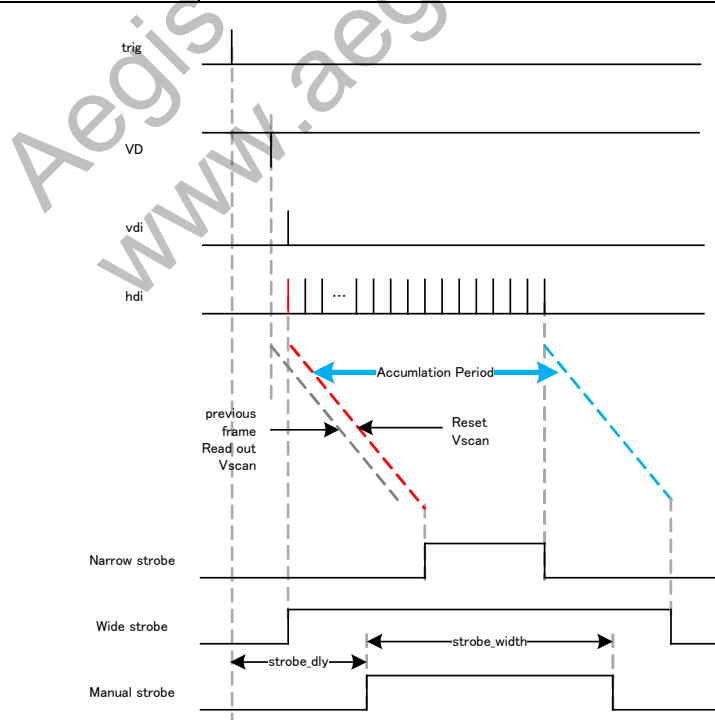

4.10. Exposure Time

Acquisition Control	
ExposureTime (us)	Manual
ExposureTimeMax	ReadOnly

- ExposureTime

Set with multiples of 11.5us.

※When setting is other than multiples of 11.5us, the nearest value will be set.

When exposure time setting is longer than frame rate, frame rate becomes longer (Exposure time takes priority).

※When exposure time is 1.5 frames, frame rate rounds up and frame cycle becomes 2 frames.

The maximum exposure time is 5 sec.

- PresetShutter1_Xs : Preset Shutter Value

Set a preset shutter value to reflect it to exposure time setting.

PresetShutter1_Xs	Shutter (s)	Exposure time (μs)
Shutter_1_30s	1/30	33337 us
Shutter_1_50s	1/50	20002 us
Shutter_1_60s	1/60	16663 us
Shutter_1_100s	1/100	9995 us
Shutter_1_200s	1/200	5003 us
Shutter_1_500s	1/500	1999 us
Shutter_1_1000s	1/1000	1005 us
Shutter_1_2000s	1/2000	496 us
Shutter_1_5000s	1/5000	196 us
Shutter_1_10000s	1/10000	104 us
Shutter_1_30000s	1/20000	46 us

4.11. Gain

AnalogControl	
Gain	Manual
PresetGainX	Execute

- Gain : x1 to x8 preferred gain settings per 0.125.

[Note]

Gain setting range is up to +8 times. However, with high gain settings, noise will increase.

- PresetGainX : Preset gain

Set preset gain values to reflect them to manual gain. Function does not reflect manual gain values to preset gain. Preset values are not subject to save.

PresetGainX	Magnification	Decibel equivalent
Gain_x1	x1	0dB
Gain_x2	x2	6.0dB
Gain_x3	x3	9.5dB
Gain_x4	x4	12.0dB
Gain_x5	x5	14.0dB
Gain_x6	x6	15.6dB
Gain_x7	x7	16.9dB
Gain_x8	x8	18.0dB

4.12. Black Level Adjustment

- This is to adjust black level.

AnalogControl	
BlackLevel	0~15

BlackLevel	8bit	10bit
0	0	0
1	4	17
2	8	34
3	12	51
4	17	68
5	21	85
6	25	102
7	29	119
8	34	136
9	38	153
10	42	170
11	46	187
12	51	204
13	55	221
14	59	238
15	63	255

※ This function is valid only for + direction.

4.13. Shading Correction

- This is to correct the drop in the amount of peripheral light caused by lens and others.

AnalogControl	
ShadingCorrection	On/Off
DetectShading	Execute

- ShadingCorrection

Turn ShadingCorrection "ON" to start shading correction according to correction data prepared by shading detection.

Before shading correction

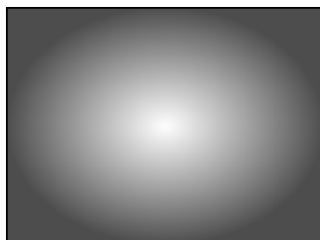

After shading correction



- DetectShading : Shading Detection

Shoot an object with stable brightness such as pattern box, to full screen. Execute DetectShading to automatically calculate correction data.

[Note]

- Make sure to turn OFF partial scan mode (ROI) to detect shading. Set image size to 13264 x 9180 to execute.
- Acquire correction data only when camera is in operation. Acquisition of shading correction data is invalid when there is no output from camera.
- Execute UserSetSave to save the correction data.
- When obtain correction data with trigger shutter mode, the data sometimes becomes unstable. In this case, change the trigger cycle in small measure and obtain correction data again.

4.14. Defective Pixel Correction

- Defective pixel correction registered at factory.
CIS compensates noticeable CMOS pixel defects found upon shipment from our factory.
User can disable this function.

AnalogControl	
DefectivePixelCorrection	On/Off
DefectPixelTotalNumber	0~70000
DefectPixelNumber	1~70000
DefectPixelOffsetX	0~13263
DefectPixelOffsetY	0~9179

- DefectivePixelCorrection : Turn this ON to correct defective pixels up to the 8192th pixel registered and shown with DefectPixelNumber.
- DefectPixelTotalNumber : Total number of defective pixels registered.
- DefectPixelNumber : This is to specify the number of the registered defective pixel.
- DefectPixelOffsetX : This is to indicate the X coordinate of the defective pixel specified with DefectPixelNumber.
- DefectivePixelOffsetY : This is to indicate the Y coordinate of the defective pixel specified with DefectPixelNumber.

[Note]

- Perfect correction of defective pixels is not possible.

4.15. Noise Filter

- This is a function to correct defective pixels in real time.

AnalogControl	
ImpulseNoiseFilter	Off VariableByGainMode FixedValueMode
ImpulseNoiseFilterThreshold	0~1023

- ImpulseNoiseFilter
Invalid with OFF.
With VariableByGainMode, value of ImpulseNoiseFilterThreshold changes corresponding to gain settings (in the range of x1~x8) and this function executes defective pixel correction with camera internal set value.
With FixedValueMode, this function executes defective pixel correction with value set by ImpulseNoiseFilterThreshold.
With OFF or VariableByGainMode, user cannot change the value of ImpulseNoiseFilterThreshold.
With FixedValueMode, user can change the value of ImpulseNoiseFilterThreshold.
※Excessive correction may cause negative effects on images.

- ImpulseNoiseFilterThreshold

Threshold setting between defective pixels and peripheral pixels.

When value exceeds the threshold with plus and minus, function corrects defective pixels using peripheral pixels.

※When threshold setting is 1023, defective pixel correction becomes invalid.

※Check images to adjust threshold.

4.16. Link Speed and Link Count

Transfer Control	
ConnectionConfig	CXP3_X4
	CXP6_X2
	CXP6_X4

- CXP3_X4 : Link speed=3.125Gbps, Link count=4

- CXP6_X2 : Link speed=6.250Gbps, Link count=2

- CXP6_X4 : Link speed=6.250Gbps, Link count=4

4.17. How to Save and Initialize Settings

- Execute "UserSetSave" to save settings into camera non-volatile memory. Camera initializes with saved settings upon next rebooting.

UserSets	
UserSetSave	Execute
UserSetDefault	Execute

- UserSetSave : This is to save camera-setting values.

- UserSetDefault : This is to restore camera settings to factory settings.

- Set ConnectionConfig to "CXP3_X4" to execute "UserSetDefault".
- Immediately after completion of UserSetDefault, camera settings will be restored to factory settings. However, in some cases, command indication remains as previous settings. Please make sure to update commands.

5. Factory Settings

Function	Data	Descriptions
DeviceUserID	DeviceUserID	
DeviceIndicatorMode	Active	
Width	13264	
Height	9180	
OffsetX	0	
OffsetY	0	
PixelFormat	Mono8	
ShowCursor	Off	
CursorX	6632	
CursorY	4590	
CursorColor	White	
TestPattern	Off	
TriggerSelector	AcquisitionStart	
TriggerSource	LinkTrigger0	
ExposureTime	33337.000	
StrobeSelector	NoStrobe	
StrobeActivation	Positive	
StrobeDelay	0	
StrobeWidth	0	
Gain	1.000	
BlackLevel	0	
ShadingCorrection	Off	
DefectivePixelCorrection	On	
ImpulseNoiseFilter	Off	
ConnectionConfig	CXP3_X4	

※ Factory settings are the same as UserSetDefault command.

6. Dimensions
6.1. Camera Dimensions

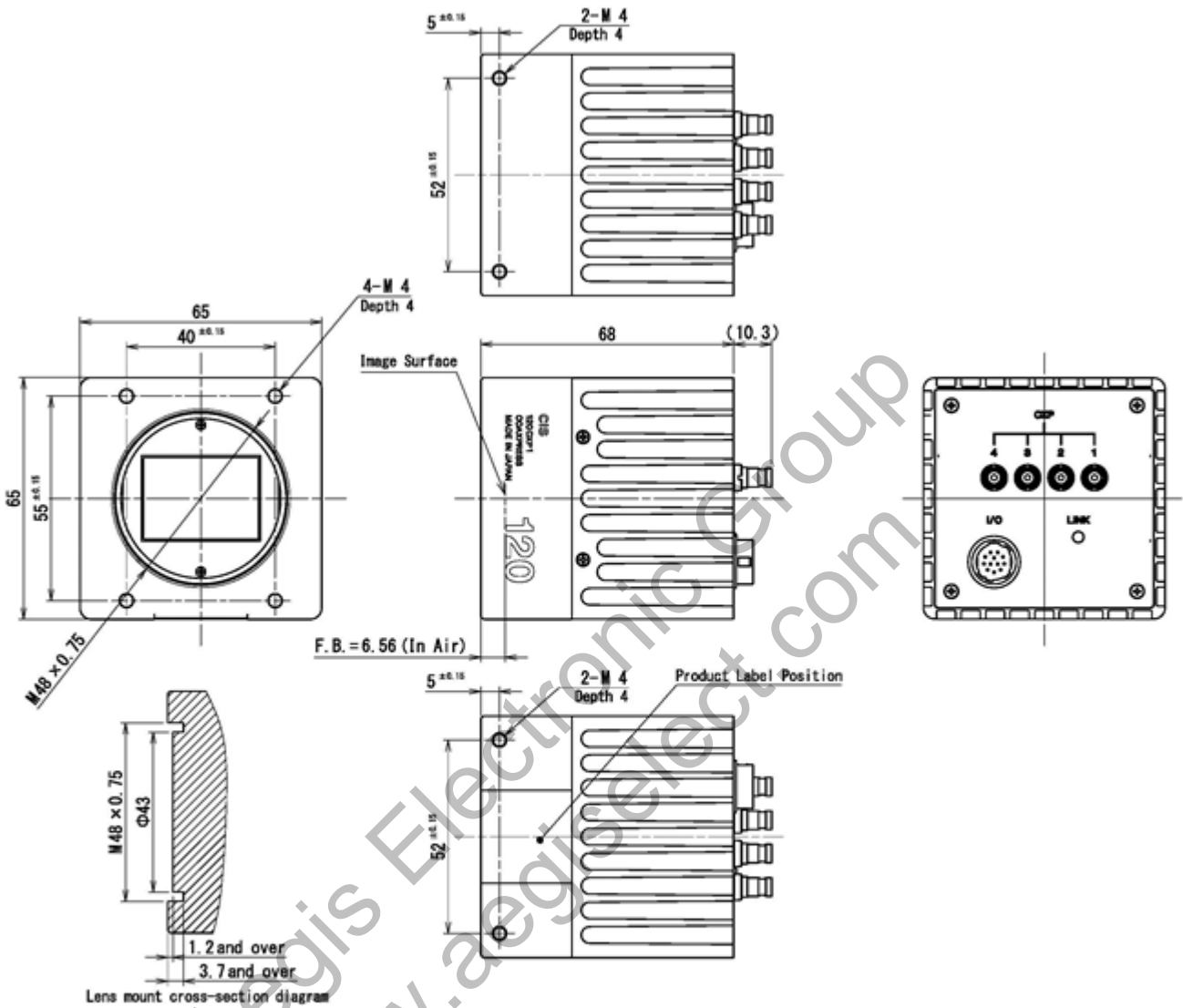

Note 2) Lens mount screw complies with M48x0.75-6H. Please refer to J11A LE-004-2011.
 Note 1) Please make sure the protrusion portion does not interfere with the lens selected.
 Refer to the lens mount cross-section diagram for the details.

935-0076-00
(Unit:mm)

6.2. Optical Axis Accuracy

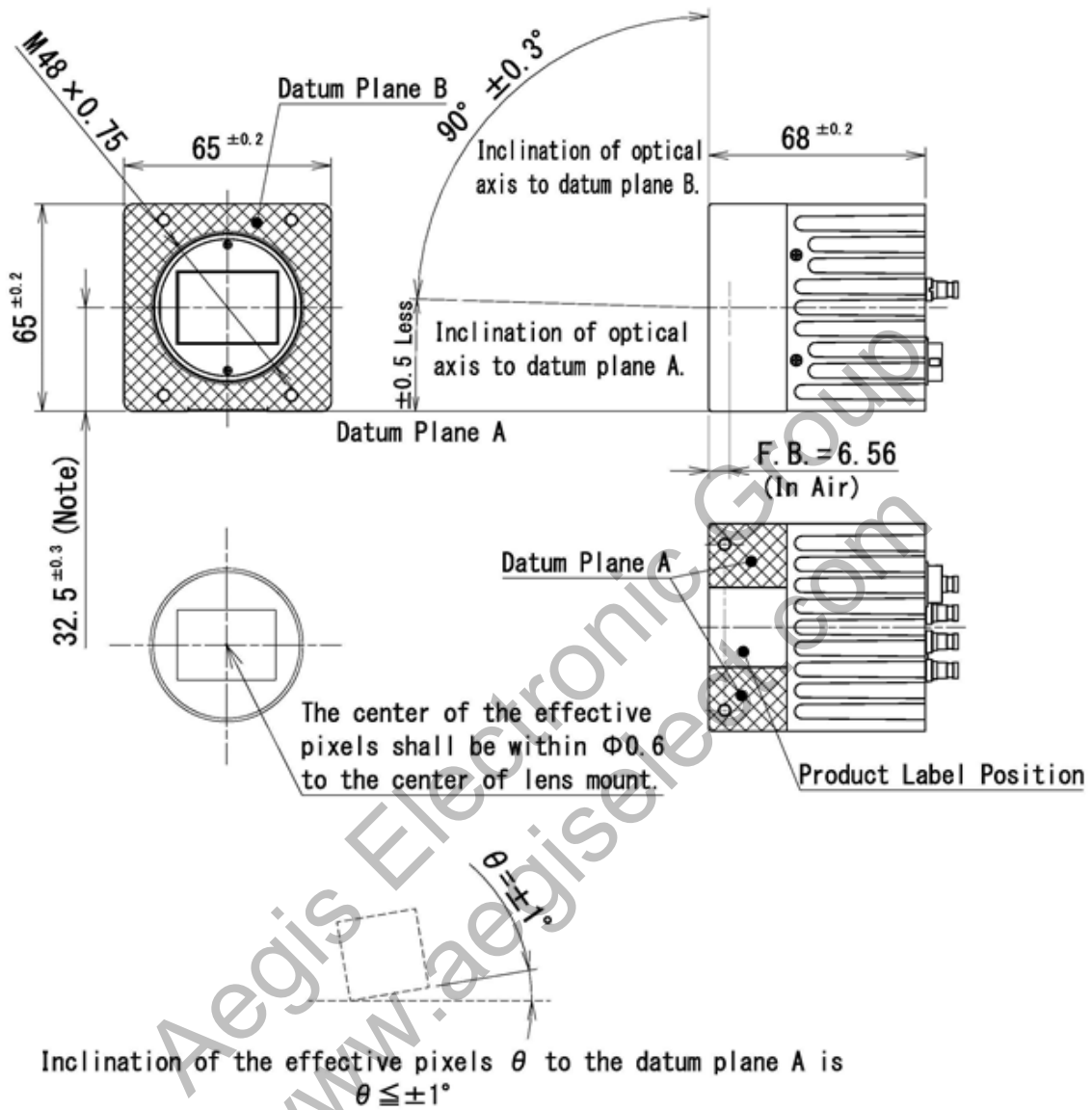

Note : Dimensions from datum plane A to the center of the lens mount.

937-0018-00
(Unit : mm)

7. Case for Indemnity (Limited Warranty)

7.1. Product Warranty

The term of warranty of this product is within 3 years from the date of shipping out from our factory.

If you use the product properly and discover a defect during the warranty period, and if that was caused by designing or manufacturing, CIS Corporation, at its option, repairs or replaces it at no charge to you. Products out of warranty period will be subject to charge.

CIS should not hold responsible for damages or losses if;

- damages or losses are caused by earthquake, lightning strike, fire, flood or other acts of God.
- damages or losses are caused by deliberate or accidental misuse by user, or failure to observe the information contained in the instructions in this Product Specification and Operational Manual.
- damages or losses are caused by repair or modification conducted by customer or any unauthorized party.

7.2. CMOS Defective Pixels

CIS applies defective pixel correction prior to the shipment of the product. However, the number of defective pixels are subject to increase due primarily to the effect of cosmic rays. Due to this nature, CIS should not hold responsible for the natural increase of defective pixels.

7.3. Product Support

Should you have any problems in function of the product you purchased, and if you need our further analysis and/or repair, please contact your local distributor.

Aegis Electronic Group
www.aegiselect.com