

CIS

Camera Link I/F
25M pixels CMOS (RAW) Camera

VCC-25CL1R

Product Specifications & Operational Manual

CIS Corporation

Table of Contents

1.	Handling Precautions	3
1.1.	Camera Handling Precautions.....	3
1.2.	Restrictions on Applications.....	3
1.3.	Disclaimers (Exception Clause)	4
2.	Product Outline	4
2.1.	Features.....	4
2.2.	Bundled Items	4
3.	Specifications.....	5
3.1.	General Specifications.....	5
3.2.	Camera Input and Output Signals Specifications	7
3.2.1	12pins Circular Connector No. 11 pin: Trigger Input	7
3.2.2	12pins Circular Connector No. 6, 7, 9, and 10 pin : LVAL, FVAL, Exposure, and DVAL output.....	7
3.3.	External Connector Pin Assignment.....	7
3.3.1	12 pins Circular Connector HR10-10R-12PA(73) (HIROSE) or equivalent	7
3.3.2	Camera Link Connector 12226-1100-00PL (SUMITOMO 3M).....	8
3.3.3	PoCL/CL Selection Switch.....	8
3.3.4	LED Indicator (DC IN)	9
3.4.	CMOS Spectral Response	9
3.5.	Video Output Format	10
3.6.	Timing Chart	11
3.6.1	Horizontal Synchronous Signals Timing (8Tap Full Configuration mode: 21.54fps/24.95fps) Factory Setting.....	11
3.6.2	Horizontal Synchronous Signals Timing (10Tap 8bit Configuration mode : 31.96fps)	11
3.6.3	Vertical Synchronous Signals Timing	12
4.	Camera Operational Specifications	13
4.1.	Camera Operational Mode.....	13
4.1.1	Custom ROI Mode (Region of Interest)	13
4.1.2	Multiple ROI Mode	14
4.1.3	Sequence Control Mode.....	15
4.1.3.1	Sequence Control Burst Mode Operational Outline	16
4.1.3.2	Sequence Control Step Mode 1 Operational Outline.....	18
4.1.3.3	Sequence Control Step Mode 2 Operational Outline.....	20
4.1.3.4	Image Output of Sequence Status	22
4.2.	Gain Settings	23
4.3.	Settings of Exposure Time	24
4.4.	Trigger Mode	25
4.4.1	Fixed Trigger Shutter Mode	25
4.4.2	Pulse Width Trigger Shutter Mode.....	26
4.4.3	Camera Operation when inappropriate trigger is input.....	27
4.5.	White Balance.....	28
4.5.1	One Push Start	28
4.6.	Shading Correction.....	29
4.6.1	Detect Shading Correction Data.....	29
4.7.	Gamma Selection	30
4.7.1	Gamma Selection	30
4.7.2	User Customizing Gamma Table	30
4.8.	Black Level Adjustment.....	31
4.9.	Test Pattern Indication.....	32
4.10.	Black Out Function.....	32
4.11.	Cursor Indication	32
4.12.	Temperature Indication.....	32

4.13.	Defective Pixels Correction Function.....	33
4.14.	User Data Save / Read Out Function	36
4.14.1.	User Data Save	36
4.14.2.	Users Data Read Out	36
5.	Remote Communication Function.....	37
5.1.	Serial Communication.....	37
5.2.	Function Settings	39
5.2.1	The List of Preset Shutter	43
5.2.2	Functions Unable to Set at the Same Time	43
6.	Dimensions.....	44
6.1.	Camera Dimensions.....	44
6.2.	Optical Axis Accuracy.....	45
7.	Case for Indemnity (Limited Warranty).....	46
7.1.	Product Warranty	46
7.2.	CMOS Pixel Defects	46
8.	Supplementary Note	46
8.1.	Product Support.....	46

Aegis Electronic Group
www.aegiselect.com

1. Handling Precautions

1.1. Camera Handling Precautions

Please observe all warnings and cautions stated below.

- Do not use or store the camera in the extremely dusty or humid places.
- Do not apply excessive force or static electricity that could damage the camera. Handle the camera with care.
- Do not shoot direct images that are extremely bright (e.g., strong light source, sun, etc.). When extremely strong light such as spot light was shot, blooming or smear may occur. Please put the lens cap on when camera is not in use.
- Follow the instructions in the [Section 3.3, "External Connector Pin Assignment"](#) for connecting the camera. Improper connection may cause damages not only to the camera but also to the connected devices.
- Confirm the mutual ground potential carefully before connecting the camera to monitors or computers. Any AC leaks or coupling noises from the connected devices may cause damages or destroy the camera.
- Do not apply excessive voltage. Use only the specified voltage. Unstable or improper power supply voltage may cause damages or malfunction of the camera.
- The voltage ripple of camera power DC $+12V \pm 10\%$ shall be within $\pm 50mV$. Improper power supply voltage may cause noises on the video signals.
- The rising time of camera power supply voltage shall be less than $+10V$, Max 60ms. Please avoid noises like chattering when rising.
- When used with one of our accessories such as repeater or control unit, please make sure to turn on camera power at the last. If not, camera malfunction may occur.
- Our warranty does not apply to damages or malfunctions caused by neglecting these precautions.

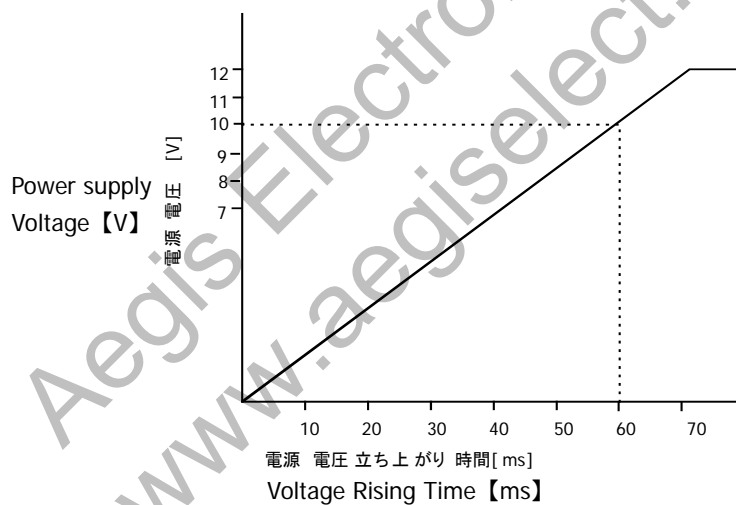

1.2. Restrictions on Applications

- The camera must not be used for any nuclear equipment or aerospace equipment with which mechanical failure or malfunction could result in serious bodily injury or loss of human life. Our warranty does not apply to damages or defects caused by irregular and/or abnormal use of the product.
- The camera must not be used under conditions or environments other than specified in this manual.

1.3. Disclaimers (Exception Clause)

CIS shall be exempted from taking responsibility and held harmless for damages or losses incurred by the following cases.

- In case damages or losses are caused by earthquake, lightning strike, fire, flood, or other acts of God.
- In case damages or losses are caused by deliberate or accidental misuse by the user, or failure to observe the information contained in the instructions in this Product Specification and Operational Manual.
- In case damages or losses are caused by repair or modification conducted by the customer or any unauthorized party.

2. Product Outline

VCC-25CL1R is a Camera Link interfaced, 25M resolution industrial camera module. APS-H type 25M pixels CMOS sensor is utilized. Entire pixels can be read out at 1/21.54s at Full Configuration output (factory setting).

2.1. Features

- Global shutter type CMOS sensor (Color).
- Camera Link Full, and Deca Configuration supported
- Exposure control, Gain settings, and White balance settings
- External trigger mode (Fixed Trigger shutter mode / Pulse width trigger shutter mode)
- Shading Correction
- Gamma Correction
- Sequence Control
- Multiple ROI
- M48 Lens mount

2.2. Bundled Items

- Camera
 - ♦ VCC-25CL1R
- Optional Item
 - ♦ M48 to F lens mount conversion adaptor
- Free Software
 - ♦ CIS control panel software for evaluation purpose only is downloadable via our web.

CIS shall be exempted from taking responsibility and held harmless for damage or malfunction of your hardware and software caused by using this control software. The purpose of this control software prepared

is for users to check operation and evaluate our products. Please be noted that CIS does not customize the program nor provide source code.

- Packaging
 - ♦ Packaging may vary depends on the quantity to be shipped.

3. Specifications

3.1. General Specifications

Electrical Specifications				
Pick up device	Device Type	APS-H type, Global shutter type CMOS		
	Effective pixel number	5120(H) x 5120(V)		
	Unit cell size	4.5 μ m(H) x 4.5 μ m(V)		
Video output mode		8Tap Full Configuration (factory setting) 10Tap 8bit Configuration		
Video output frequency	Pixel Clock frequency	Video output mode		
			8Tap 8bit Full [Factory setting]	Horizontal Frequency: 110.99kHz
	85MHz	8Tap 8bit Full		Vertical Frequency: 21.54Hz
			10Tap 8bit	Horizontal Frequency: 128.44kHz
		10Tap 8bit		Vertical Frequency: 24.95Hz
			10Tap 8bit	Horizontal Frequency: 165.02kHz
10Tap 8bit	Vertical Frequency: 31.96Hz	Scanning Lines: 5170		
	Frame rate	Pixel Clock frequency	Video output mode	
72MHz		8Tap 8bit Full	21.54fps	[Factory setting]
85MHz		8Tap 8bit Full	24.95fps	
	10Tap 8bit	31.96fps		
Sync system		Internal Sync. System		
Resolution (The maximum pixel size)		5120(H) \times 5120(V)		
Video signals (Factory setting, Environmental temperature at 25°C)	White clip level	FFh	At 8bit output	
	Set up level	02 \pm 02h	At 8bit output, and Gain 0dB	
	Dark shading	Under 04h for both horizontal and vertical.	At 8bit output, and Gain 0dB	
Sensitivity		F5.6 2000lx (Shutter speed 1/32s (OFF), Gain 0dB, [8Tap 8bit at factory setting])		
Minimum illumination		F2.6 60lx (Shutter speed 1/32s (OFF), Gain +12dB, [8Tap 8bit at factory setting])		
Gain variable range		0dB ~ +18dB		
Shutter speed		1/32s ~ 1/30000s [8Tap 8bit at factory setting]		
Trigger shutter mode		Fixed shutter trigger mode, Pulse width shutter trigger mode		
Custom ROI		Preferred settings for Start (Horizontal and Vertical) Coordinates, Horizontal effective size, and Vertical effective size can be set. Vertical: 2 ~ 5120 lines (2 lines/step) Horizontal: 64 ~ 5120 lines (64 pixels /step)		
Sequence control function		For each 8 parameter set, preferred settings for Start (Horizontal and Vertical) Coordinates, Horizontal effective size, Vertical effective size, Shutter, and Gain can be set. Control mode: Trigger mode, CC line mode, and Auto		

Electrical Specifications (Continued)			
Remote communication	115200/9600 baud selectable, data 8bit, Stop bit 1bit, No parity, Flow control XON/XOFF invalid		
Power requirements	12pins circular connector or PoCL 12pin: DC+12V±10% PoCL (factory setting): DC+12V ※Supply power from both cables.		
Power consumption	Typ 7.4W (Full Configuration, Full frame scan output) [factory setting] Max 8.0W		
Mechanical Specifications			
Dimensions	H:65mm W:65mm D:40.5mm (without protruding portion) Refer to the Section 6.1. Camera Dimensions		
Weight	Approx. 210g		
Lens mount	M48 lens mount (Mount conversion adaptor to F mount is prepared.) Refer to the Section 6.1. Camera Dimensions		
Optical axis accuracy	Refer to the Section 6.2. Optical Axis Accuracy		
Environmental Specifications			
Safety/Quality Standard	UL: Conform to UL for all materials CE: 2014/30/EU Emission: EN61000-6-4:2007+A1:2011 Immunity: EN61000-6-2:2005 RoHS: 2011/65/EU Conform to EN50581 (RoHS 2) KC: R-R-clis-VCC-25CL1M		
Durability	Vibration	Acceleration	: 98m/s ² (10G)
		Frequency	: 20 ~ 200Hz
		Direction	: X,Y, and Z 3 directions
		Testing time	: 120 min for each direction
	Shock	No malfunction shall be occurred with 980m/s ² (100G) for ±X,±Y, and ±Z, 6 directions without packaging.	
Operation Guaranteed Temperature		-5 ~ +45°C	Humidity 20 ~ 80%RH with no condensation
Storage Temperature		-25 ~ +60°C	Humidity 20 ~ 80%RH with no condensation

- [Note]
- The maximum of 3 seconds shall be waited until the camera operates normally after it is powered.
 - When used with one of our accessories such as repeater or control unit, please make sure to turn on camera power at the last. If not, camera malfunction may occur.
 - Up to +18dB Gain settings can be set with this camera. However, when over +12dB is set at high ambient temperature, image quality can be lower. Please evaluate it first.

3.2. Camera Input and Output Signals Specifications

3.2.1 12pins Circular Connector No. 11 pin: Trigger Input

- 5.0V, 3.3V CMOS level /TTL level
- Input Voltage Low: 0.5Vdc (Max), High: 2.1Vdc (Min)

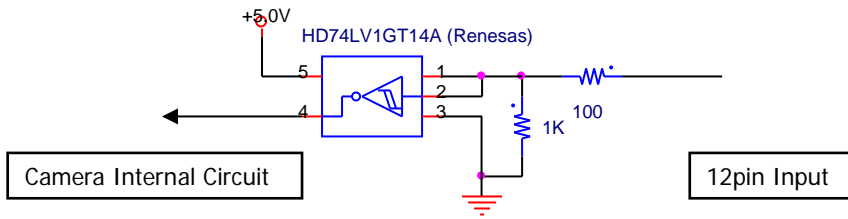

3.2.2 12pins Circular Connector No. 6, 7, 9, and 10 pin : LVAL, FVAL, Exposure, and DVAL output

- 5.0V CMOS Logic Level output
- Output Voltage Low: 0.55Vdc (Max), High: 3.8Vdc (Min)

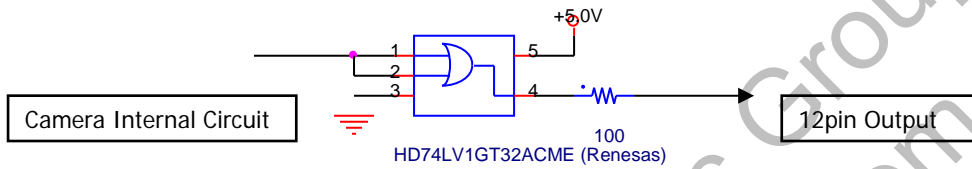

3.3. External Connector Pin Assignment

3.3.1 12 pins Circular Connector HR10-10R-12PA(73) (HIROSE) or equivalent

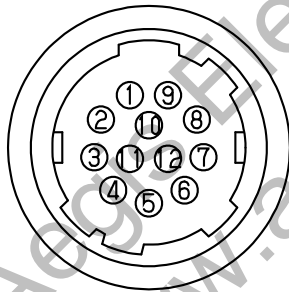

Pin No.	Description
1	GND
2	+12V
3	NC
4	NC
5	GND
6	LVAL output
7	FVAL output
8	GND
9	EXPOSURE output
10	DVAL output
11	TRIGGER input
12	GND

3.3.2 Camera Link Connector 12226-1100-00PL (SUMITOMO 3M)

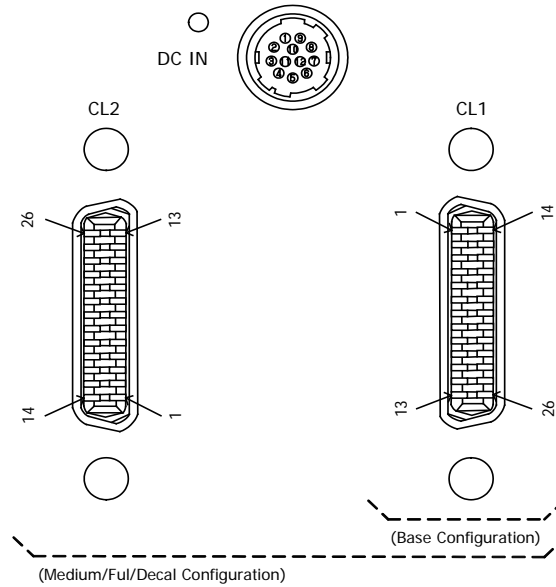

Connector (CL1)

Pin No.	Signals	Pin No.	Signals
1	GND/+12V(PoCL)	14	GND
2	X0-	15	X0+
3	X1-	16	X1+
4	X2-	17	X2+
5	Xclk-	18	Xclk+
6	X3-	19	X3+
7	SerTC+	20	SerTC-
8	SerTFG-	21	SerTFG+
9	CC1- (Trigger IN -)	22	CC1+ (Trigger IN +)
10	CC2+	23	CC2-
11	CC3-	24	CC3+
12	CC4+	25	CC4-
13	GND	26	GND/+12V(PoCL)

Connector (CL2)

Pin No.	Signals	Pin No.	Signals
1	GND/+12V(PoCL)	14	GND
2	Y0-	15	Y0+
3	Y1-	16	Y1+
4	Y2-	17	Y2+
5	Yclk-	18	Yclk+
6	Y3-	19	Y3+
7	100Ω	20	Terminated
8	Z0-	21	Z0+
9	Z1-	22	Z1+
10	Z2-	23	Z2+
11	Zclk-	24	Zclk+
12	Z3-	25	Z3+
13	GND	26	GND/+12V(PoCL)

3.3.3 PoCL/CL Selection Switch

- This is to switch PoCL power supply and power supply via 12pins circular connector (Silk Name=CL). Please make sure that power is OFF when changing the switch settings.
- Power shall be supplied only with the mode selected by the switch. If power is supplied from both, it may cause malfunction or damages to the camera.
- Factory setting is CL side (power supply via 12pins connector).

3.3.4 LED Indicator (DC IN)

When power is supplied via 12pins circular connector : Lights on

When power is supplied via PoCL

Lights on : When power is supplied from both CL1 cable and CL2 cable.

Blinking : When power is supplied only from CL1 cable or CL2 cable at the start of supplying power.

If power is not supplied from either cables properly, the camera will be stand-by status and do not start operating. Check the status of PoCL with F/G manufacturer.

※Please make sure to supply power from two cables since the current needed for this camera is more than the one that one cable can supply.

Lights out : Power is not supplied. Please check the connection of power.

[Note]

- If power is supplied only from one cable while supplying power with PoCL setting, the camera would not be stand-by status but would continue its operation. However, you can check abnormal output images with black out function, or abnormal operation with error register (Address 10). When power supply error occurs with PoCL setting, check the camera connection immediately.

3.4. CMOS Spectral Response

※The lens characteristics and illuminant characteristics are excluded.

Quantum Efficiency

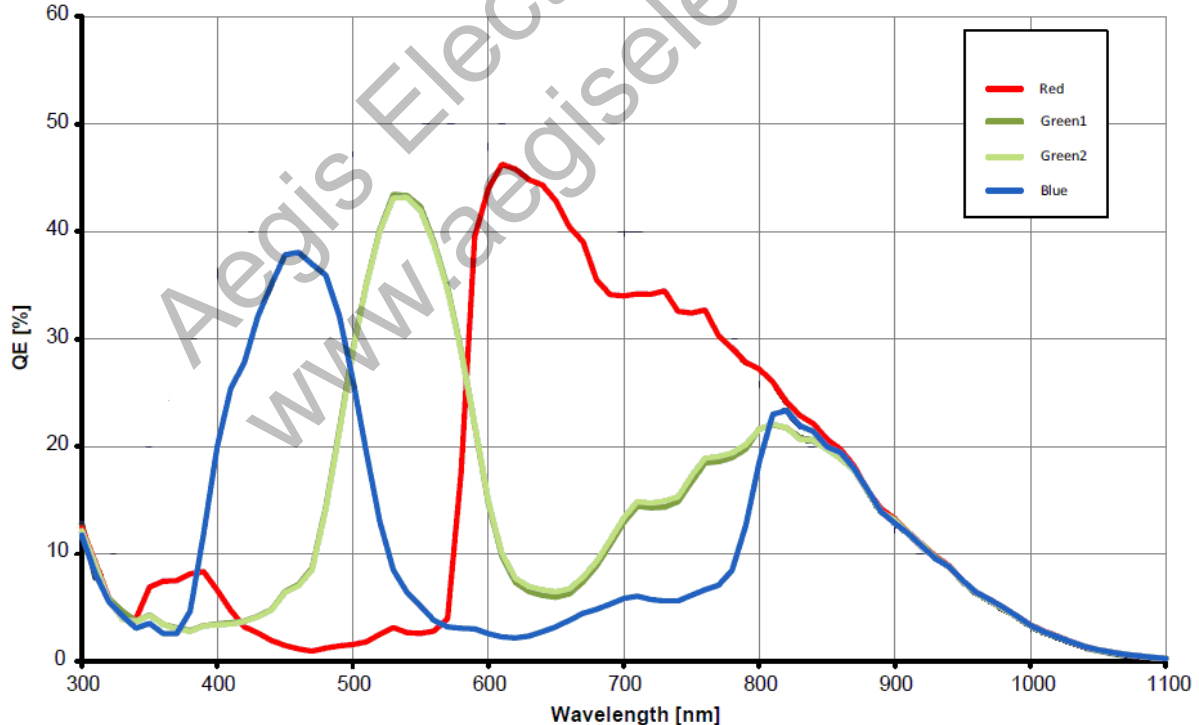

3.5. Video Output Format

Bayer: RGGB

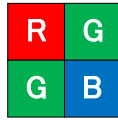

- 8Tap Full Configuration Mode : at Full Frame Scan output



- 10Tap 8bit Configuration Mode : at Full Frame Scan output

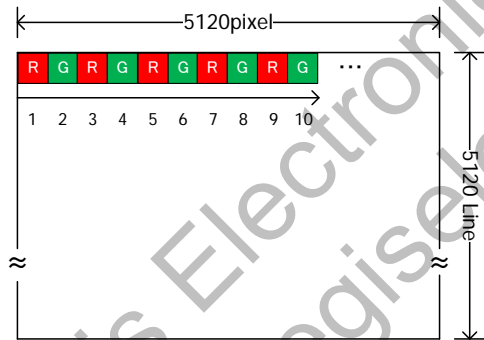

Aegis Electronic Group
www.aegiselect.com

3.6. Timing Chart

3.6.1 Horizontal Synchronous Signals Timing (8Tap Full Configuration mode: 21.54fps/24.95fps) Factory Setting

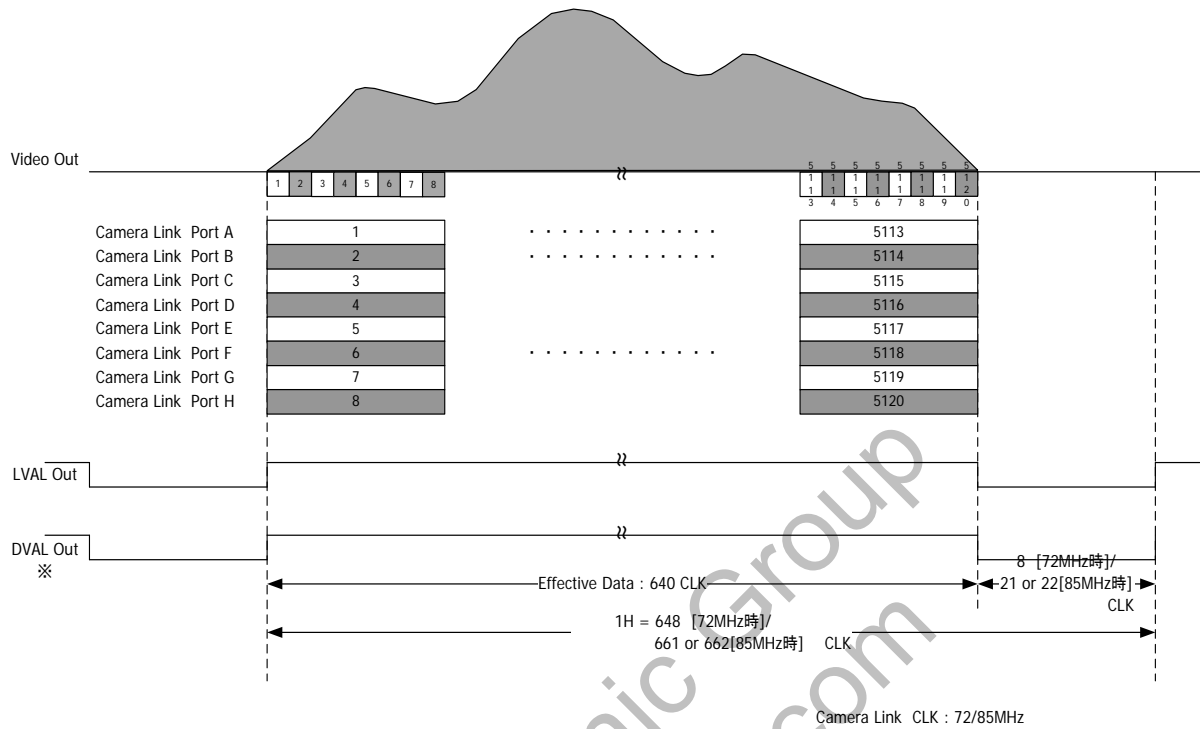

3.6.2 Horizontal Synchronous Signals Timing (10Tap 8bit Configuration mode : 31.96fps)

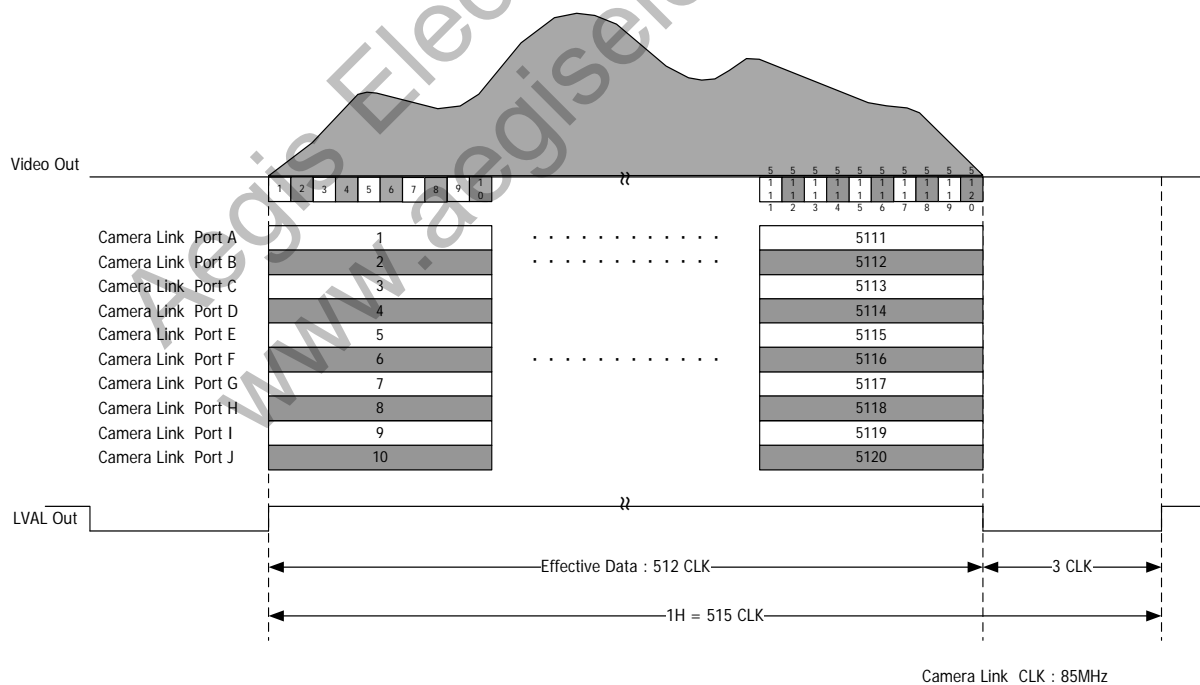

4. Camera Operational Specifications

4.1. Camera Operational Mode

Full frame scan (5120 pixels x 5120 Lines fixed) mode, Custom ROI, Multiple ROI mode, and Sequence control mode are selectable with this camera, VCC-25CL1R.

Each mode cannot be selected at one time. Some function also cannot be selected at the same time.

[Note]

- When changing mode settings, synchronization may be jumbled.

4.1.1 Custom ROI Mode (Region of Interest)

This is the mode to make the frame rate faster by cutting and reducing the area to be read out.

- ROI Horizontal effective pixels can be specified per 64 pixels.
- ROI Vertical effective lines can be specified per 2 pixels.
- The start pixel position from the Horizontal left of ROI can be specified per 64 pixels.
- The start line position from the Vertical top of ROI can be specified per 2 pixels.
- The start pixel position and start line position shall be set as follows.

$$\text{Effective pixel number} + \text{Start pixel position} \leq 5120,$$

$$\text{Effective line number} + \text{Start line position} \leq 5120$$

Frame rate list for reference

Horizontal ROI

XSIZE	YSIZE	10TAP	8TAP 85MHz	8TAP 72MHz
5120	5120	32.0	25.0	21.5
4096	5120	36.9	27.8	23.6
3840	5120	38.6	28.7	24.3
2560	5120	49.6	34.4	28.2
1920	5120	49.6	38.2	30.7
1280	5120	49.6	42.9	33.7
640	5120	49.6	48.9	37.3
64	5120	49.6	49.6	41.3

Unit [fps]

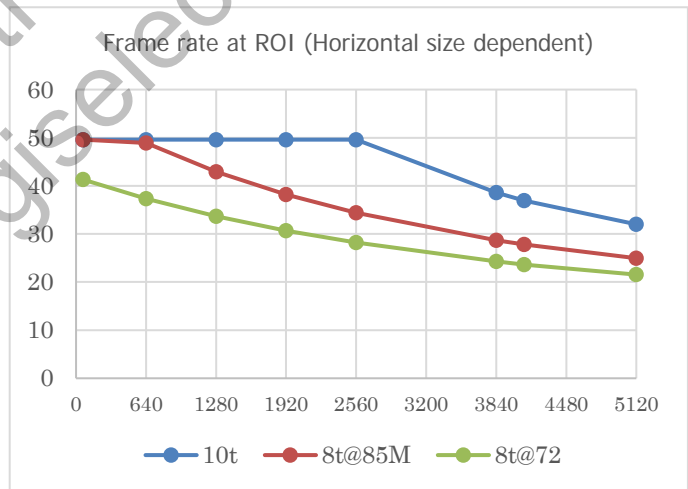

Vertical ROI

XSIZE	YSIZE	10TAP	8TAP 85MHz	8TAP 72MHz
5120	5120	32	25	21.5
5120	4096	39.3	30.7	26.5
5120	3072	52.2	40.7	35.2
5120	2896	55.3	43.1	37.3
5120	2048	77.5	60.4	52.3
5120	1024	150	117	101
5120	480	301	235	203
5120	2	2479	1934	1673

Unit [fps]

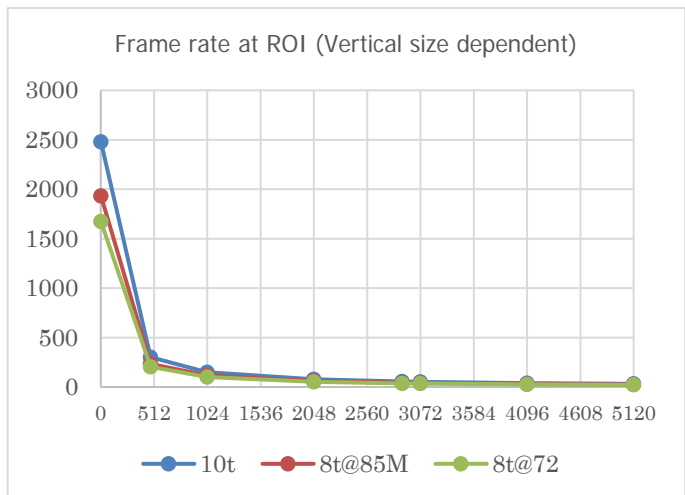

4.1.2 Multiple ROI Mode

- The maximum of 32 ROI can be set.
- The start pixel position from the Horizontal left of ROI can be specified per 128 pixels.
- The start line position from the Vertical top of ROI can be specified per 2 pixels.
- ROI Horizontal effective pixels can be specified per 128 pixels.
- ROI Vertical effective lines can be specified per 2 pixels.

[Note]

- To use Multiple ROI mode, make sure to change the mode to camera operational mode (Address 41) first, then execute Multiple ROI (Address 408). When no error is found in the parameter, Multiple ROI mode starts. Multiple ROI mode does not start by only switching camera operational mode.
- To end Multiple ROI mode, change the camera operational mode (Address 41) to other mode.
- When camera operational mode is at Multiple ROI mode, CMOS Sensor Reset (SU 29 2) or Output bit Length and Tap Width (SU 40) cannot be executed.
- Custom ROI mode and Sequence control mode cannot be set at the same time.
- **Make sure to turn OFF Shading correction and Defective pixel correction function while using Multiple ROI mode.** Multiple ROI mode cannot be used when Shading correction and Defective pixel correction function are ON.
- All Horizontal effective pixel number while using Multiple ROI mode shall be set to the same pixel number.
If different horizontal effective number is set, if the start position of Y coordinate is overlapped, or if effective area is overlapped, settings shall be invalid.
- SAVE (Command SU 5) or INIT (Command SU 0) are invalid when camera operational mode is at Multiple ROI mode. If you wish to set SAVE or INIT, set them manually after turning power ON. Other parameters for Multiple ROI can be saved by SAVE command (Command SU 5).

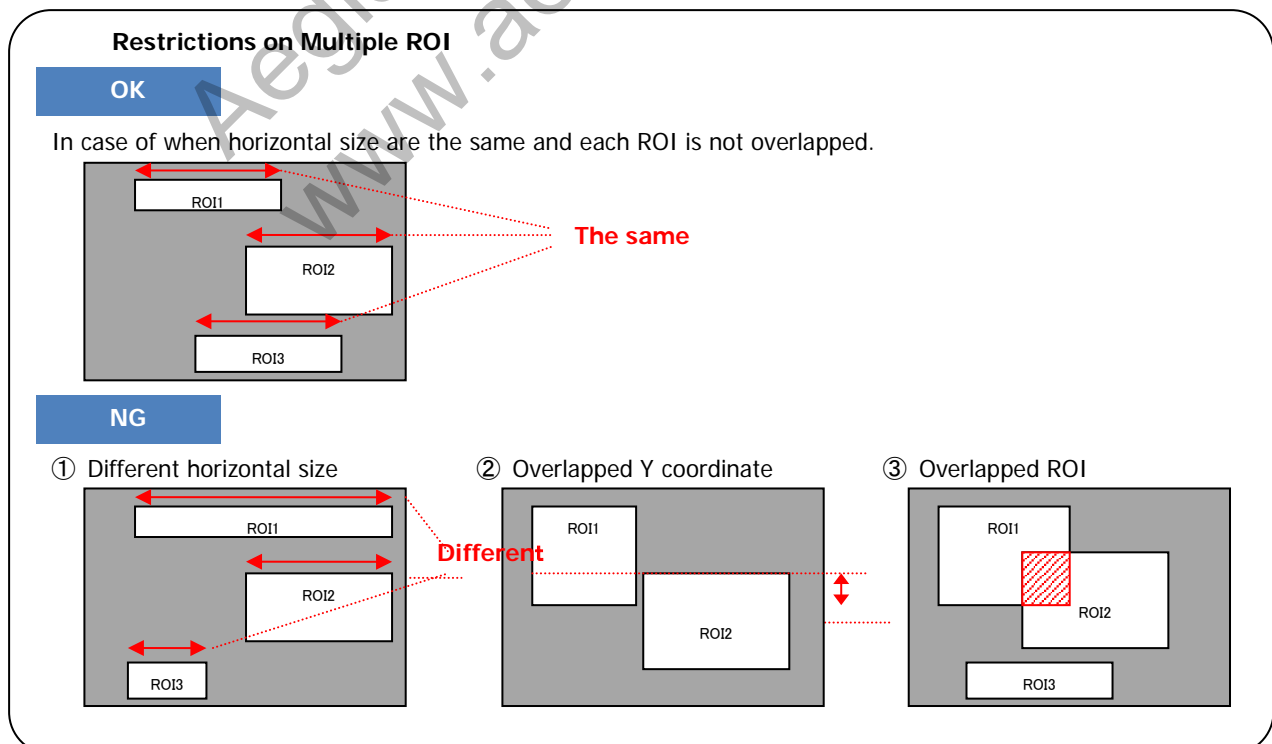

4.1.3 Sequence Control Mode

- This is the function to select one set out of the several preset parameter sets per every trigger input and apply it to the camera.
- Eight different kinds of parameter sets can be preset. The following parameters can be set per each set.
Settable parameter: Shutter, Gain, Horizontal start pixel, Vertical start line,
Horizontal effective pixel number, and Vertical effective line number
- Operational sequence is specified as "Index". The parameter set number to be applied is specified for the maximum of eight Indexes.
- There are three types of control modes, Burst mode, Step mode1, and Step mode 2.

[Note]

- ◆ Timing Regulations
Timing restrictions of trigger input for Sequence control is the same as the one for normal mode.
CC2~4 signals have to be determined by the time of trigger input. (setup time = 50[ns])
- ◆ To set parameter settings for sequence control, sequence control (Address 500) needs to be OFF.
- ◆ When camera operational mode is in sequence control mode, some restrictions apply for changing some commands, which are Trigger (Address 50~), Gain (Address 100~), and Shutter (Address 110~).
- ◆ When camera operational mode is in sequence control mode, CMOS sensor rest (SU 29 2) or output bit length and tap width (SU 40) cannot be executed.
- ◆ If a trigger had been input in the camera, sequence may start when sequence control mode is changed. Please make sure not to input any trigger when changing sequence control mode.
- ◆ When using sequence control mode, make sure to change camera operational mode (Address 41) first. Then, execute sequence control (Address 500) to start sequence control mode. Sequence control mode does not start by only switching camera operational mode.
- ◆ To end sequence control mode, or to switch to other operational mode, make sure to turn OFF sequence control (Address 500) first, then change it to other modes. Camera operational mode can be changed only when sequence control is OFF.
- ◆ Exposure time to be input to each parameter set is limited by Output Tap width, Horizontal effective pixel number, and Vertical effective line number to be used.
- ◆ Custom ROI mode and Multiple ROI mode cannot be set at the same time.
- ◆ **Make sure to turn OFF Defective pixel correction function while using Sequence control mode.** Sequence control mode cannot be used while Defective pixel correction function is ON
- ◆ SAVE (Command SU 5) or INIT (Command SU 0) are invalid when camera operational mode is Sequence control mode. If you wish to set SAVE or INIT, set them manually after turning power ON. Other parameters for Sequence control can be saved by SAVE command (Command SU 5).
- ◆ To stop Burst mode of Sequence control mode (Sequence control OFF), camera operation may be unstable for one frame.

Start and Stop of Sequence operation are selectable from edge start by using trigger input signals, level start, and Soft start.

(1) Edge Start

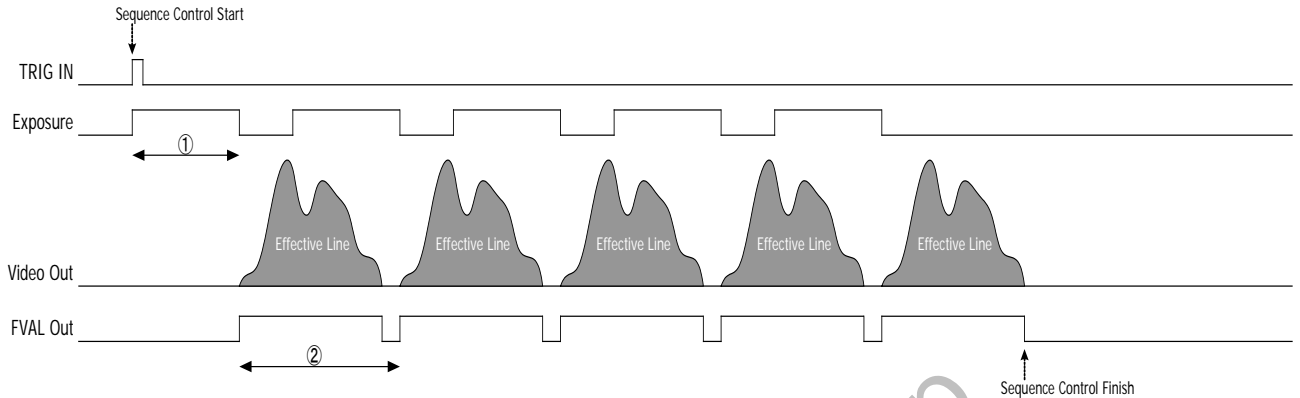

- Sequence operation starts by a trigger input.
- Exposure time for each frame (①) and output frame time (②) are controlled by the pre-specified sequence parameter set and its image size settings.
- When video output for the specified sequence Loop count completes, sequence operation ends and so as its operation.

(2) Level Control

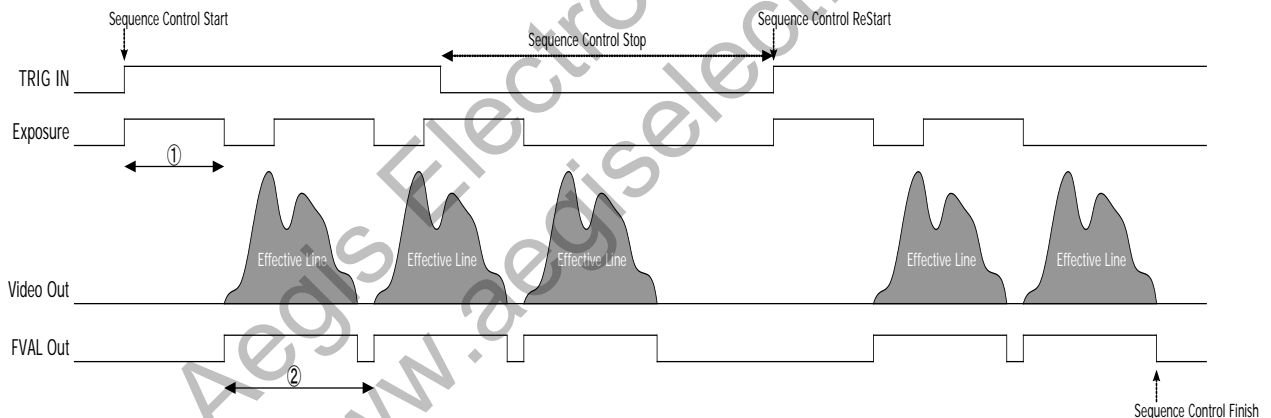

- Sequence function is in operation while trigger input is at High level.
- To interrupt sequence function, change the trigger input to Low level.
- While interrupted, change the trigger input to High level again to resume its operation.
- When video output for the specified sequence Loop count completes, sequence operation ends and so as its operation.

(3) Soft Start

- When Sequence control Burst mode, soft start is set, sequence operation is executed as the same way as edge control.

4.1.3.2 Sequence Control Step Mode 1 Operational Outline

Sequence operation is controlled by edge control with trigger input signals. Exposure time for each frame is controlled by the pre-specified sequence parameter set. There are two modes, one is to specify the Index flow in advance, and the other is to specify the Index with CC2, CC3, and CC4 signals. (Repeating count for each Index, Index number to use, and Loop count can be set). The specified index parameter set is applied to the camera every time a trigger is input. The last parameter is executed by inputting a trigger after sequence operation is completed, meaning after Index repeat count is completed. If you wish to re-execute sequence function from the beginning, turn OFF sequence control once, then set Step mode again.

Operational Flow (Step Mode 1 Index Parameter control)

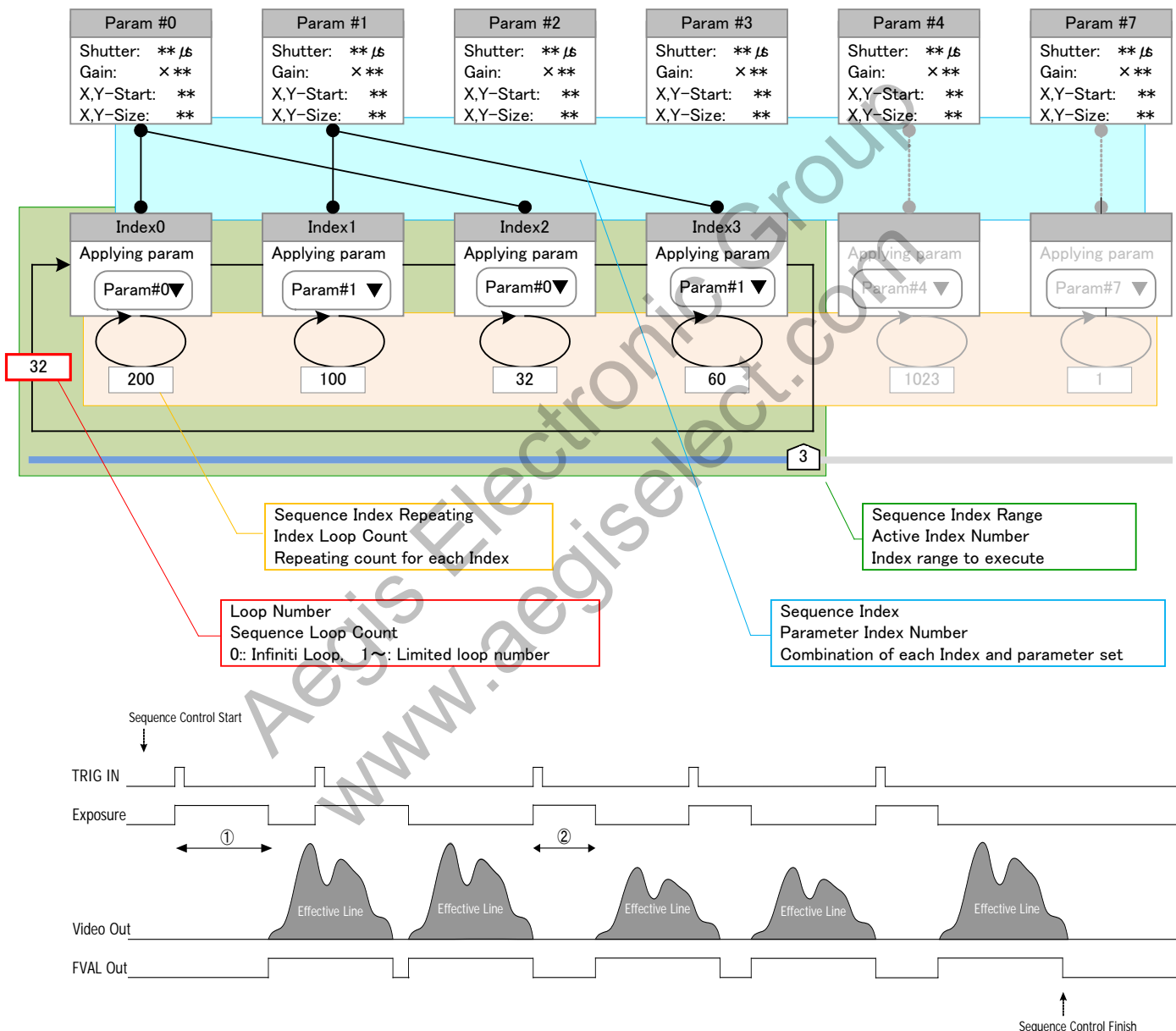

- Sequence starts by a trigger input.
- Exposure time for each frame (① ②) are controlled by the pre-specified sequence parameter set.

Operational Flow (Step Mode 1 CC2~4 Parameter Control)

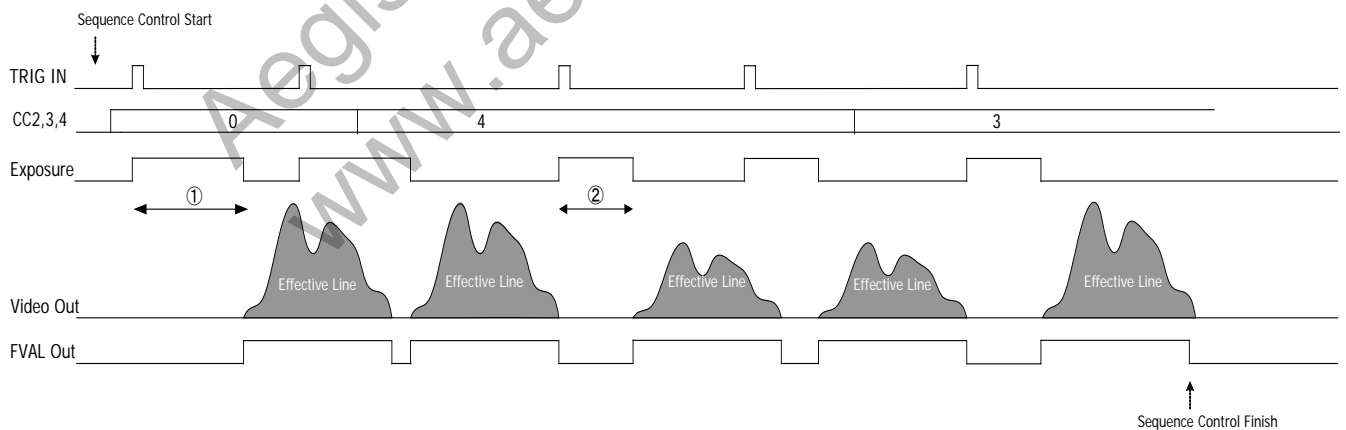
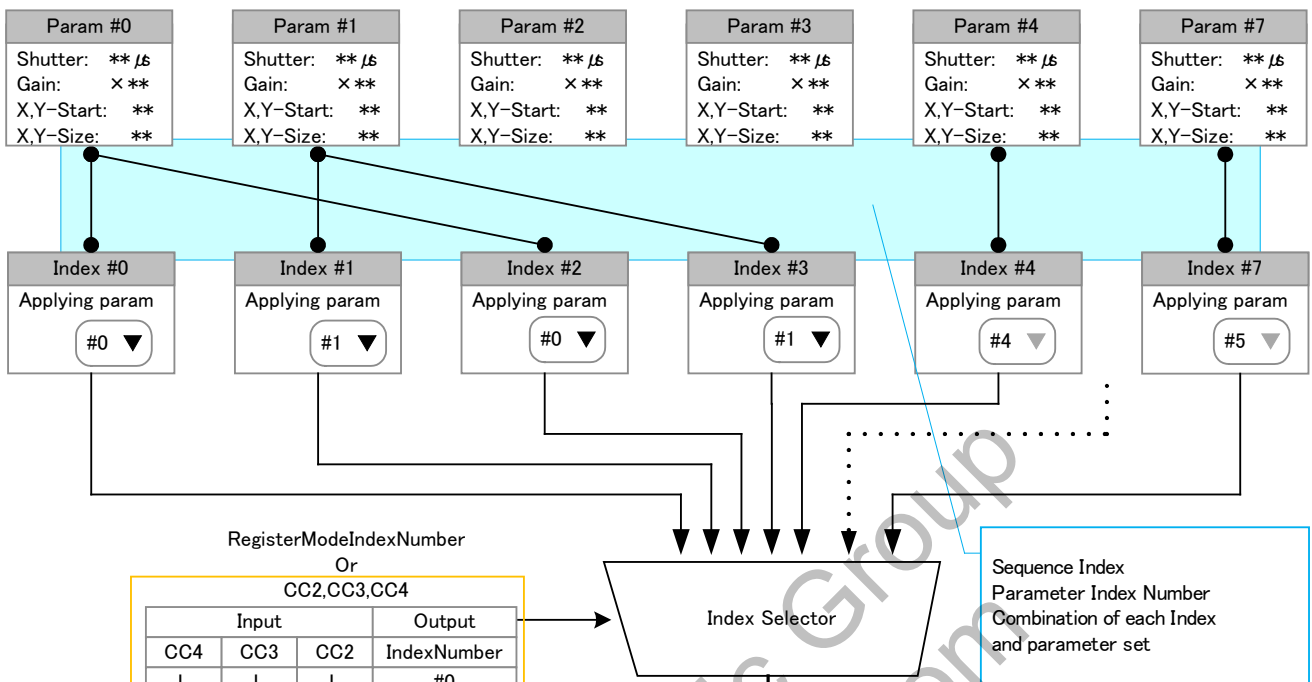

- Sequence starts by a trigger input.
- Exposure time for each frame (① ②) are controlled by the pre-specified sequence parameter set.
- With CC control, CC2, CC3, and CC4 shall be determined before the trigger is input.

4.1.3.3 Sequence Control Step Mode 2 Operational Outline

Sequence operation is controlled by pulse width control with trigger input signals. Exposure time for each frame is controlled by the pre-specified sequence parameter set. **Trigger pulse width becomes the exposure time for each frame, and exposure time of the parameter set shall not be referred.**

There are two modes, one is to specify the Index flow in advance, and the other is to specify the Index with CC2, CC3, and CC4 signals. (Repeating count for each Index, Index number to use, and Loop count can be set). The specified index parameter set is applied to the camera every time a trigger is input. The last parameter is executed by inputting a trigger after sequence operation is completed, meaning after Index repeat count is completed. If you wish to re-execute sequence function from the beginning, turn OFF sequence control once, then set Step mode again.

Operational Flow (Step Mode 2, Pulse Width Trigger Index Parameter control)

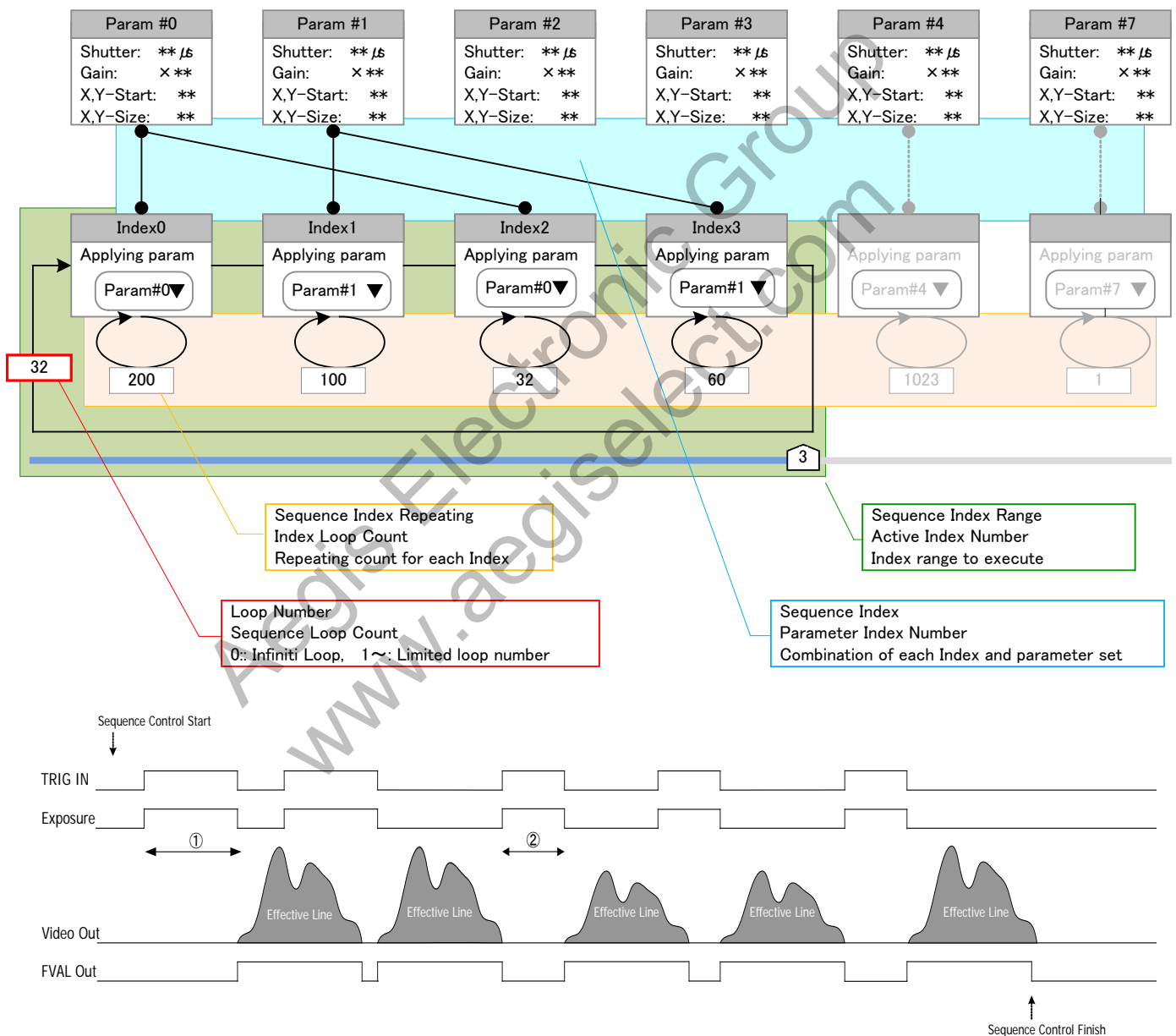

- Sequence starts by a trigger input.
- Exposure time for each frame (① ②) are the trigger pulse width.
- Exposure time of the parameter set is not referred.

Operational Flow (Step Mode 2, Pulse Width Trigger CC2~4 Parameter Control)

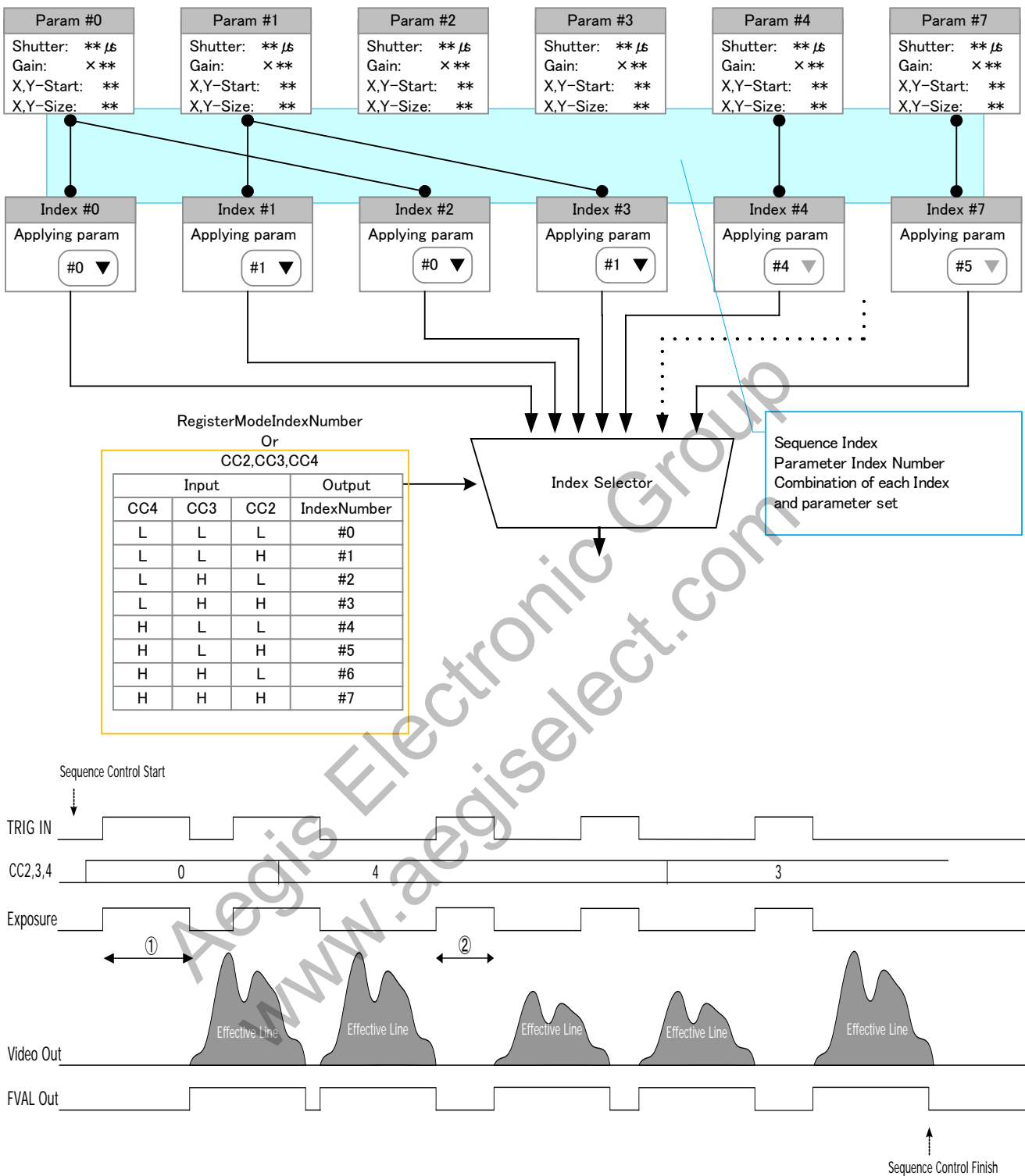

- Sequence starts by a trigger input.
- Exposure time for each frame (① ②) are the trigger pulse width.
- Exposure time of the parameter set is not referred.
- With CC control, CC2, CC3, and CC4 lines shall be determined before the trigger is input.

4.1.3.4 Image Output of Sequence Status

While sequence operation in Burst mode and in Index parameter control, the sequence status of each frame can be read out with the Address 507. It can also be shown in the output effective images by embedding the status in it.

The position to embed the status information shall be at the Top Left (fixed) with five pixels.

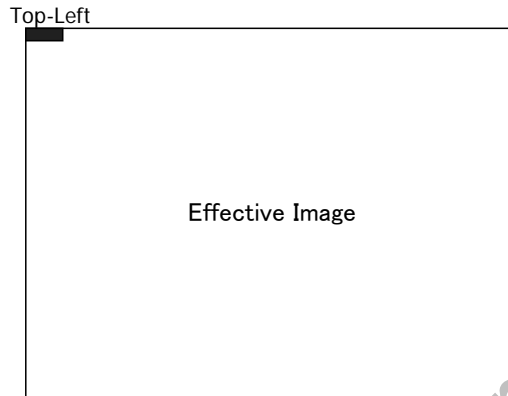

Index number, Index repeat count number, and Loop number for each pixel are output as shown below.

	MSB	LSB
pix0	Index Number[3:0]	"0000"
pix1	Repeat Count Number [7:0]	
pix2	"000000"	Repeat Number [9:8]
pix3	Loop Number[7:0]	
pix4	"000000"	Loop Number[9:8]

※ Index Number is shown as 0~7.

Repeat Count Number is shown as 1~1023.

Loop Number is shown as 1~1023 and when it reaches to the upper limit, its indication stops at 1023.

4.2. Gain Settings

This is to increase video output level by the preset gain or manual gain. When the preset value is set, it is reflected to the manual setting value. Manual setting values would never be reflected to the preset values. Preset values are not data saved.

※ Functionally, gain up function is available up to +18dB. However, the image quality will be reduced when gain setting becomes high. We recommend you to evaluate it first

Preset Gain (Digital)

Setting Values	Decibel Values
0	0dB
1	6.0dB
2	12.0dB
3	18.0dB
15	Manual

Manual Gain

Set the above gain registers to manual to set manual gain values.

Any preferred values from 0dB to +18dB can be set.

※ x100 equivalent values shall be set (Only 00, 25, 50, and 75 can be set as the lower two numbers).

Setting Examples

1. In case of when setting +3.25dB with Manual gain

SU 100 15

SU 101 325

2. In case of when setting +10.5dB with Manual gain

SU 100 15

SU 101 1050

4.3. Settings of Exposure Time

Exposure time can be set. When the preset value is set, it is reflected to the manual setting value. Manual setting values would never be reflected to the preset values.

Preset Shutter Mode

This is to use the preset value set in the camera. Please refer to the Section 5.2.1, for the details on the preset values.

Manual Shutter Mode

When the preset mode is set to manual control, any preferred exposure time can be set.

Exposure time can be set per 1us. The minimum exposure time is 30us and the maximum exposure time varies depending on ROI settings. If a bigger value than the frame rate of the image size is set, exposure time shall be clipped with the maximum exposure time for the image size to be used.

[Note]

- Shutter Values

Manual shutter values for this camera, VCC-25CL1R, is 1/32~1/30000[s] (Exposure time 31250 ~ 30[us]). For longer time usage, please select pulse width trigger shutter mode. However, please be noted that it is inevitable that image quality will be reduced at long time exposure due to ambient temperature or high gain. We recommend you to evaluate first.

- Shutter Lines

Exposure for the next frame can be started (overlapped) while outputting video signals for the prior exposure. However, please be noted that shutter lines may be noticeable depending on the camera operational mode or gain settings to be used. In such case, please try to change the setting values of the register (Address 251), which might work.

- Clipping of Shutter Values

Shutter values shall be clipped depending on its ROI settings in case of when image output size is set to small size by custom ROI function and others. (Shutter values are to be clipped with the maximum exposure time of the ROI settings to be used). In such case, the clipped values at Manual control setting (Address 111) can be read. And, if video output size is changed to bigger size and set back to the original size, the value returns to the preset values. However, please be noted that the values do not return to the original (preset) values when it is clipped at Manual shutter mode (Address 110, Data 15).

(Example)

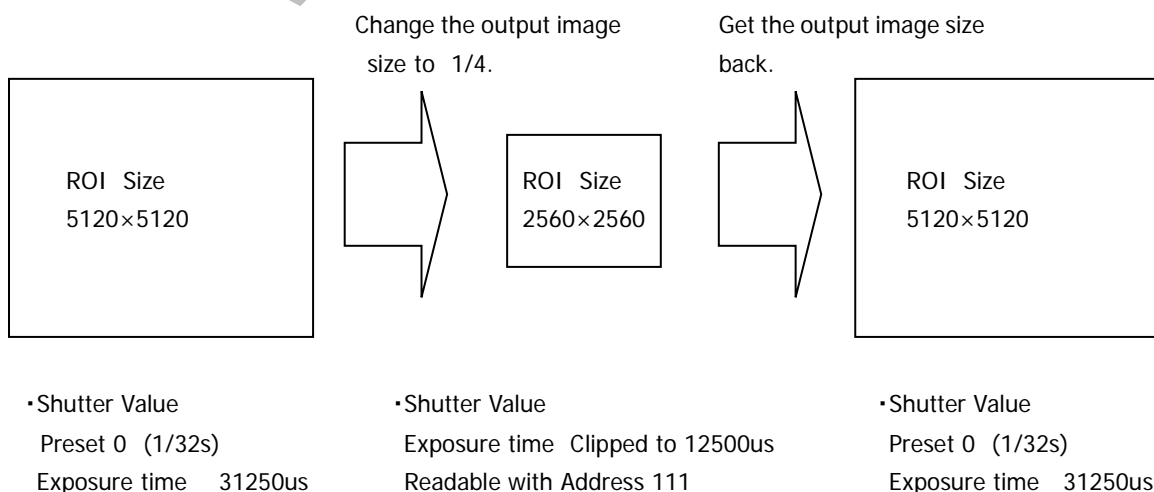

4.4. Trigger Mode

4.4.1 Fixed Trigger Shutter Mode

- This is the mode to start exposure with external input trigger signals, and set the exposure time with serial commands.
- Trigger operation is CLK Sync HV-Sync Reset system.
- Trigger input between Exposure Time Start to actual reading out shall be ignored in the camera [(A) in the chart below]. When video read out (FVAL=1) and Exposure Start (rising edge of Exposure Time) are overlapped, LVAL and DVAL would output Low for approx. 2H, and stops outputting video.

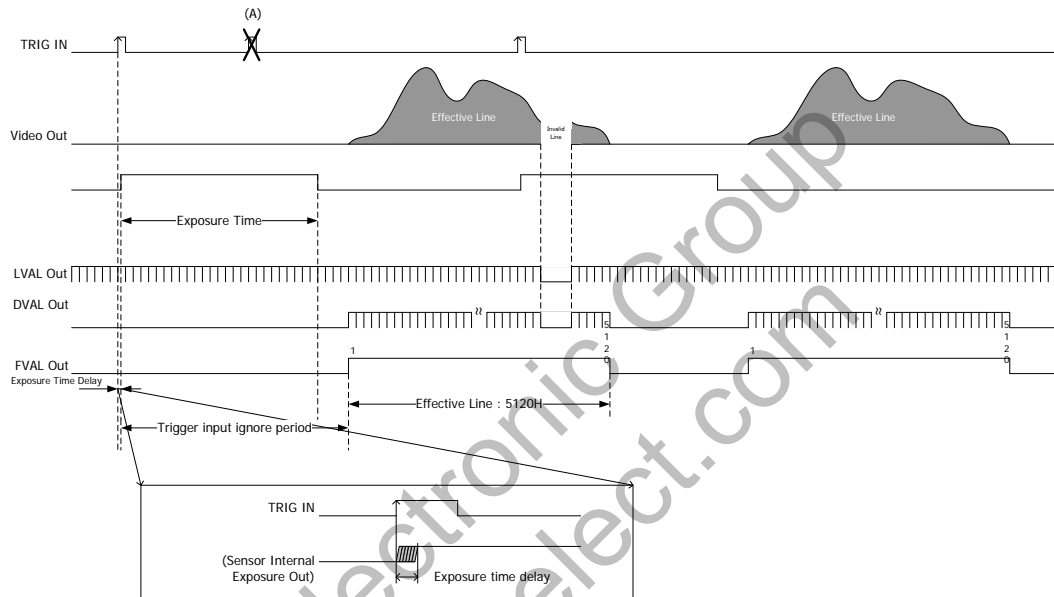

[Note]

- ◆ The minimum setting value for Fixed Trigger Shutter Mode is **30us**.
- ◆ The next trigger while outputting video for the prior trigger can be accepted. However, do not input a trigger signal to start the next video outputting before completion of outputting the prior images.

The delay time from detecting the trigger edge in the camera to actually starting exposure is as follows.

Exposure Time Delay	Output Tap Number		
	72MHz	85MHz	
	8Taps	8Taps	10Taps
Delay Time (Non-Overlapped)	10us	10us	10us
Delay Time (Overlapped)	15us	15us	12us

※ Several tens ns jitter would occur to the delay time above since it is non-synchronized capturing.

4.4.2 Pulse Width Trigger Shutter Mode

- This is the mode to start exposure with external input trigger signals, and set the exposure time with pulse width of the trigger signals.
- Trigger operation is CLK Sync, HV-Sync Reset system. When video read out (FVAL=1) and Exposure Start (rising edge of Exposure Time) are overlapped, LVAL and DVAL would output Low for approx. 2H, and stop outputting video.

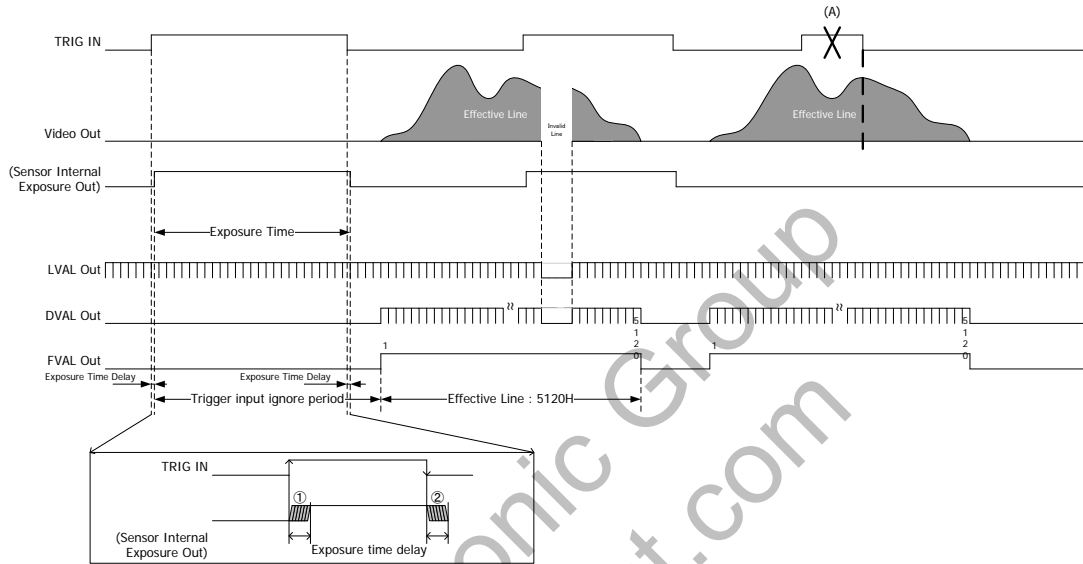

[Note]

- ◆ The pulse width is 30μs ~ approx. 2 frames. Functionally, there is no upper or lower limitations but at long time exposure, noise increase or decrease of setup level and white clip level could be noticeable.
- ◆ The next trigger while outputting video for the prior trigger can be accepted. However, do not input a trigger signal to start the next video outputting before completion of outputting the prior images [(A) in the above chart].
- ◆ The delay time (Exposure Time Delay ①) from detecting the trigger edge in the camera to actually starting exposure, and the delay time (Exposure Time Delay ②) from detecting the trigger completion edge to actually ending exposure are as follows.

Exposure Time Delay①	Output Tap Number		
	72MHz	85MHz	
	8Taps	8Taps	10Taps
Delay Time (Non-Overlapped)	10us	10us	10us
Delay Time (Overlapped)	15us	15us	10us

Exposure Time Delay②	Output Tap Number		
	72MHz	85MHz	
	8Taps	8Taps	10Taps
Delay Time (Non-Overlapped)	25us	25us	25us
Delay Time (Overlapped)	25us	25us	20us

※ Several tens ns jitter would occur to the delay time above since it is non-synchronized capturing.

4.4.3 Camera Operation when inappropriate trigger is input

The next trigger while outputting video for the prior trigger can be accepted in both Fixed Trigger Shutter Mode and Pulse Width Trigger Shutter Mode. However, do not input a trigger signal [(A)] to start the next video outputting before completion of outputting the prior images. In other words, exposure can start while outputting FVAL but no trigger to end exposure while outputting FVAL shall be input. If an inappropriate trigger is input, camera exposure time could be unstable or camera operation could be stopped.

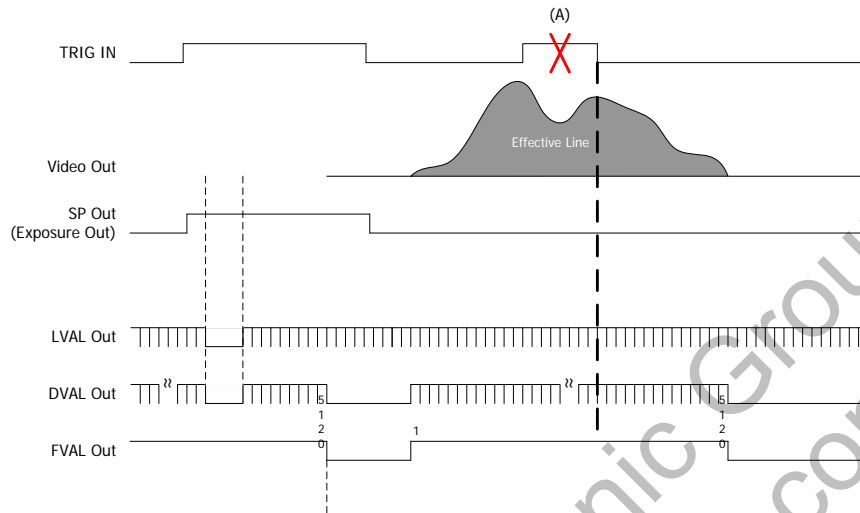

- Camera Operational Error Register (Address 10)

If an inappropriate trigger is input at trigger mode operation, it returns 2 to confirm the error. However, the re-input trigger before completion of exposure time at Fixed Trigger Shutter Mode shall be ignored, so that error cannot be confirmed.

- CMOS Sensor Reset (Address 29)

If an inappropriate trigger is input, the sensor might be stopped. This is the register to restore the problem. In case of when output video becomes black out, camera operational error register (Address 10) returns 2, and the camera stops its operation, check if there are any inappropriate trigger input or not. If there are any inappropriate trigger input found, provide an appropriate trigger and issue this reset signal. With issuing the reset signal, the camera shall return to the currently set status.

4.5. White Balance

- The following three kinds of modes can be used for White Balance.

0, OFF

Through output without white balance adjustment.

1, Manual

Red and Blue Gain are adjustable with the following commands in the range of 0~800%.

2, One Push

White balance is adjusted to the output image of when one push start (Address 141) is executed.

[White Balance Gain reference value]

The followings are the reference values of white balance gain for each color temperature.

Color Temperature [K]	WB-R Gain (%)	WB-B Gain (%)
8000	193	101
3200	134	163
2200	104	196

※ These values are only your reference. Please adjust white balance gain under the actual environment to be used.

[Note]

- To use one push start, multiple ROI mode and Sequence mode shall be OFF.
- With white balance, minus gain under 100% can be input to R element and B element. Color element with gain under 100% may saturate before the output level reaches 255 (1023 in case of 10 bit output). Therefore, please be careful when using minus gain.

4.5.1 One Push Start

- This is to adjust white balance of the output image.
- Shoot a image with no color to full screen to execute this function. We recommend to execute this function with approx. 50% of signal level.

[Note]

- To execute one push start, multiple ROI mode and Sequence shall be OFF.
- All R, G, and B color shall not be saturated to execute one push start.
- One push start shall be executed only when the camera is in operation. (One push white balance gain cannot be acquired when camera is not outputting anything.)
- Valid when white balance select (Address 140) is set to 2, OnePush.

4.6. Shading Correction

- This is a function to correct the peripheral brightness lowering caused by the lens and others used.
- Set the shading correction data in advance, then turn ON shading correction (Address 906) to start.
- The maximum of three correction patterns can be kept. You can choose the patterns with shading selection (Address 908).

◆ Before Shading Correction

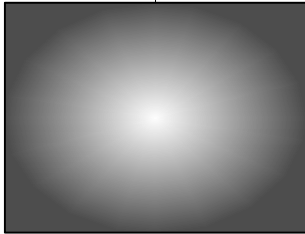

◆ After Shading Correction



[Note]

- This function cannot be set at Multiple ROI mode.
- The maximum 200msec is needed to change shading correction patterns. (including command response time)
- Shading selection (Address 908) shall be performed while camera is outputting signals.

4.6.1 Detect Shading Correction Data

- Shoot a uniform object such as a pattern box, to full screen, then execute Detect Shading (Address 907), to calculate and set the correction data automatically in the camera. We recommend detecting shading with medium brightness of output level (128 at 8 bit output, and 512 at 10bit output). In case of when some area of output level is saturated (255 at 8 bit output, and 1023 at 10 bit output), or black (output level 0), proper shading correction data would not be obtained. With shading selection (Address 908), where to set can be selected.

[Note]

- To acquire correction data, camera operational mode (Address 41) shall be full frame scan.
- Shading correction data can be acquired only when the camera is in operation. (Shading correction data cannot be acquired if the camera is outputting no signals).
- Each correction data can be saved in the camera by issuing SAVE command (SU 5).
- By issuing INIT command (SU 0), entire correction data can be deleted but please be noted that other setting data will be restored to the factory settings as well.
- When obtain correction data with trigger shutter mode, the data sometimes becomes unstable. In this case, change the trigger cycle in small measure and obtain correction data again.

4.7. Gamma Selection

Gamma correction can be performed.

- In addition to ON/OFF, 0.45 and user customizing gamma correction can be selected.
- Gamma correction is performed by the table of 257 points, which are 0~256points to the input level (10 bit width fixed). If no data was found on the table, the closest table data of both sides are used to do linear interpolation. Please refer to the [Section 4.7.2. User Customizing Gamma Table](#) for the details.

4.7.1 Gamma Selection

Two kinds of gamma, user customizing gamma and 0.45 can be selected.

【Note】

- Gamma selection cannot be changed when camera is not outputting any signal.

4.7.2 User Customizing Gamma Table

Users can set any preferred gamma tables. Turn gamma correction (Address 200) ON, and select User Customizing Correction with gamma selection (Address 201) to check the settings of the table.

There are 257 points for the table addresses, 0 ~ 256. And for each table, 0 ~ 1024 data can be saved by issuing SAVE command (SU 5). With INIT command (SU 0), this table can be restored to the initial setting, Gamma 0.45.

The figure below shows the relation between Input data (InputLevel), Gamma table (TableAddress), and Output data (OutputLevel).

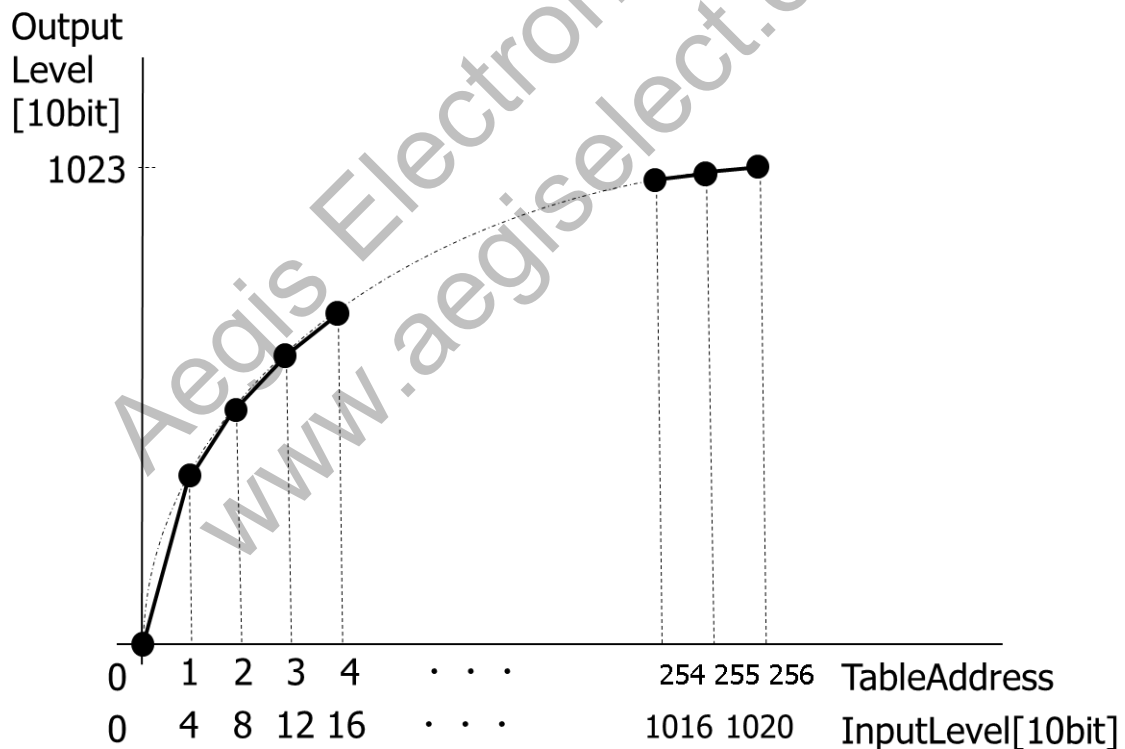

For gamma correction, input and output are calculated per 10 bits.

For example, input data of multiple of 4, such as 0, 4, 8 , 1016, 1020, shall be converted to the table data.

The relation between the table and the input data is one (table) to four (data). When input data are 1, 2, and 3, the data shall be linear interpolated from the table 0 and 1. So as when the input data is 1023, the data shall be linear interpolated from the table 255 and 256. Data values 0 ~ 1024 can be input to each Table address.

- By changing the User Customizing Gamma Table, users can correct data with any preferred gamma values. Besides, not only gamma correction but also flipping output level and converting the output level to any preferred level can be done.

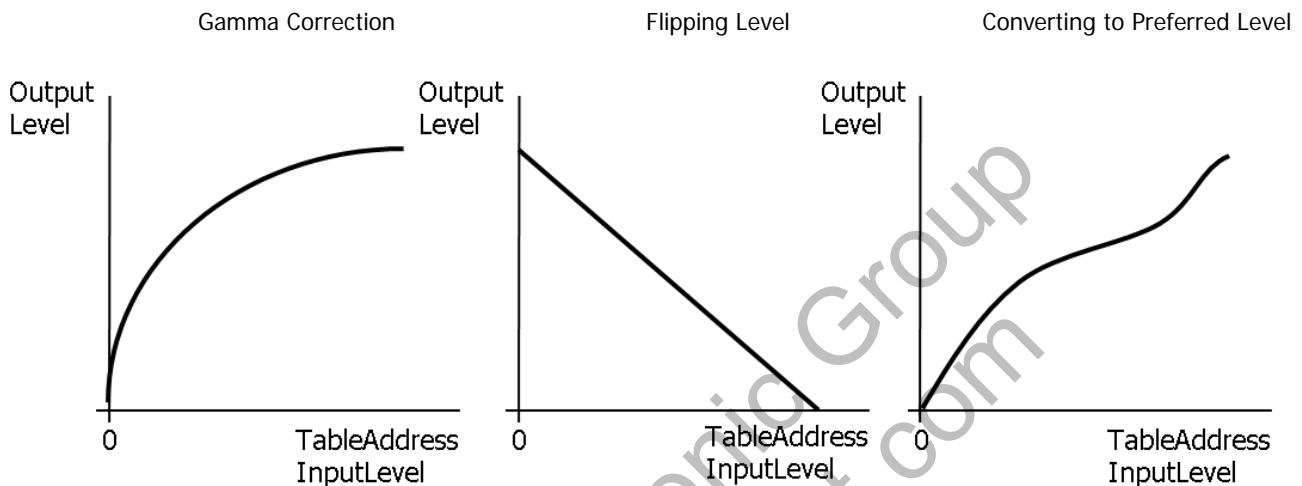

[Note]

- ♦ The changed values by the User Customizing Gamma Table shall be reflected immediately. Therefore, output images while changing the User Customizing Gamma Table might not be proper images.
- ♦ The data can be restored to the initial value, 0.45, by issuing INIT command (SU 0). However, please be noted that other setting data are restored to the factory settings as well.

4.8. Black Level Adjustment

- Black Level is adjustable.

[Note]

- ♦ Black level is adjustable with relative values. When it is increased or decreased by 1, its luminance level changes by approx. 0.25 at 8 bit output, and it changes by approx. 1.0 at 10 bit output.
- ♦ When the lower values than the initial value are set, saturation level would not achieve the maximum value for output range.
- ♦ Black level shall be adjusted to be the deepest black in advance, when using sequence control mode.

4.9. Test Pattern Indication

- Test pattern can be output from the camera. It is useful to check if your system is operating properly.

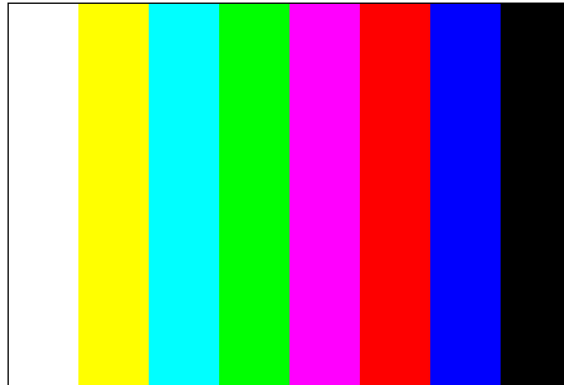

[Note]

- ◆ Gain, Shading correction, Defective pixel correction, Black level adjustment, and Gamma correction function will be OFF automatically.
- ◆ This function cannot be set when cursor indication is ON.
- ◆ User white defects detection, shading detection, and white balance one push start cannot be performed when test pattern indication is ON.

4.10. Black Out Function

- This is the function to make the output image to be black out (for all of 00h/8bit,10bit output) at camera abnormal operation, such as when an inappropriate trigger is input at trigger mode or when power is supplied from only one side at PoCL setting. If video output image becomes black out, check the error register of the camera and restore to the normal status.

4.11. Cursor Indication

- A cursor can be indicated on the screen. Cursor X coordinate specifies the vertical cursor X coordinate, and Cursor Y coordinate indicates the horizontal cursor Y coordinate.

[Note]

- ◆ This function cannot be set when test pattern indication is ON.

4.12. Temperature Indication

This is to indicate temperature register value of the camera CMOS sensor.

[Note]

- ◆ The register value is not calibrated.

Temperature Register Values (Reference values)

Sensor Temperature [°C]	30	40	50
Device Temperature Values	94	108	122

4.13. Defective Pixels Correction Function

- This is the function to detect and correct the pixel defects in the data output from the sensor.
- Data are categorized into two types and controlled.
 - Data at Ex-Factory
 - The detected data of white pixel defects and black pixel defects at Ex-Factory are saved.
 - Basically, these data cannot be erased.
 - Data registered by users
 - Data increased after shipment or the one registered by users.
 - These data can be erased anytime by Entire Deletion of the user defective pixels (Address 914).
 - It cannot be restored by INIT command (SU 0).
- The number of data registerable by users is 1024 points. (Note: Up to 128 points per CH).

[CH (Channel)]

Images are processed by 8 CH interleave in the camera.

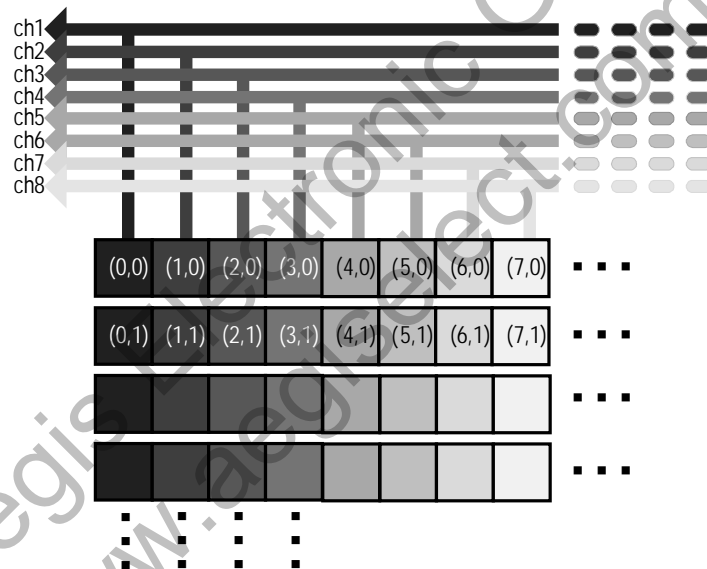

- The registerable number of pixel defects and the correctable number of pixel defects may not be always the same because of the following reasons.

- (1) With white defects detection, if one of the strip reeds reached the maximum number, correction could not be performed. In such case, the data up to that point are registered, error is output, and operation ends.
- (2) If no effective pixel exists in the same color elements with up next, down next, right next, or left next to the pixel to be corrected, this pixel can be registered but cannot be corrected.

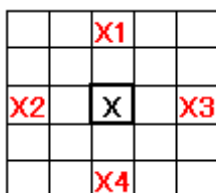

For example, when X1, X2, X3, and X4 are already registered as defected pixels, X can be added to be registered but it cannot be corrected.

White Defects Detection by the users. (Address 911)

This is the function to register the pixels automatically if a pixel exceeds the level specified by the user. Please be noted that no lights should be in the sensor surface to use this function.

There are two kinds of parameters for commands.

The First Parameter: Threshold (0~1023)

The data with luminance level more than the specified level here shall be registered.

※ 4times more value of the image signal level shall be specified as the threshold value with 8 bit image.

The Second Parameter: Additional Flag (0, 1)

When 0 is specified, all the white defects data that users registered by that time are cleared out, and data will be newly registered.

When 1 is specified, only newly detected white defects data will be added to the old data registered by that time.

One of the following messages shall be shown when white defects detect is completed.

OK: Normal

[ERROR] too many user defective pixels: Data number registered by the user exceeds the maximum (1024 points).

[ERROR] region data full: : Data SUM registered by the user and the one at ex-factory exceeds the limitation for 1 CH.

When [ERROR] is shown, please check if the threshold of the first parameter is appropriate, as well as defective pixels indication (Address 915).

[Note]

- ♦ Correction data shall be acquired only when the camera is in operation. When camera is not outputting anything, white defect detection cannot be performed.
- ♦ When detecting white defects, Custom ROI mode, Multiple ROI mode, and Sequence function shall be OFF. (Size shall be set to 5120x5120 to execute).
- ♦ After detecting, defective pixels correction function becomes ON.

Entire deletion of defective pixels data registered by users (Address 914)

This is to delete all defective pixels data detected and registered by users, with Address 911.

Please execute this when you wish to redo your detection and registration from the beginning, or when you wish to restore all the registration to the factory settings. SU 914 to execute.

[Note]

- ♦ When deleting entire defective pixels, Custom ROI mode, Multiple ROI mode, and Sequence function shall be OFF. (Size shall be set to 5120x5120 to execute).

□ Indication of Defective Pixels (Address 915)

Operations when setting data and when acquiring data are different.

(1) When setting (SU 915)

This is the function to indicate the actually corrected pixels by that time, as white. (When defective pixels correction is OFF, there is no corrected pixel so that no white is shown).

On/Off is done by parameters

Parameter 0: OFF

Parameter 1: ON

- ◇ Bright point indication function cannot be saved.
- ◇ When operation mode is changed, defective pixel indication function will be OFF.

(2) When acquiring (GU 915)

This is the function to indicate the registered defective pixels.

Three kinds of lists can be indicated by parameters.

Parameter 1: Entire list, both ex-factory data, and the added and registered data by users, are shown.

Parameter 2: Only the list added and registered by users is shown.

(Example of indication)

925	443	W
1228	460	W
1271	488	W
1098	520	W
930	629	U

From the left, X coordinate, Y coordinate, and the type of defects.

[Type of defects]

W: White defects registered at Ex-factory

B: Black defects registered at Ex-factory

U: White defects registered by the user

Parameter 3: Indicates the number of the registered defective pixels per CH.
(Data at Ex-factory + Data registered by users.)

Parameter 4: Indicates the number of the registered defective pixels per CH.
(Data registered by users only.)

Parameter 5: Error status of the registered data. Indicates if the data registered by users are appropriate.

[Notes for coordinate indication]

- X coordinate and Y coordinate shown are the one for the current image. When effective angle of field is changed by Custom ROI (SU 41) or others, the coordinates to be indicated shall be changed accordingly.
- The lists shown by parameters 3 and 4 are only the registered data in the currently shown image area.
(When indication image size was reduced, some registered data by the user could be out of area.
In such case, the coordinate points out of the indication area would not be shown.)
- To show the coordinate points of out of the area, execute parameter 1 or parameter 2. These points would be shown as minus coordinate or as the one of the out of image size.

4.14. User Data Save / Read Out Function

This is the function for users to save any data with up to 30 letters (Address 1000).

Set data to the specified address by the command, and issue SAVE command (SU 5) to save the user data.

These data shall not be restored by INIT command (SU 0).

When saving the user data, it can be controlled by a parameter. When reading out the user data, it can be controlled without any parameter.

For the protocol specifications, please refer to the Section 5. Remote Communication Function.

4.14.1. User Data Save

Set a preferred letter string in the user area.

The minimum of one letter, the maximum of thirty letters can be set.

Space can be input in the double quotation mark (*).

How to Write

【Send】SU[sp]1000 [sp] Data

【Returned Value】[¥r][¥n]

【Returned Value】>[sp]

Example to put a space

【Send】SU[sp]1000 [sp]"hoge[sp]hoge"

【Returned Value】[¥r][¥n]

【Returned Value】>[sp]

Saved Letter String【hoge hoge】

※How to restore the settings

【Send】SU[sp]1000 [sp]" " (Set a letter string in the double quotation).

4.14.2. Users Data Read Out

The set user data can be read out.

【Send】GU[sp]1000

【Returned Value】Setting Data[sp][¥r][¥n]

【Returned Value】>[sp]

5. Remote Communication Function

5.1. Serial Communication

With camera link serial communication function, the camera can be controlled via external computer and others.

(1) Settings for RS232C communication is as follows.

Baud rate	: 115200bps or 9600bps
Data	: 8bit
Stop bit	: 1bit
Parity	: None
XON/XOFF	: Not controlled

(2) Control Code

- The total control code conforms to ASCII code.
- A control code consists of command, parameter and CR (0x0d) or LF (0x0a). The changes and acquisition of camera settings can be done by issuing commands from the host equipment.

Command	Parameter 1	Parameter 2~7	Function
GU	Address	not used ※	Obtain setting information
SU	Address	Parameter	Change of camera settings
INIT	not used	not used	Restore to factory settings
SAVE	not used	not used	Save the camera settings

※ Basically, there is no parameter. Please refer to the [Section 5.2.](#) for the details.

[Note]

Several seconds are needed to save the data to EEPROM after SAVE command is issued.

Do not turn OFF the camera power until the returned value (>) is responded.

If not, the camera may operate abnormally when it is rebooted next time.

(3) How to set a command

{Command Name} {Parameter 1} {Parameter 2} {Parameter 3}...

- Input of {Parameter n}
 - In case of Hexadecimal number:
Start from "0x" or "0X"
Either capital letters or lower case can be input. (a~f, A~F are both acceptable).
Input range: 0x0000~0xFFFF
 - In case of Decimal number:
Only '0'~'9' are acceptable.
Input range: 0~65535 (Baud rate parameter is the exception and 115200 can be input).
- At starting-up, prompt ">" is indicated after command is processed.
- Commands shall be input with capital letters following to prompt.
- Up to eighty letters can be input.
- Commands and parameters shall be separated by spaces.
- From the head of the input letter to the line feed code, CR (0x0d) or LF (0x0a), is defined as a command.
- Refer to the [Section 5.2. Function Settings](#), for the details on address and data settings.
- The sent command is echoed back after it was received.

【Example of Get Command】

To get the information of the Command No. 40.

[Send]	GU[sp]40[¥r] or[¥n]	
[Returned value]	4[¥r] [¥n]	[Acquired data + Linefeed]
[Returned value]	[¥r] [¥n]	[Linefeed]
[Returned value]	>[sp]	[Prompt + Space]

【Example of Set Command】

To set 5 to the Command No. 40.

[Send]	SU[sp]40[sp]5[¥r]or[¥n]	
[Returned value]	[¥r] [¥n]	[Linefeed]
[Returned value]	>[sp]	[Prompt + Space]

【Example of SAVE Command】

[Send]	SAVE[¥r]or[¥n]	
[Returned value]	[¥r] [¥n]	[Linefeed]
[Returned value]	>[sp]	[Prompt + Space]

※SAVE Command is equivalent to SU 5.

[¥r]=CR(0x0D)

[¥n]=LF(0x0A)

[sp]=Space(0x20)

Aegis Electronic Group
www.aegiselect.com

5.2. Function Settings

Function	Address	Data	Explanation
Factory settings 【Write Only】	0	None	Restore to the factory settings. User registered defective pixels and user data settings (SU 1000) shall not be restored.
Data Save 【Write Only】	5	None	Save the camera settings. Several seconds are needed after SAVE command is issued and the data is actually saved to EEPROM. Do not turn OFF camera power until the returned value (>) is responded.
Camera operational error register 【Read-only】	10	1- 2 Parameters	(0:Normal, 1:Error in PoCL power supply, 2: Error with inappropriate triggers)
Black out with errors in camera operation	11	0	OFF, Black out the output image when an error is detected in camera operation.
		1	ON 【Factory setting】
Serial communication Baud rate	20	※ It is not restored by INIT command (SU 0). Baud rate change is reflected when the camera is booted up next time.	
		9600	9,600 baud 【Factory setting】
		115200	115,200 baud
Version information 【Read-only】	21	None	Indicates the revision information on firmware and hardware.
System information 【Read-only】	22	1 Parameter	0: Camera model name information 1: Camera serial number information
CMOS Sensor reset 【Write Only】	29	2	Rest CMOS sensor.
Output bit length and Tap width	40	4	8Tap 8bit Output CLK:72MHz 21.54fps Factory setting】
		5	8Tap 8bit output CLK:85MHz 24.95fps
		6	10Tap 8bit Output CLK:85MHz 31.96fps
Camera operational mode	41	0	Full frame scan (5120 pixels x 5120 Lines fixed) 【Factory setting】
		1	Custom ROI
		2	Not available
		3	Multiple ROI
		4	Sequence Control mode
		※Custom ROI, Multiple ROI, and Sequence mode cannot be set at the same time.	
Trigger shutter mode	51	0	Normal shutter mode (Trigger shutter mode OFF) (Shutter speed can be set with the Address 110 and 111) 【Factory setting】
		1	Fixed Trigger shutter mode (Shutter speed can be set with the Address 110 and 111)
		2	Pulse Width trigger shutter mode (Shutter speed can be set with trigger pulse width)
Trigger polarity	52	0	Positive 【Factory setting】
		1	Negative
Trigger input selection	53	0	Camera Link CC1 【Factory setting】
		1	12pins circular connector No. 11 pin (TTL)

Function	Address	Data	Explanation
Preset Gain	100	0	0dB 【Factory setting】
		1	+6dB
		2	+12dB
		3	+18dB
		15	Manual gain (Refer to the Address 101)
Manual Gain	101	0 ~ 1800	0 ~ +18dB (Can be set per 0.25dB)
Preset Shutter	110	0 ~ 7	Preset control (Refer to the Section 5.2.1 for preset shutter) 【Factory setting=0】
		15	Manual control (Refer to the Address 111.)
Manual Shutter	111	30~31250	Can be set per 1us ※The maximum value varies depending on ROI settings.
White Balance Select	140	0	OFF
		1	Manual
		2	One Push
One Push Start 【WriteOnly】	141		One Push start trigger
Manual R Balance	143	0~800	Setting value of Manual R (0 ~ 800%) 【Factory setting 100】
Manual B Balance	145	0~800	Setting value of Manual B (0 ~ 800%) 【Factory setting 100】
Current R Balance	153	None	Indicates R balance value in execution. (0 ~ 800%)
Current B Balance	155	None	Indicates B balance value in execution. (0 ~ 800%)
Gamma Correction	200	0	Gamma correction OFF 【Factory setting】
		1	Gamma correction ON
Gamma Selection	201	0	User customizing (Initial value 0.45) 【Factory setting】
		1	0.45
User Customizing Gamma Table	202	2 parameters	The 1 st Parameter: The address of the gamma table (0~256) The 2 nd Parameter: Output level (0~1024)
Black Level Adjustment	250	0~255	Sensor Black level 【Factory setting = 10】
Shutter Line effect	251	0	Effect A
		1	Effect B 【Factory setting】
Custom ROI Settings			
Custom ROI Setting Parameter Set	401	4 parameters	The 1 st Parameter: Horizontal start pixel (0~5056 per 64 pixels) The 2 nd Parameter: Vertical start line (0~5118 per 2 lines) The 3 rd Parameter: Horizontal effective pixels (64~5120 per 64 pixels) The 4 th Parameter: Vertical effective lines (2~5120 per 2 lines)

Multiple ROI Settings			
Execution of Multiple ROI 【Write Only】	408		Valid Multiple ROI settings
Multiple ROI Parameter Set	409	5 Parameters (1 parameter when acquired.)	The 1 st Parameter: Multiple ROI Parameter number (0~31) The 2 nd Parameter: Horizontal start pixel (0~4992 per 128 pixels) The 3 rd Parameter: Vertical start line (0~5118 per 2 lines) The 4 th Parameter: Horizontal effective pixels (128~5120 per 128 pixels) The 5 th Parameter: Vertical effective lines (2~5120 per 2 lines) ※The same values shall be set for the 4th parameter (Horizontal effective pixels).
Valid Multiple ROI	410	2 Parameters (1 parameter when acquired.)	The 1 st Parameter: Multiple ROI parameter number (0~31) The 2 nd Parameter: Valid setting (0:Invalid 1:Valid)
Sequence Control Mode Settings			
Sequence Control	500	0	Sequence Control mode OFF/STOP
		1	Burst mode edge start
		2	Burst mode level start
		3	Burst mode soft start
		4	Step mode 1 Index parameter control
		5	Step mode 1 CC2~4 parameter control
		6	Step mode 2 Pulse width trigger Index parameter control
		7	Step mode 2 Pulse width trigger CC2~4 parameter control
Sequence Index range	501	0 ~ 7	
Sequence Index	502	2 Parameters (1 parameter when acquired)	The 1 st Parameter: index number (0 ~ 7) The 2 nd Parameter: Parameter set number (0 ~ 7)
Sequence Index Repeat Count	503	2 Parameters (1 parameter when acquired)	The 1 st Parameter: Index number (0 ~ 7) The 2 nd Parameter: Sequence Index repeat count (1 ~ 1023)
Sequence Loop Count	504	0 ~ 1023	Loop Count of entire sequence (0: infinity 1~1023: Loop count)
Sequence Parameter set	505	7 Parameters (1 parameter when acquired)	The 1 st Parameter: Sequence parameter number (0~7) The 2 nd Parameter: Shutter (Setting range is the same as the Address 111.) The 3 rd Parameter: Gain (Setting range is the same as the Address 101.) The 4 th Parameter: Horizontal start pixel (0~5056 per 64 pixels) The 5 th Parameter: Vertical start line (0~5118 per 2 lines) The 6 th Parameter: Horizontal effective pixels (64~5120 per 64 pixels) The 7 th Parameter: Vertical effective lines (2~5120 per 2 lines)
Sequence Status Image output	506	0	OFF 【Factory setting】
		1	ON
Sequence Status Read 【Read-only】	507	3 Parameters	The 1 st Parameter: The current Index number (0~7) The 2 nd Parameter: Repeating count of the current Index (1~1023) The 3 rd Parameter: The current Loop number (1~1023)

Function	Address	Data	Explanation
Test Pattern output	900	0	OFF 【Factory setting】
		1	Color bar (Still)
		2	Color bar (Movie)
Shading correction	906	0	OFF 【Factory setting】
		1	ON
Shading detection 【Write Only】	907	None	Start calculating the shading correction table.
Shading correction table selection	908	0 ~ 2	Select the shading correction table.
Defective pixel correction	910	0	OFF
		1	ON 【Factory setting】
White spot detection by the user	911	2 Parameters (None at acquiring)	The 1 st Parameter: Threshold (0 ~ 1023) The 2 nd Parameter: 0: Re-capturing 1: Additional capturing Users can detect white spots caused later. When capturing, it responds how many spots were detected. It shall not be restored by INIT command (SU 0).
Entire deletion of the defective pixels registered by the user. 【Write Only】	914	None	Deletes all the defective pixels detected and registered by the user.
Indication of the defective pixels	915	0 at setting	Turn OFF bright spot indication function.
		1 at setting	Indicates the position of the defective pixels as a bright spot while correcting the pixels. ※Bright spot is not shown when correction function is OFF.
		1 at capturing	Indicates all the list of ex-factory data and the registered data by the user.
		2 at capturing	Indicates the list of the registered data only by the user.
		3 at capturing	Indicates the number of the registered defective pixels in the indication area per strip.
		4 at capturing	List the registered defective pixels by the user in the indication area per strip.
		5 at capturing	Indication of the status.
Cursor Indication	918	0	OFF 【Factory setting】
		1	ON
Cursor Coordinate	919	2 Parameters	The 1 st Parameter: Horizontal cursor position (0 ~ 5119) The 2 nd Parameter: Vertical cursor position (0 ~ 5119) (Preset value is the center coordinate)
CMOS Sensor Temperature 【Read-only】	930		Indicates the temperature register value of the camera CMOS sensor.
User Data settings	1000	Parameter 1 (None at acquiring)	Set any letter strings in the user area. The minimum of one letter and the maximum of thirty letters can be set in the letter string. Save settings with SAVE command (SU 5). 【Factory setting = non letter string】 It shall not be restored by the INIT command (SU 0).

5.2.1 The List of Preset Shutter

Setting value	Common in all output modes [Unit:s]
0	1/32
1	1/50
2	1/100
3	1/200
4	1/500
5	1/1000
6	1/10000
7	1/30000
15	Manual

- ※ Actual exposure time and the set values of shutter time are different depending on the cases. It is different in case of when exposure starts while reading out, and in case of when exposure does not start while reading out. Please refer to the chart of Exposure Time Delay for the details in the [Section 4.4](#).
- ※ When the preset shutter time becomes bigger than its frame rate, it shall be clipped to the exposure time for that frame rate automatically.

5.2.2 Functions Unable to Set at the Same Time

Operational Mode	Defective pixels correction	Shading correction	Test pattern or Cursor indication	Detection of defects by the user	Shading detection	White Balance One Push	White Balance
Full size (5120x5120)	○	○	○	○	○	○	○
Custom ROI	○	○	○	×	×	○	○
Sequence	×	○	○	×	×	×	○
Multiple ROI	×	×	○	×	×	×	○

When test pattern indication is ON, user white defect detection, shading detection, and white balance one push start cannot be performed.

6. Dimensions

6.1. Camera Dimensions

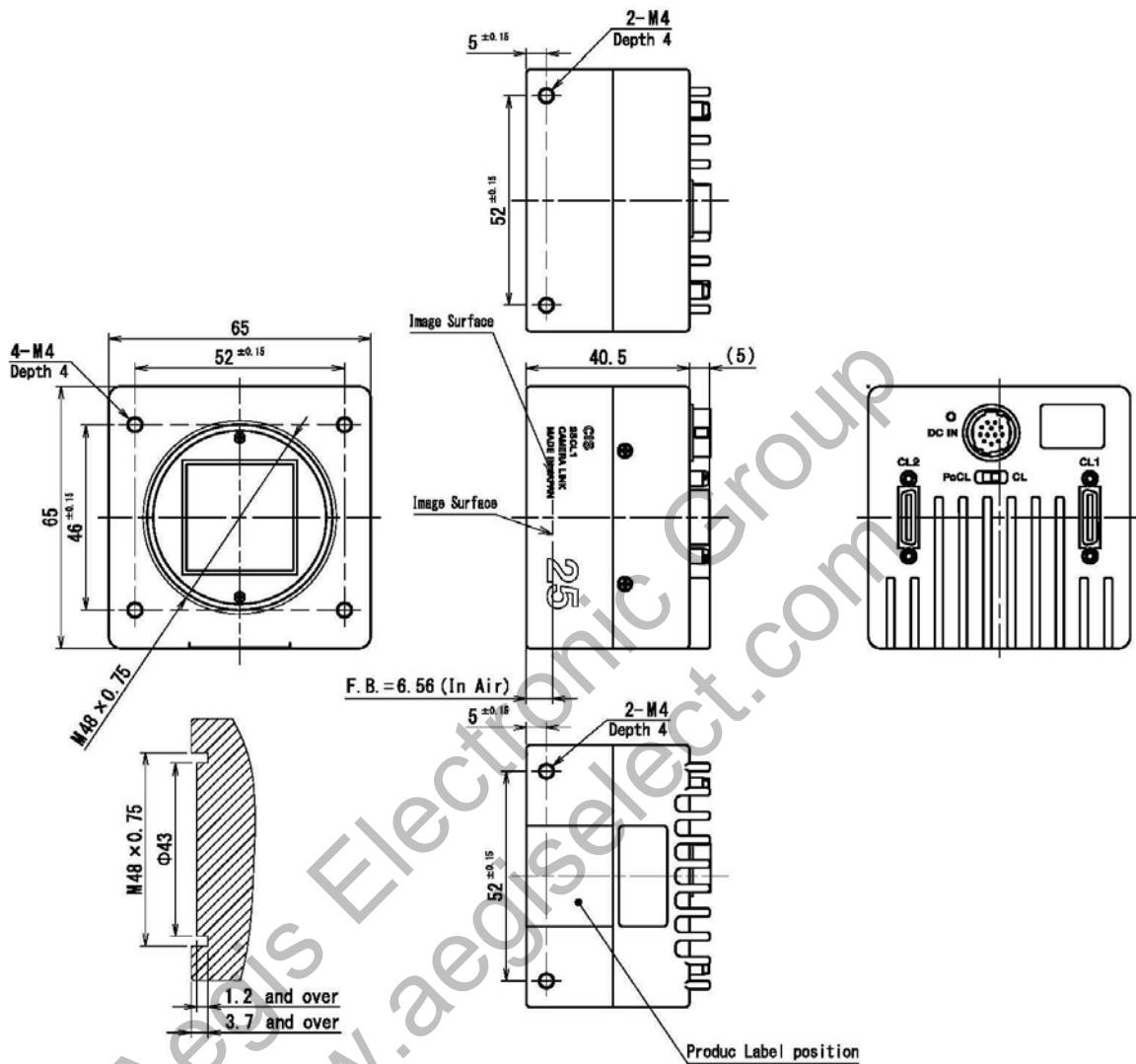

Note 2) Lens mount screw complies with M48 × 0.75-6H. Please refer to JIIA LE-004-2011.
 Note 1) Please make sure the protrusion portion does not interfere with the lens selected.
 Refer to the lens mount cross-section diagram for the details.

935-0063-00
 (Unit:mm)

6.2. Optical Axis Accuracy

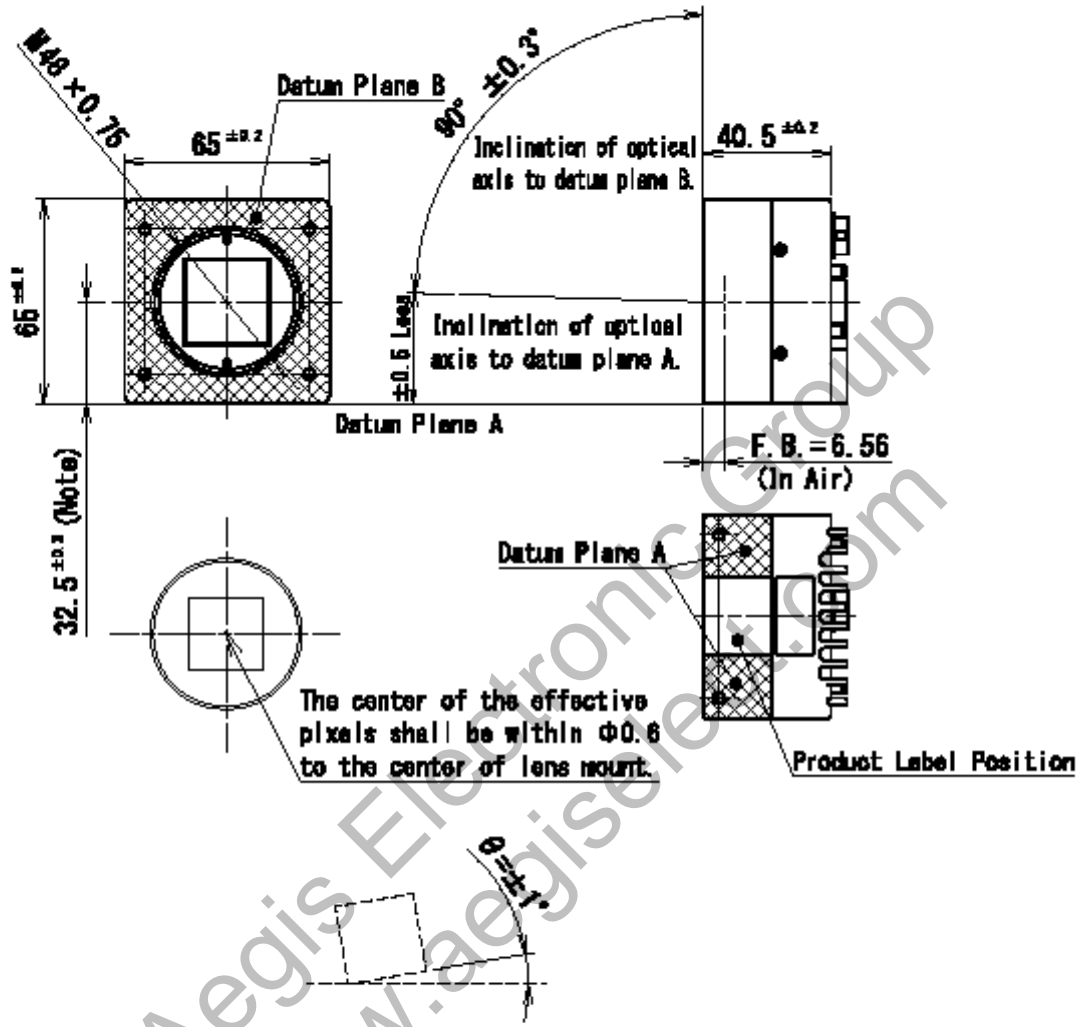

Inclination of the effective pixels θ to the datum plane A is $\theta \leq \pm 1^\circ$

Note : Dimensions from datum plane A to the center of the lens mount.

937-0017-00
(Unit:mm)

7. Case for Indemnity (Limited Warranty)

7.1. Product Warranty

The term of warranty of this product is within 3 years from the date of shipping out from our factory.

If you use the product properly and discover a defect during the warranty period, and if that was caused by designing or manufacturing, CIS Corporation, at its option, repairs or replaces it at no charge to you. Products out of warranty period will be subject to charge. CIS repairs the products as long as it is repairable.

CIS shall be exempted from taking responsibility and held harmless for damages or losses incurred by the following cases.

- In case damages or losses are caused by earthquake, lightning strike, fire, flood, or other acts of God.
- In case damages or losses are caused by deliberate or accidental misuse by the user, or failure to observe the information contained in the instructions in this Product Specification and Operational Manual.
- In case damages or losses are caused by repair or modification conducted by the customer or any unauthorized party.

7.2. CMOS Pixel Defects

CIS compensates the noticeable CMOS pixel defects found at the shipping inspection prior to our shipment. On very rare occasions, however, CMOS pixel defects might be noted with time of usage of the products. Cause of the CMOS pixel defect is the characteristic phenomenon of CMOS sensor itself and CIS is exempted from taking any responsibilities for them. Should you have any questions on CMOS pixel defects compensation please contact us.

8. Supplementary Note

8.1. Product Support

Should you have any problems in function of the product you purchased, and if you need our further analysis and/or repair, please contact the dealer you purchased it from.