

# CIS

Camera Link I/F  
CMOS MV Camera

# VCC-SXCL5R

**Product Specifications**  
**& Operational Manual**

**CIS Corporation**

## Table of Contents

1.	Handling Precautions .....	1
1.1.	Camera Handling Precautions .....	1
1.2.	Restrictions on Applications .....	1
1.3.	Disclaimers (Exception Clause) .....	1
1.4.	Precautions on Exporting .....	2
2.	Product Outline .....	2
2.1.	Features .....	2
2.2.	System Configuration .....	2
3.	Specifications .....	3
3.1.	General Specifications .....	3
3.2.	Camera Input and Output Signals Specifications .....	5
3.2.1	No. 4 and No. 5 pin of 6pins Circular Connector: Trigger Photo Coupler Insulation Input .....	5
3.2.2	No. 3 pin of 6pins Circular Connector: Exposure Output .....	5
3.3.	External Connector Pin Assignment .....	5
3.3.1	6pins Circular Connector HR10-7R-6PA (HIROSE) or equivalent .....	5
3.3.2	Camera Link Connector 12226-1100-00PL (SUMITOMO 3M) .....	6
3.3.3	LED Indicator .....	6
3.4.	CMOS Spectral Response .....	6
3.5.	Output Data Configuration .....	7
3.6.	Video Output Format .....	8
3.7.	Timing Chart .....	9
3.7.1	Horizontal Synchronous Timing .....	9
3.7.2	Vertical Synchronous Timing .....	10
4.	Camera Operational Specifications .....	11
4.1.	Camera Operational Mode .....	11
4.1.1	ROI (Region of Interest) Mode .....	12
4.2.	Gain Settings .....	13
4.3.	Settings of Exposure Time .....	13
4.4.	Shutter Mode .....	14
4.4.1	Continuous Reading out Shutter Mode .....	15
4.4.2	Fixed Trigger Shutter Mode .....	15
4.4.3	Pulse Width Trigger Shutter Mode .....	16
4.5.	White Balance .....	16
4.5.1	One Push Start .....	17
4.5.2	One Push Detecting Range .....	17
4.6.	Shading Correction .....	18
4.6.1	Detect Shading Correction Data .....	18
4.7.	Black Level Adjustment .....	18
4.8.	Test Pattern Indication .....	19
4.9.	Cursor Indication .....	19
4.10.	Horizontal Flip and Vertical Flip .....	19
4.11.	Defective Pixels Correction Function .....	20
4.12.	User Data Save / Readout Function .....	23
4.12.1	User Data Save .....	24
4.12.2	Users Data Readout .....	24
4.13.	Reset .....	24
5.	Remote Communication Function .....	24
5.1.	Serial Communication .....	24

- 5.2. Function Settings ..... 26
  - 5.2.1 The List of Preset Shutter ..... 30
  - 5.2.2 Calculating Exposure Time ..... 30
  - 5.2.3 Functions Unable to Set at the Same Time ..... 31
- 6. Dimensions ..... 32
  - 6.1. Camera Dimensions ..... 32
  - 6.2. Optical Axis Accuracy ..... 33
- 7. Case for Indemnity ..... 34
  - 7.1. Product Warranty ..... 34
  - 7.2. CMOS Pixel Defects ..... 34
- 8. Supplementary Note ..... 34
  - 8.1. Ordering Information ..... 34
  - 8.2. Product Support ..... 34

Aegis Electronic Group  
www.aegiselect.com

## 1. Handling Precautions

### 1.1. Camera Handling Precautions

- Do not use or store the camera in the extremely dusty or humid places.
- Do not apply excessive force or static electricity that could damage the camera. Handle the camera with care.
- Do not shoot direct images that are extremely bright (e.g., strong light source, sun, etc.). When strong light such as spot light was shed, blooming or smear may occur. Put the lens cap on when camera is not in use.
- Follow the instructions in the [Section 3.3., "External Connector Pin Assignment"](#) for connecting the camera. Improper connection may cause damages not only to the camera but also to the connected devices.
- Confirm the mutual ground potential carefully before connecting the camera to monitors or computers. Any AC leaks or coupling noises from the connected devices may cause damages or destroy the camera.
- Do not apply excessive voltage. Use only the specified voltage. Unstable or improper power supply voltage may cause damages or malfunction of the camera.
- The voltage ripple of camera power DC +12V±10% shall be within ±50mV. Improper power supply voltage may cause noises on the video signals.
- The rising time of camera power supply voltage shall be less than +10V, Max 60ms. Please avoid noises like chattering when rising.

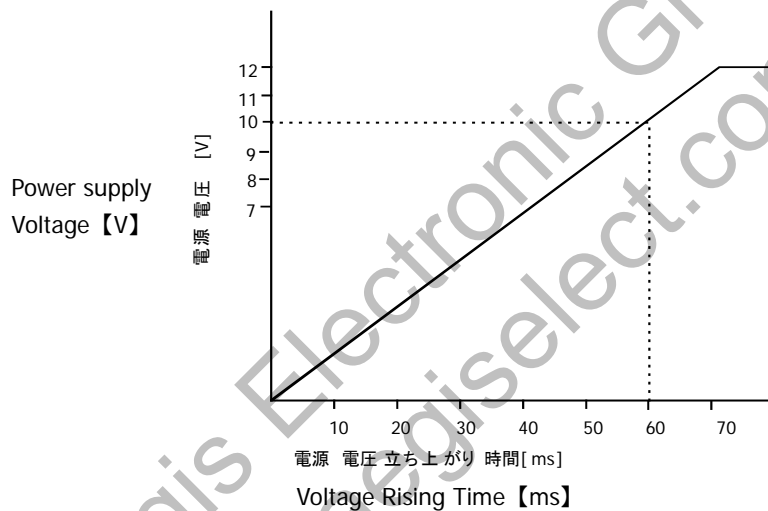

- Our warranty does not apply to damages or malfunctions caused by neglecting these precautions.

### 1.2. Restrictions on Applications

- The camera must not be used for any nuclear equipment or aerospace equipment with which mechanical failure or malfunction could result in serious bodily injury or loss of human life. Our warranty does not apply to damages or defects caused by irregular and/or abnormal use of the product.
- The camera must not be used under conditions or environments other than specified in this manual.

### 1.3. Disclaimers (Exception Clause)

CIS shall be exempted from taking responsibility and held harmless for damages or losses incurred by the following cases.

- In case, damages or losses are caused by earthquake, lightning strike, fire, flood, or other acts of God.
- In case, damages or losses are caused by deliberate or accidental misuse by the user, or failure to observe the information contained in the instructions in this Product Specification and Operational Manual.
- In case, damages or losses are caused by repair or modification conducted by the customer or any unauthorized party.

#### 1.4. Precautions on Exporting

- When exporting our products, fully follow administrative regulations, such as “Export Trade Control Order”, “Foreign Exchange Control Order”, and “Catch-All Controls”, and carefully research on your end customer and its applications to classify and determine if it is appropriate to export.
  - ※ Refer to the METI web (Ministry of Economy, Trade and Industry) for the details.  
<http://www.meti.go.jp/policy/anpo/englishpage.html>

## 2. Product Outline

VCC-SXCL5R is a Camera Link interfaced, and SXGA resolution industrial color camera module. 1.5M pixels, 1/2.9 type CMOS sensor is utilized. 29mm cubic in size with high-speed capability of 135.7fps, yet cost effective camera.

### 2.1. Features

- Global Shutter type CMOS sensor
- Camera Link 1tap/2tap/3tap selection, output clock selection, output bit length selection
- Trigger shutter mode: Fixed trigger shutter mode / Pulse width trigger shutter mode
- High frame rate (135.7fps at entire pixels)
- One push white balance function
- Shading correction
- Defective pixels correction by users
- 29mm cubic in size
- ROI function

### 2.2. System Configuration

- Camera
  - ◆ Camera VCC-SXCL5R
- Free Software
  - ◆ CIS control panel software for evaluation purpose only is downloadable via our web. CIS shall be exempted from taking responsibility and held harmless for damages or malfunction of your hardware and software caused by using this control software. The purpose of this control software prepared is for users to check operation and evaluate our products. Please be noted that CIS does not customize the program nor provide source code.
- Packaging
  - ◆ Individual carton
  - ◆ Sub-carton (10pcs/carton), Master carton (100pcs/carton)

Note) Cartons may vary depends on the quantity to be shipped.

## 3. Specifications

## 3.1. General Specifications

<b>Electrical Specifications</b>			
Pick up device	Device type	1/2.9 type SXGA pixels, Global shutter type CMOS IMX273	
	Effective pixel number	1456(H) x 1088(V) Recommended pixels: 1440(H) x 1080(V)	
	Unit cell size	3.45 $\mu$ m(H) x 3.45 $\mu$ m(V)	
	Chip size	5.02mm x 3.82mm Diagonal length: 6.3mm	
Video output mode		PoCL/non-PoCL Base Configuration Model digital 8/10/12bit (2Tap), 8bit (1Tap, 3Tap) Camera Link Version 1.2 complied (Initial settings: 2Tap/8bit Base Configuration)	
Video output clock number (Continuous reading out, Full frame)	1Tap (8bit)	Horizontal clock number: 1444clk	
	2Tap (8bit/10bit/12bit)	Horizontal clock number: 724clk	
	3Tap (8bit)	Horizontal clock number: 484clk	
		Vertical scan line number: 1130 lines (For all Tap)	
Frame rate (Continuous reading out, Full frame)	Pixel clock frequency	74.25MHz	64.969MHz 37.125MHz
	1Tap 8bit	45.50fps	39.77fps 22.75fps
	2Tap 8/10/12bit	90.75fps	79.35fps 45.37fps
	3Tap 8bit	135.76fps	118.60fps 67.88fps
Sync. system		Internal Sync. System	
Resolution (The maximum pixel size)		1440(H) x 1080(V)	
Video signals (Gain 0dB)	White clip level	FFh	At 8bit output
	Set up level	08h $\pm$ 02h	At 8bit output, Gain 0dB
	Dark shading	Under 04h for both Horizontal and vertical.	At 8bit output, Gain 0dB
Sensitivity		12bit Mode F4 2000lx 3200K 1/95s (Exposure time for Default setting) 8bit Mode F8 2000lx 3200K 1/95s (Exposure time for Default setting)	
Minimum illumination		12bit Mode 3.0 (F1.4, Gain42dB, Shutter: 1/95s) 8bit Mode 0.80 (F1.4, Gain42dB, Shutter: 1/95s)	
Gain variable range		0dB ~ +42dB (x1 ~ approx. x128)	
Shutter speed		1/24s ~ 1/50000s	
Trigger shutter mode		Fixed shutter trigger mode, Pulse width shutter trigger mode	
ROI		Vertical: 4 ~ 1080 lines (4 lines/step) Horizontal: At 8bit output 516 ~ 1440 pixels (12pixels/step) At 12bit output 264 ~ 1440 pixels (12pixels/step)	
Remote communication		115200/9600 baud selectable, data 8bit, Stop bit 1bit, No parity, XON/OFF invalid	
Power requirements		6 pins circular connector or PoCL (Auto selection) 6pin: 10.5 ~ 15V PoCL: 12V	
Power consumption		2.2W	

<b>Mechanical Specifications</b>			
Dimensions	H:29mm W:29mm D:29mm (without protruding portion) Refer to the <a href="#">Section 6.1. Camera Dimensions</a>		
Weight	Approx. 42g		
Lens mount	C-mount Flange back: 17.526mm Refer to the <a href="#">Section 6.1. Camera Dimensions</a>		
Optical axis accuracy	Refer to the <a href="#">Section 6.2. CMOS Optical Axis Accuracy</a>		
<b>Environmental Specifications</b>			
Safety/Quality standard	UL: Conform to UL for all materials		
	CE:		
	EMC 2014/30/EU		
	Emission: EN61000-6-4 acquired Immunity: EN61000-6-2:2010 acquired		
RoHS: 2011/65/EU (EU)2015/863 EN50581 (RoHS2)			
Durability	Vibration	Acceleration	: 98m/s <sup>2</sup> (10G)
		Frequency	: 20 ~ 500Hz
		Direction	: X,Y, and Z 3 directions
		Testing time	: 120 min for each direction
	Shock	No malfunction shall be occurred with 980m/s <sup>2</sup> (100G) for ±X,±Y, and ±Z, 6 directions without packaging.	
Operation guaranteed temperature		0 ~ +45°C Humidity 20 ~ 80%RH with no condensation	
Storage temperature		-25 ~ +60°C Humidity 20 ~ 80%RH with no condensation	

[Note]

- The maximum of 5 seconds shall be waited until the camera operates normally after it is powered.

3.2. Camera Input and Output Signals Specifications

3.2.1 No. 4 and No. 5 pin of 6pins Circular Connector: Trigger Photo Coupler Insulation Input

- Trigger input terminal (Refer to TRIG\_IN of the drawing, in the [Section 3.2.2](#)) shall be capable of 10mA~20mA electrical current flow.
- Transmission delay time of photo coupler input/output is the maximum of 1μs for both H→L and L→H.

3.2.2 No. 3 pin of 6pins Circular Connector: Exposure Output

- Use as an open collector.
- EEN\_OUT terminal (EEN\_OUT in the drawing below) needs power (3.3V~20V), and load resistance of (0.5mA~5mA) shall be added.
- Output Exposure signal width + 14[μs] becomes the sensor exposure time.

Example

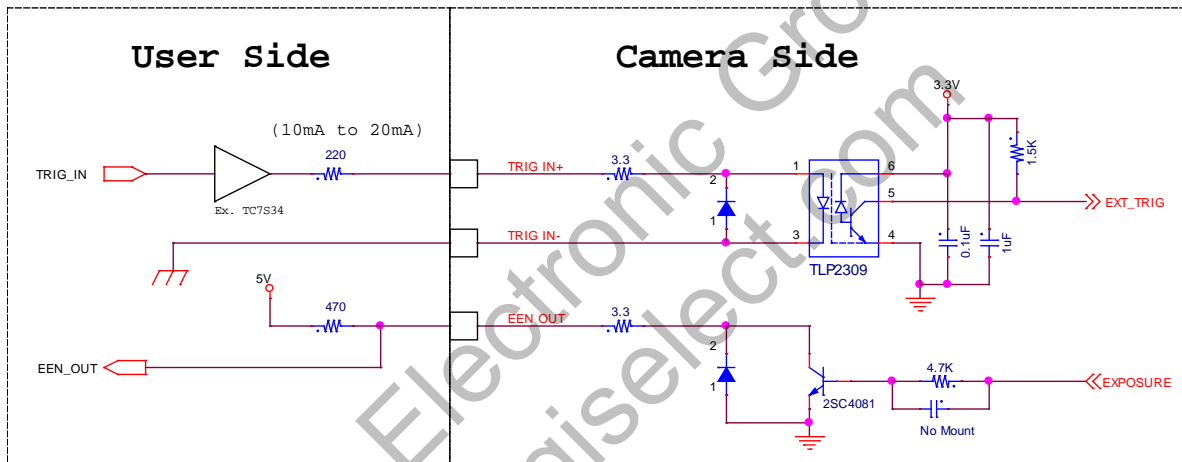

3.3. External Connector Pin Assignment

3.3.1 6pins Circular Connector HR10-7R-6PA (HIROSE) or equivalent

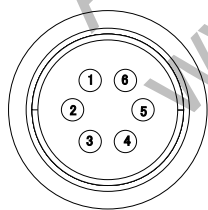

HIROSE  
HR10-7R-6PA or equivalent

Pin No.	Signal Name	Description
1	Power IN	non-PoCL: Power Input (DC 12V typical)
2	NC	Not used
3	EEN_OUT	Exposure Enable Output (Open Collector)
4	Trigger IN-	Trigger Input- (Isolated)
5	Trigger IN+	Trigger Input+ (Isolated)
6	GND	GND (for Pin 1)

## 3.3.2 Camera Link Connector 12226-1100-00PL (SUMITOMO 3M)

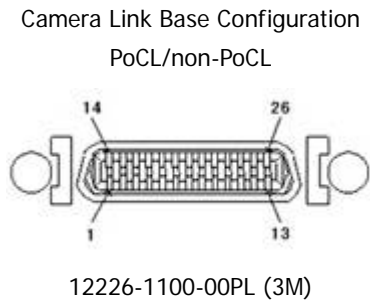

Pin No.	Signal Name	Description
1,26	Power IN or GND	PoCL: DC 12V Power Input non-PoCL: GND
13,14	GND	GND
2,15	X0-, X0+	X0_OUT0 differential pair for transmission
3,16	X1-, X1+	X1_OUT1 differential pair for transmission
4,17	X2-, X2+	X2_OUT2 differential pair for transmission
5,18	Xclk-, Xclk+	CLK OUT differential pair for transmission
6,19	X3-, X3+	X3_OUT3 differential pair for transmission
7,20	SerTC+, SerTC-	RXD Input differential pair for reception
8,21	SerTFC-, SerTFC+	TXD Output differential pair for transmission
9,22	CC1-, CC1+	Trigger Input differential pair for reception
10,23	CC2+, CC2-	Reserve INput differential pair for reception
11,24	CC3-, CC3+	Reserve Input differential pair for reception
12,25	CC4+, CC4-	Reserve Input differential pair for reception

## 3.3.3 LED Indicator

- When the camera is connected and power is supplied, LED is lit up.

## 3.4. CMOS Spectral Response

※ The lens characteristics, IR cut filter characteristics, and illuminant characteristics are excluded.

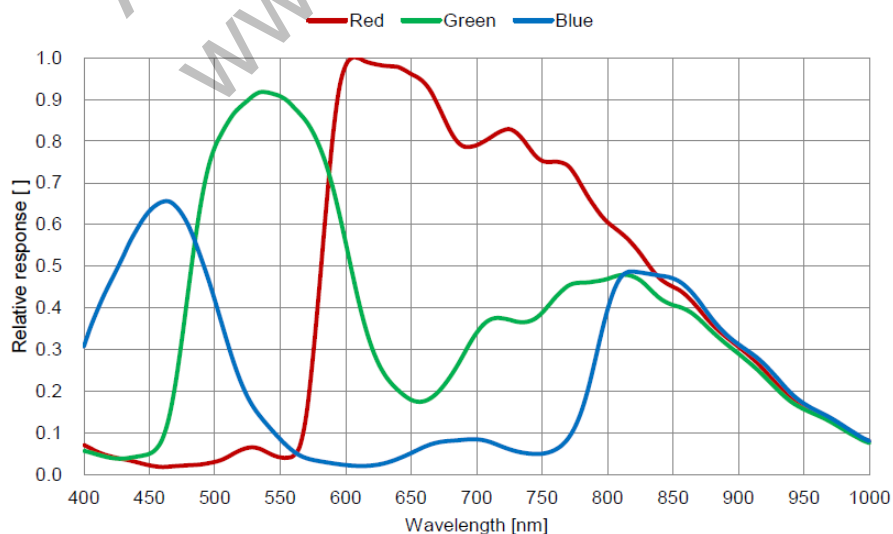

3.5. Output Data Configuration

Port Allocation

Port	8bit Output 1~3Tap	10bit Output 2Tap	12bit Output 2Tap
Port A0	DA[0] LSB	DA[0] LSB	DA[0] LSB
Port A1	DA[1]	DA[1]	DA[1]
Port A2	DA[2]	DA[2]	DA[2]
Port A3	DA[3]	DA[3]	DA[3]
Port A4	DA[4]	DA[4]	DA[4]
Port A5	DA[5]	DA[5]	DA[5]
Port A6	DA[6]	DA[6]	DA[6]
Port A7	DA[7] MSB	DA[7]	DA[7]
Port B0	DB[0] LSB	DA[8]	DA[8]
Port B1	DB[1]	DA[9] MSB	DA[9] MSB
Port B2	DB[2]		DA[10]
Port B3	DB[3]		DA[11]
Port B4	DB[4]	DB[8]	DB[8]
Port B5	DB[5]	DB[9] MSB	DB[9]
Port B6	DB[6]		DB[10]
Port B7	DB[7] MSB		DB[11] MSB
Port C0	DC[0] LSB	DB[0] LSB	DB[0] LSB
Port C1	DC[1]	DB[1]	DB[1]
Port C2	DC[2]	DB[2]	DB[2]
Port C3	DC[3]	DB[3]	DB[3]
Port C4	DC[4]	DB[4]	DB[4]
Port C5	DC[5]	DB[5]	DB[5]
Port C6	DC[6]	DB[6]	DB[6]
Port C7	DC[7] MSB	DB[7]	DB[7]

Output Data Array

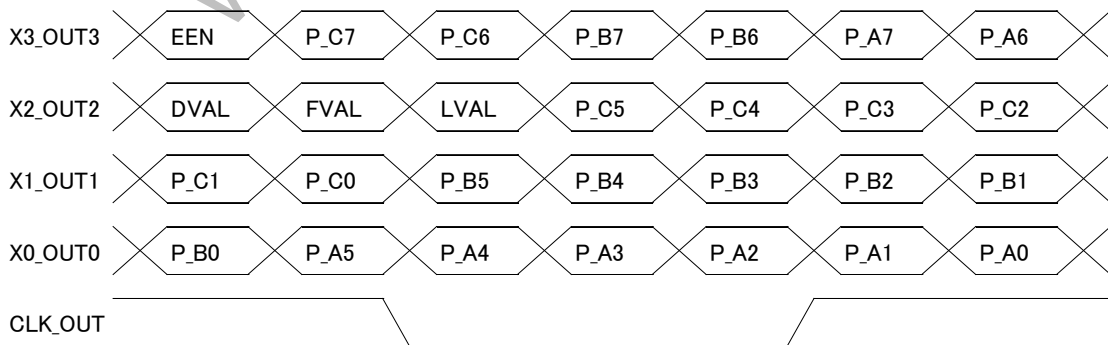

3.6. Video Output Format

Bayer Pattern: RGGB



※ Bayer Pattern flips at output image horizontal flipping.

□ 1Tap Base Configuration mode: At full frame scan output

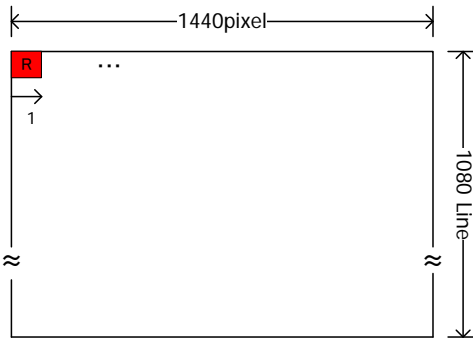

□ 2Tap Base Configuration mode: At full frame scan output (factory setting)

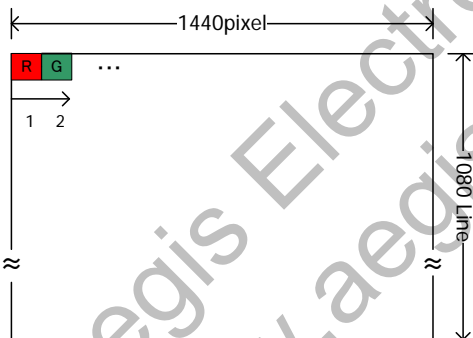

□ 3Tap Base Configuration mode: At full frame scan output

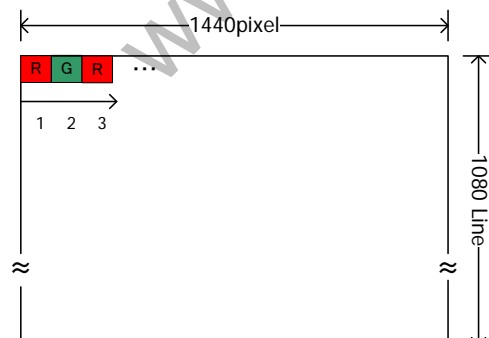

3.7. Timing Chart

3.7.1 Horizontal Synchronous Timing

1Tap Base Configuration mode (Full frame scan):

45.50fps at 74.25MHz      39.77fps at 64.969MHz      22.75fps at 37.125MHz

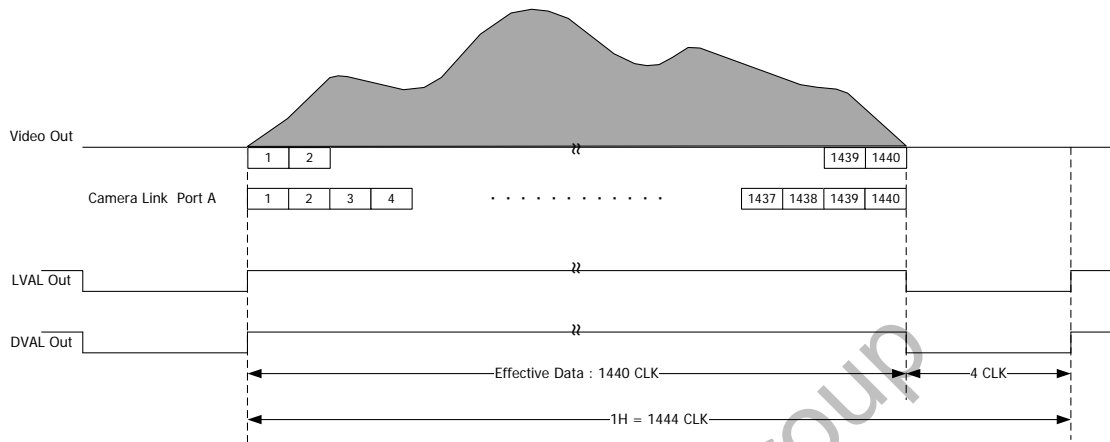

2Tap Base Configuration mode (Full frame scan):

90.75fps at 74.25MHz (Factory setting)      79.35fps at 64.969MHz      45.37fps at 37.125MHz

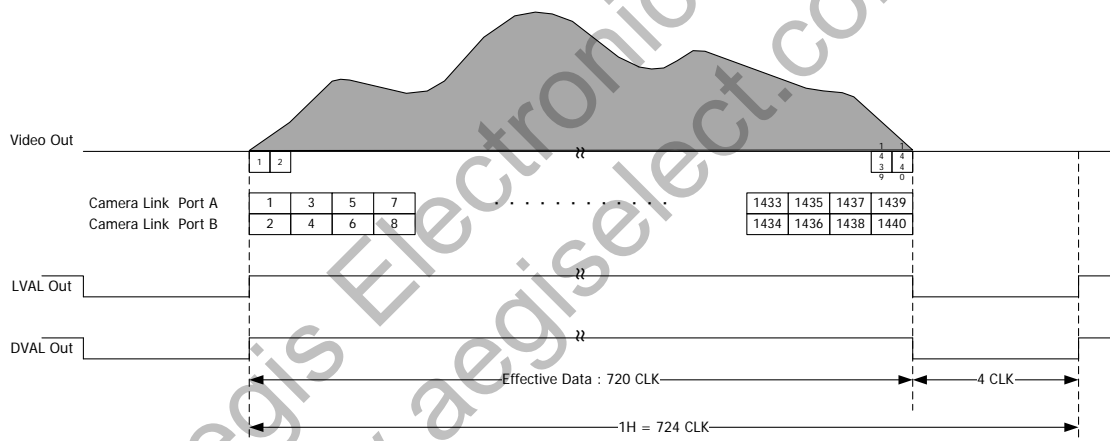

3Tap Base Configuration mode (Full frame scan):

135.76fps at 74.25MHz      118.60fps at 64.969MHz      67.88fps at 37.125MHz

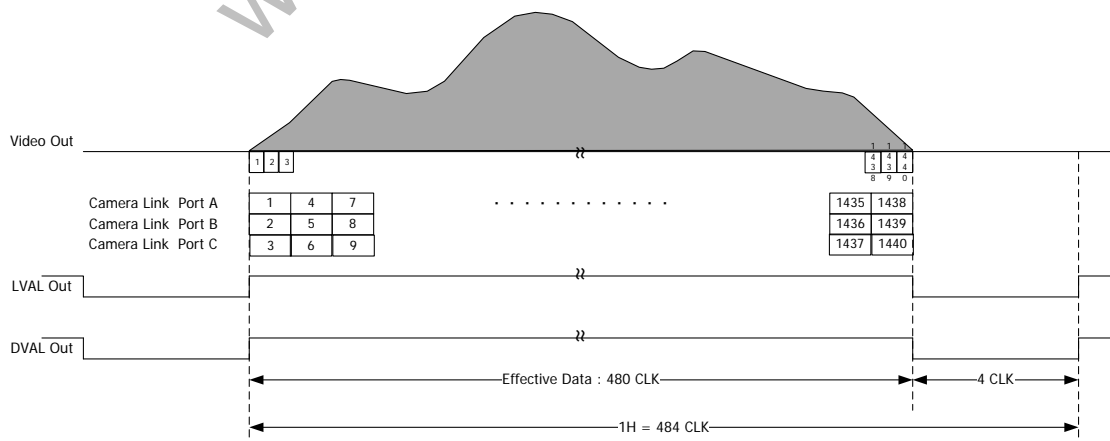

3.7.2 Vertical Synchronous Timing

Continuous readout shutter mode

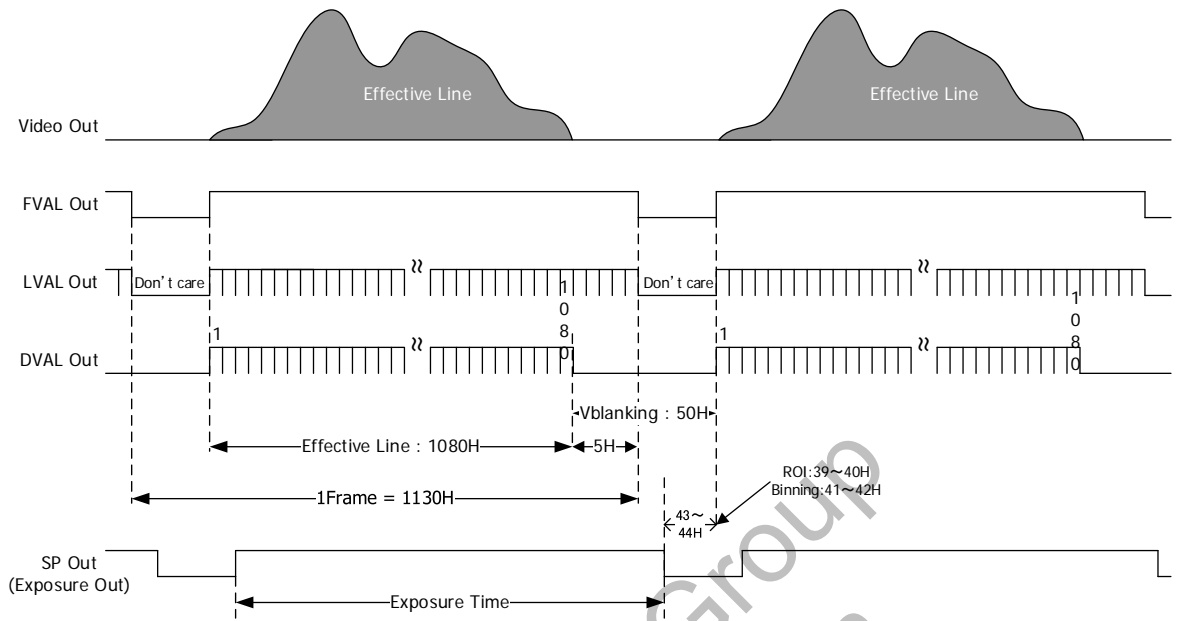

※ Exposure time can be overlapped with readout period.  
 SP OUT (Exposure Out) + 14μs becomes the actual exposure time.

Trigger shutter mode

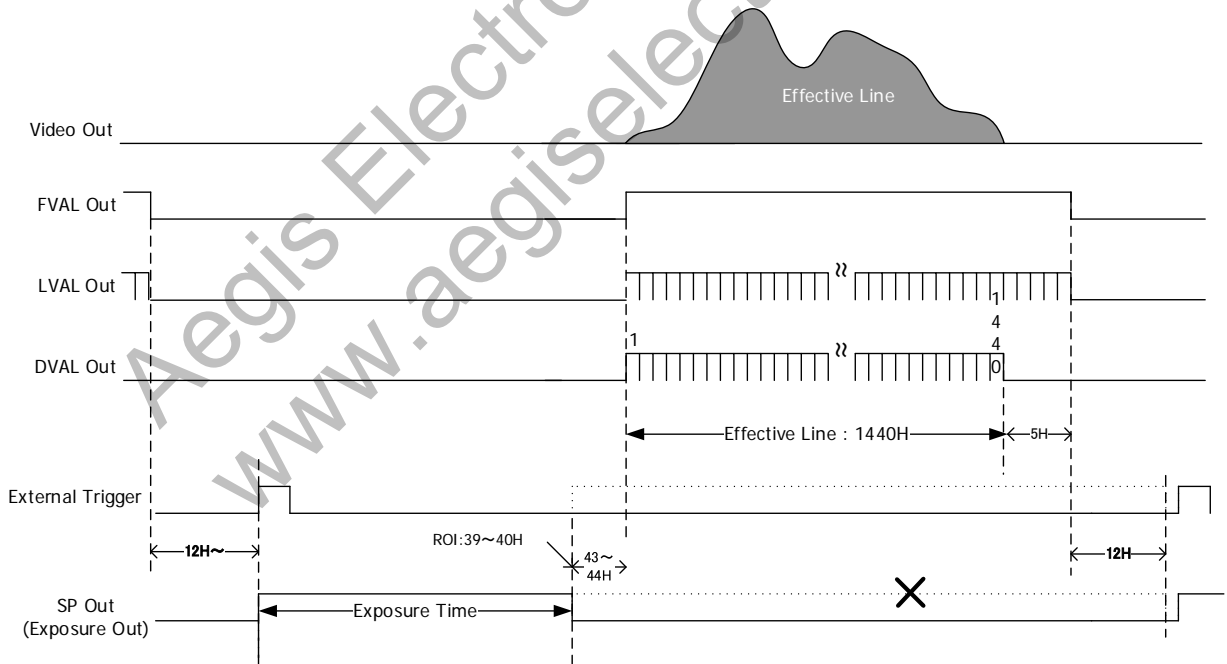

[Note]

- There is a readout period after exposure. Exposure time cannot be started for 12lines after FVAL is fallen, so that frame rate becomes slower than the one for continuous shutter mode.
- SP OUT (Exposure Out) + 14μs becomes the actual exposure time.

4. Camera Operational Specifications

4.1. Camera Operational Mode

Full frame scan (1440 pixels x 1080 Lines fixed) mode and ROI mode are selectable with this camera, VCC-SXCL5R. Both modes cannot be selected at one time. Some function also cannot be selected at the same time.

- Formula to calculate the frame rate at continuous readout shutter mode

Inverse of {Time for 1 line × (vertical effective line count + vertical blanking count)}

Time for 1 line = Clock count for 1 line / 74.25M

The clock count for 1 line shall vary depend on the operational mode

		74.25MHz	64.969MHz	37.125MHz
Clock count for 1 line (74.25MHz)	1Tap 8bit	1444 clk	1652 clk	2888 clk
	2Tap 8bit/10bit/12bit	724 clk	828 clk	1448 clk
	3Tap 8bit	484 clk	554 clk	968 clk

Vertical effective line count is the vertical effective line count of ROI setting parameter set specified by user (Address 401).

Vertical blanking count is fixed to 50.

- ※ Example at 74.25MHz output

ROI range settings	Effective line count H	Frame total line count H	Frame rate (clk count for 1 line) fps		
			1Tap 1444 clk	2Tap 724 clk	3Tap 484 clk
1440 × 1080	1080	1130	45.50 fps	90.75 fps	135.76 fps
1296 × 1024	1024	1074	47.87 fps	95.48 fps	142.83 fps
816 × 600	600	650	79.10 fps	157.77 fps	236.01 fps
648 × 480	480	530	97.01 fps	193.50 fps	289.45 fps

- Formula to calculate the shortest trigger input cycle at trigger shutter mode

Inverse of {Time for 1 line × (vertical effective line count + vertical blanking count) + shutter time}

Common with clock count for 1 line and vertical effective line count at continuous readout shutter mode.

- Vertical blanking count is as follows.

Shutter mode	Operational mode	Vertical blanking count
Continuous readout	Full frame	50 lines
Continuous readout	ROI	50 lines
Trigger	Full frame	62 lines
Trigger	ROI	58 lines

[Note]

- When changing mode settings, synchronization may be jumbled.

## 4.1.1 ROI (Region of Interest) Mode

- This is a mode to make the frame rate faster by cutting and reducing the area to be readout.
  - With the origin (x,y)=(0,0) at the top left corner of the screen at full frame scan mode, the starting coordinate, width, and height are to be specified.
  - ROI Horizontal effective pixels can be specified per 12 pixels.
  - ROI Vertical effective lines can be specified per 4 lines.
  - The start pixel position from the Horizontal left of ROI can be specified per 4 pixels.
  - The start line position from the Vertical top of ROI can be specified per 4 lines.
  - ROI setting values shall be set as follows.

x: Column First Position + w: Column Width  $\leq$  1440

y: Row First Position + h: Row Height  $\leq$  1080

At 8bit output            w: Column Width  $\geq$  516

At 10bit/12bit output    w: Column Width  $\geq$  264

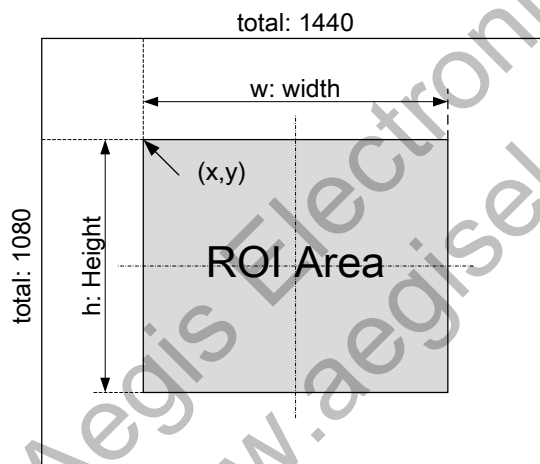

- Regardless of its ROI area, the frame rate of horizontal direction is fixed per TAP, and it changes only by the line number of vertical direction.

- Because the conditions of ROI area for 8bit output and the one for 10bit/12bit output are different, the camera has two different ROI area settings, one for 8bit output and one for 10bit/12bit output. CIS recommends customers to set output bit length and tap width (Address 40) before setting ROI area (Address 401).

## [Note]

- With CIS camera VCC-SXCL5R, horizontal effective pixel number can be set per multiple number of twelve. However, please be noted that there are some cases that effective pixel number is limited per eight pixels instead of multiple of twelve, depending on the Camera Link frame grabber board used. In such case, indefinite data might be shown on horizontal blanking, but it is not an issue for effective pixels.

#### 4.2. Gain Settings

This is to increase video output level by the preset gain or manual gain. Read the current register (Address 104) to know the current gain value.

※ Functionally, gain up function is available up to +42dB. However, it is inevitable that the image quality is reduced when gain setting becomes high. We recommend you to evaluate it first.

##### Preset Gain (Address 100)

Setting Values	Decibel Values
0	0dB
1	6.0dB
2	12.0dB
3	18.0dB
4	24.0dB
5	30.0dB
6	36.0dB
7	42.0dB
15	Manual

##### Manual Gain

Set the above gain registers to manual to set manual gain values.

Any preferred values from 0.0dB to +42.0dB can be set.

※ x 10 equivalent values shall be set.

##### Setting Examples

- In case of when setting +3.2dB with Manual gain.  
SU 100 15  
SU 101 32
- In case of when setting +10.5dB with Manual gain.  
SU 100 15  
SU 101 105

#### 4.3. Settings of Exposure Time

Exposure time can be set. Read the current shutter register (Address 114) to know the current exposure time. (Refer to the [Section 5.2.2. Calculating Exposure Time](#) as well).

There are two kinds of exposure time settings depending on its trigger shutter mode. At continuous reading out shutter mode, input the line number for exposure time. Exposure time settings can be set per line unit. At fixed trigger shutter mode, exposure time can be set per 1 $\mu$ s.

Shutter time [ $\mu$ s] = The time set with the register [ $\mu$ s]+14[ $\mu$ s]. At continuous reading out shutter mode, the shutter time becomes the time for the set line number +14 $\mu$ s. And at fixed trigger shutter mode, the shutter time becomes the set time +14 $\mu$ s.

##### Preset Shutter Mode

This is to use the preset value set in the camera. Please refer to the [Section 5.2.1](#), for the details on the preset values.

□ Manual Shutter Mode

At continuous reading out shutter mode, any preferred exposure time can be set per lines when preset shutter mode is set to manual control. If a bigger value than the frame rate of the image size is set, exposure time shall be clipped automatically with the time for the maximum frame rate for the image size to be used.

At fixed trigger shutter mode, any preferred exposure time can be set when preset shutter mode is set to manual control. Exposure time can be set per  $1\mu\text{s}$ . The minimum exposure time is  $6\mu\text{s}+14\mu\text{s}=20\mu\text{s}$ . And, the maximum exposure time varies depending on its ROI settings and trigger modes. At trigger shutter mode, exposure time would not be clipped and the set exposure time +  $14\mu\text{s}$  is reflected.

[Note]

Clipping of the shutter values at continuous reading out shutter mode.

Shutter values shall be clipped corresponding to its ROI settings, in case of when image output size is set to small size by ROI function and others. (Shutter values are to be clipped with the maximum exposure time of the ROI settings to be used). In such case, the clipped values can be read with the current shutter (Address 114). And, if video output size is changed to bigger size and set back to the original size, the value returns to the preset values.

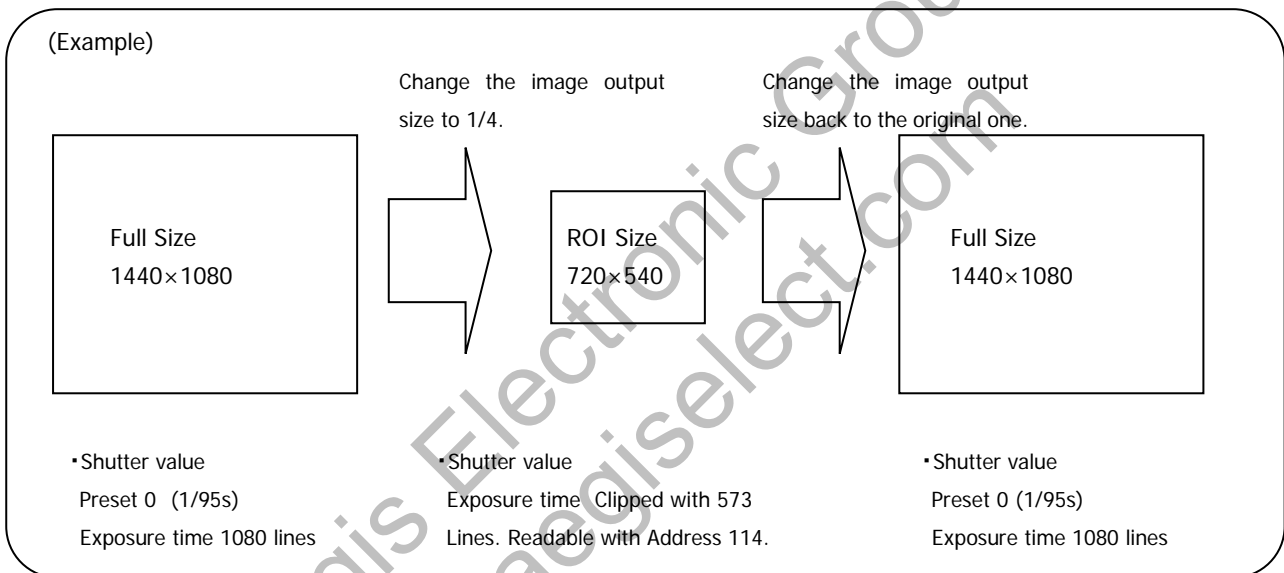

#### 4.4. Shutter Mode

There are three kinds of shutter modes to select, out of continuous reading out shutter mode, fixed trigger shutter mode, and pulse width trigger shutter mode (Address 51). The initial setting is continuous reading out shutter mode.

- No external input trigger is needed for continuous reading out shutter mode so that the camera reads out its video out data continuously by itself.
- At fixed trigger shutter mode and pulse width trigger shutter mode, the camera operates with the external input triggers.
- There are two different kinds of exposure time settings, one for continuous reading out shutter mode and the other for trigger shutter mode. When changing the shutter mode, please check exposure time settings (Address 110 and Address 111) as well.

#### 4.4.1 Continuous Reading out Shutter Mode

- This is a mode to readout video output data continuously. Exposure time can be overlapped to reading out period so that its frame rate becomes faster than the one for trigger shutter mode.
- No external trigger input signal is needed and it operates as free run.
- Exposure time is the preset shutter time (Address 110).
- In case of when changing the reading out cycle with ROI function, and the set exposure time is longer than its frame rate, it shall be clipped with the time for the frame rate automatically.

#### [Note]

- ♦ Exposure time is the latched period per horizontal lines. Exposure time settings (Address 110 and Address 111) are different for continuous reading out shutter mode, and for trigger shutter mode. Therefore, please confirm its exposure time setting as well when changing shutter mode (Address 51).

#### 4.4.2 Fixed Trigger Shutter Mode

- This is a mode to start exposure with external input trigger signals, and set the exposure time with serial commands.
- Trigger operation is CLK Sync. system.

#### [Note]

- ♦ The minimum setting value for fixed trigger shutter mode is 6 $\mu$ s. Shutter time is as below.  
Shutter Time [ $\mu$ s] = The set time with register [ $\mu$ s] + 14[ $\mu$ s].
- ♦ Do not input any trigger signals during video output period. If video reading out period (FVAL=1) and exposure start (the rising edge of exposure time) were overlapped, the camera would stop outputting images.
- ♦ Exposure time can be set per 1 $\mu$ s. There are two different kinds of exposure time settings (Address 110 and Address 111), one for continuous reading out shutter mode and the other for trigger shutter mode. When changing the shutter mode (Address 51), please confirm its exposure time setting as well.
- ♦ The delay time from detecting the trigger edge in the camera to actually starting exposure is the maximum 0.05 $\mu$ s.
- ♦ Please refer to the [Section 3.7.2. Vertical Synchronous Timing](#) for the details on the timing from external pulse input to actual video output.
- ♦ When changing any sync. operation related addresses, such as Reset (Address 29), Out bit length and tap width (Address 40), Camera operational mode (Address 41), Camera Link output clock (Address 49), Shutter mode (Address 51), Trigger polarity (Address 52), Trigger input selection (Address 53), Shutter (Address 110 and 111), and Flipping (Address 902 and 903), CIS recommends you to stop external trigger input once, before changing those.

#### 4.4.3 Pulse Width Trigger Shutter Mode

- This is a mode to start exposure with external input trigger signals, and set the exposure time with pulse width of the trigger signals.
- Trigger operation is CLK Sync. system.
- The delay time from detecting the trigger edge in the camera to actually starting exposure is the maximum 0.05 $\mu$ s. And, the delay time from detecting the trigger completion edge to actually end exposure is the maximum 14 $\mu$ s.

#### [Note]

- Pulse width is 6 $\mu$ s ~ 250ms. Functionally, there is no upper limitation, but at long time exposure, noise increase or decrease of setup level and white clip level could be noticeable.
- Do not input any trigger signals during video output period. If video reading out period (FVAL=1) and exposure start (the rising edge of exposure time) were overlapped, the camera would stop outputting images.
- Please refer to the [Section 3.7.2 Vertical Synchronous Timing](#) for the details on the timing from external pulse input to actual video output.
- When changing any sync. operation related addresses, such as Reset (Address 29), Out bit length and tap width (Address 40), Camera operational mode (Address 41), Camera Link output clock (Address 49), Shutter mode (Address 51), Trigger polarity (Address 52), Trigger input selection (Address 53), Shutter (Address 110 and 111), and Flipping (Address 902 and 903), CIS recommends you to stop external trigger input once, before changing those.

#### 4.5. White Balance

- The following three kinds of modes can be used for White Balance.

0, OFF

Through output without white balance adjustment.

1, Manual

Red and Blue Gain are adjustable with the following commands in the range of 0~800%.

2, OnePush

White balance is adjusted to the output image of when one push start (Address 141) is executed.

[White Balance Gain reference value]

The followings are the reference values of white balance gain for each color temperature.

Color temperature	Manual WB R/B gain	
	R gain (%)	B gain (%)
2800K	126	378
3200K	144	322
4000K	174	257
4500K	189	232
5500K	213	201
6500K	232	182
9000K	264	156

[Note]

- With white balance, minus gain under 100% can be input to R element and B element. Color element with gain under 100% may saturate before the output level reaches 255 (1023 in case of 10 bit output, and 4095 in case of 12 bit output). Therefore, please be careful when using minus gain.

#### 4.5.1 One Push Start

- This is to adjust white balance of the output image.
- Shoot an image with no color to full screen to execute this function. We recommend to execute this function with approx. 50% of signal level.

[Note]

- All R, G, and B color shall not be saturated to execute one push start.
- One push start shall be executed only when the camera is in operation. (One push white balance gain cannot be acquired when camera is not outputting anything.)
- Valid when white balance select (Address 140) is set to 2, OnePush.

#### 4.5.2 One Push Detecting Range

- Detecting range can be specified when executing White Balance One Push.
- With the origin  $(x,y) = (0,0)$  of the output image, the range can be specified by the starting coordinate and size.
- If the starting coordinate plus size exceeds the indication area, it cannot be set.
- Because the ROI setting range for 8bit output and the one for 10bit/12bit output are different, the camera has two different detecting ranges, one for 8bit output and one for 10bit/12bit output. CIS recommends customers to set output bit length and tap width (Address 40) before setting One Push Detecting Range (Address 147).

[Note]

- Detecting range is reset to entire screen when changing camera operational mode and when setting ROI parameter settings at ROI mode.
- Detecting range coordinates are flipped when flipping function is used as well.

#### 4.6. Shading Correction

- This is a function to correct the peripheral brightness lowering caused by the lens and others used.
- Set the shading correction data in advance, then turn ON shading correction (Address 906) to start.

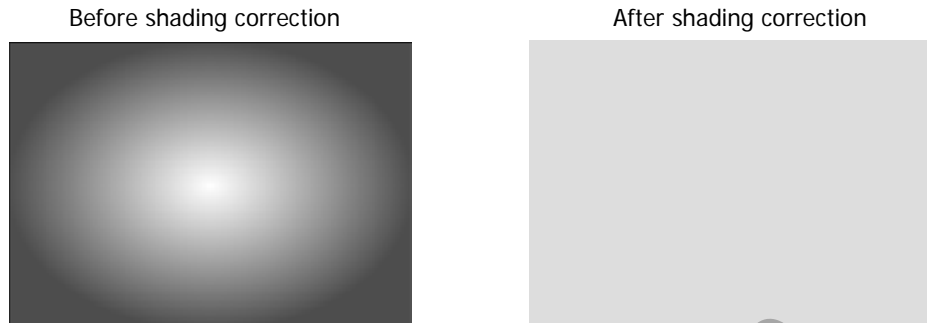

##### 4.6.1 Detect Shading Correction Data

- Shoot a uniform object such as a pattern box, to full screen, and then execute Detect Shading (Address 907), to calculate the correction data automatically in the camera. We recommend detecting shading with medium brightness of output level (128 at 8bit output, 512 at 10bit output, and 2048 at 12bit output). In case of when some area of output level is saturated (255 at 8bit output, 1023 at 10 bit output, and 4095 at 12 bit output), or black (output level 0), proper shading correction data would not be obtained. To save the correction data, execute SAVE (SU 5).

[Note]

- When setting correction data, ROI mode shall be turned OFF. (Set the size to 1440x1080 to execute).
- Shading correction data may not be proper when horizontal flip or vertical flip is performed. In such case, please re-acquire the data.
- Shading correction data can be acquired only when the camera is in operation. (Shading correction data cannot be acquired if the camera is outputting no video).
- When obtain correction data with trigger shutter mode, the data sometimes becomes unstable. In this case, change the trigger cycle in small measure and obtain correction data again.

#### 4.7. Black Level Adjustment

- Black Level is adjustable.

[Note]

- When black level control value is increased or decreased by 1, its black level changes by approx. 1.0 at 12 bit output, by approx. 0.25 at 10 bit output, and it changes by approx.0.0625 at 8bit output.
- Indication of the control value is based on the one at 12 bit output, regardless of its output bit range.

4.8. Test Pattern Indication

- Test pattern can be output from the camera. It is useful to check if your system is operating properly.

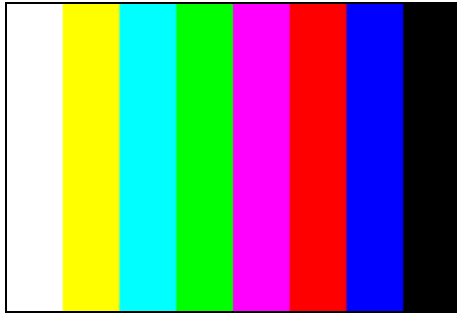

[Note]

- Gain, Shading correction, Defective pixel correction, and Black level adjustment function will be turned OFF automatically.
- This function cannot be set when cursor indication is ON.

4.9. Cursor Indication

- A cursor can be indicated on the screen. Cursor X coordinate specifies the vertical cursor X coordinate, and Cursor Y coordinate indicates the horizontal cursor Y coordinate. The origin,  $(x,y)=(0,0)$ , of the coordinate is the upper left in the indication area and coordinates are the offset from the origin.

[Note]

- This function cannot be set when test pattern indication is ON.
- When changing the settings of camera operational mode, outbit length, and ROI setting parameters, the cursor coordinates, X and Y, shall be reset to the center (Image width/2, Image height/2).

4.10. Horizontal Flip and Vertical Flip

- When using flip function and ROI function at the same time, full frame image is to be flipped. And, when flipping, the ROI coordinate and detection range coordinate are changed to the one for the flipped status.

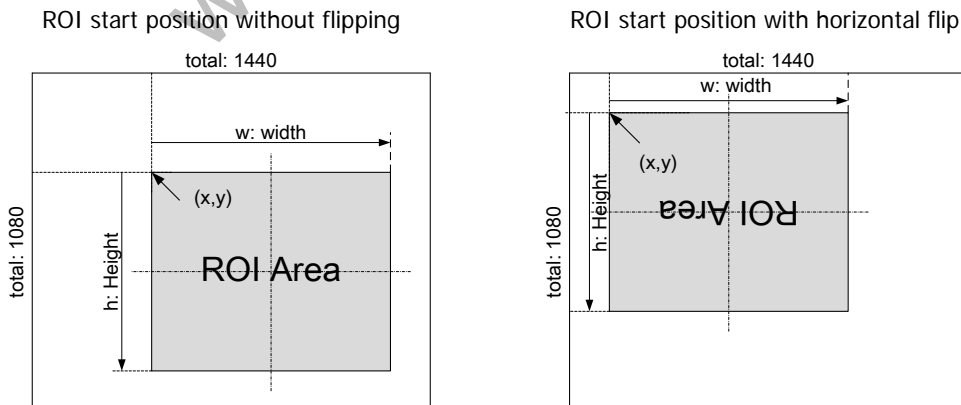

[Note]

- ◆ Shading correction data may not be proper when horizontal flip or vertical flip is performed. If you wish to do shading correction after flipping, please execute shading detection (Address 907).

- ◆ When flipping, Bayer pattern changes.

At normal	RGGB
At horizontal flipping	GRBG
At vertical flipping	GBRG
Horizontal and Vertical flipping	BGGR

4.11. Defective Pixels Correction Function

- This is a function to detect and correct the pixel defects in the data output from the sensor.
- The information on the defective pixels for vertical flipping OFF and for vertical flipping ON are saved separately into different tables.
- Furthermore, in addition to the defective pixels information tables for vertical flipping ON/OFF explained the above, defective pixels data are categorized into two types and controlled.
  - Data at Ex-Factory
    - The detected data of white pixel defects and black pixel defects at Ex-Factory are saved.
    - Basically, these data cannot be erased.
  - Data registered by users
    - Data increased after shipment or the one registered by users.
    - These data can be erased anytime by Entire Deletion of the user defective pixels (Address 914).
    - It cannot be restored by INIT command (SU 0).
- The number of data registerable by users is 128 points. (Note: Up to 32 points per CH).

[CH (Channel)]

Images are processed by four interleave channels in the camera.

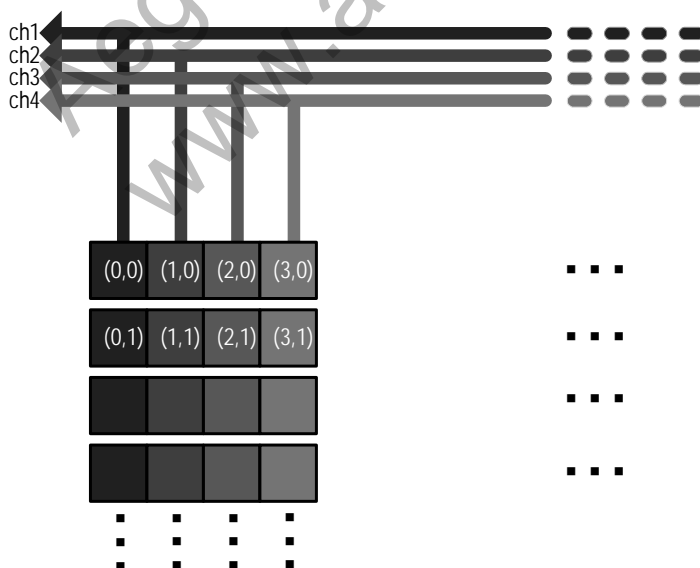

- The registerable number of pixel defects and the correctable number of pixel defects may not be always the same because of the following reasons.
  - (1) With white defects detection, if one of the interleave channels reached the maximum number, correction could not be performed. In such case, the data up to that point are registered, error is output, and operation ends.
  - (2) If no effective pixel exists with up next, down next, right next, or left next to the pixel to be corrected, this pixel can be registered but cannot be corrected.

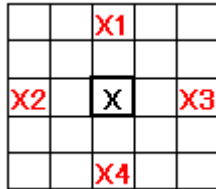

When X1, X2, X3, and X4 are already registered as defected pixels, X can be added to be registered but it cannot be corrected.

- White Defects Detection by users (Address 911)

This is a function to register the pixels automatically if a pixel exceeds the level specified by the user.

Please be noted that no lights should be in the sensor surface to use this function.

There are two kinds of parameters for commands.

The first parameter: Threshold (0~4095)

The data with luminance level more than the specified level here shall be registered.

※ For 8bit output, 16 times more value of the image signal level shall be specified as the threshold value. For 10 bit output, 4 times more value of the image signal level shall be specified as the threshold value.

The Second Parameter: Additional Flag (0, 1)

When 0 is specified, all the white defects data that users registered by that time are cleared

out, and data will be newly registered.

When 1 is specified, only newly detected white defects data will be added to the old data registered by that time.

One of the following messages shall be shown when white defects detect is completed.

OK: Normal

[ERROR] too many user defective pixels: Data number registered by the user exceeds the maximum (128 points).

[ERROR] region data full: Data SUM registered by the user and the one at ex-factory exceeds the limitation for 1 CH. (64 points).

When [ERROR] is shown, please check if the threshold of the first parameter is appropriate, as well as defective pixels indication (Address 915).

[Note]

- ♦ Correction data shall be acquired only when the camera is in operation. When camera is not outputting anything, white defect detection cannot be performed.
- ♦ When detecting white defects, ROI mode shall be OFF. (Size shall be set to 1440x1080 to execute).
- ♦ After detecting, defective pixels correction function will be turned ON.
- ♦ Defective pixels information when vertical flip is OFF and the one when vertical flip is ON are saved into different tables, therefore, only the table used for flipping function at that time shall be updated. In other

words, if user defective pixels detection was performed while vertical flip was ON, only the table for vertical flip ON would be updated, and the table for vertical flip OFF would stay as it was.

- ♦ User defective pixels information can be saved by the SAVE command (SU 5). However, please be noted that if camera power was turned off before saving, user defective pixels information would be restored to the one before saving.
- Entire deletion of defective pixels data registered by users (Address 914)  
This is to delete all defective pixels data detected and registered by users, with Address 911.  
Please execute this when you wish to redo your detection and registration from the beginning, or when you wish to restore all the registration to the factory settings. SU 914 to execute.

[Note]

- ♦ When deleting entire defective pixels, ROI mode shall be turned OFF. (Size shall be set to 1440x1080 to execute)
  - ♦ Defective pixels information when vertical flip is OFF and the one when vertical flip is ON are saved into different tables, therefore, only the user defective pixels data on the table used for flipping function at that time shall be entirely deleted. In other words, if user defective pixels entire deletion was performed while vertical flip was ON, only the table for vertical flip ON would be entirely deleted, and the table for vertical flip OFF would stay as it was.
- Indication of Defective Pixels (Address 915)

Operations when setting data and when acquiring data are different.

(1) When setting (SU 915)

This is a function to indicate the actually corrected pixels by that time, as white. (When defective pixels correction is OFF, there is no corrected pixel so that no white is shown).

On/Off is done by parameters.

Parameter 0: OFF

Parameter 1: ON

- ◇ Bright point indication function cannot be saved.
- ◇ When operational mode is changed, defective pixel indication function will be OFF.

(2) When acquiring (GU 915)

This is a function to indicate the registered defective pixels.

Three kinds of lists can be indicated by parameters.

Parameter 1: Entire list, both ex-factory data, and the added and registered data by users, are shown.

Parameter 2: Only the list added and registered by users is shown.

(Example of indication)

925	443	W
1228	460	W
1271	488	W
1098	520	W
930	629	U

From the left, X coordinate, Y coordinate, and the type of defects.

[Type of defects]

W: White defects registered at Ex-factory

B: Black defects registered at Ex-factory

U: White defects registered by the user

Parameter 3: Indicates the number of the registered defective pixels per CH.

(Data at Ex-factory + Data registered by users.)

Parameter 4: Indicates the number of the registered defective pixels per CH.

(Data registered by users only.)

Parameter 5: Error status of the registered data. Indicates if the data registered by users are appropriate.

[Notes for coordinate indication]

- X coordinate and Y coordinate shown are the one for the current image. When effective angle of field is changed by ROI (SU 41) or others, the coordinates to be indicated shall be changed accordingly.
- The lists shown by parameters 3 and 4 are only the registered data in the currently shown image area. (When indication image size was reduced, some registered data by the user could be out of area. In such case, the coordinate points out of the indication area would not be shown.)
- To show the coordinate points of out of the area, execute parameter 1 or parameter 2. These points would be shown as minus coordinate or as the one of the out of image size.

#### 4.12. User Data Save / Readout Function

This is a function for users to save any data with up to 30 letters (Address 1000).

Set data to the specified address by the command, and issue SAVE command (SU 5) to save the user data.

These data are not restored by INIT command (SU 0). When saving the user data, it can be controlled by a parameter. When reading out the user data, it can be controlled without any parameter.

For the protocol specifications, please refer to the [Section 5. Remote Communication Function](#).

#### 4.12.1 User Data Save

Set a preferred letter string in the user area.  
The minimum of one letter, the maximum of thirty letters can be set.  
Space can be input in the double quotation mark (※).

How to Write

```
【Send】SU[sp]1000 [sp] Data
【Returned Value】[¥r][¥n]
【Returned Value】>[sp]
```

Example to put a space

```
【Send】SU[sp]1000 [sp]"hoge[sp]hoge"
【Returned Value】[¥r][¥n]
【Returned Value】>[sp]
```

Saved Letter String【hoge hoge】

※How to restore the settings

```
【Send】SU[sp]1000 [sp]"" (Set a letter string in the double quotation).
```

#### 4.12.2 Users Data Readout

The set user data can be readout.

```
【Send】GU[sp]1000
【Returned Value】Setting Data[sp][¥r][¥n]
【Returned Value】>[sp]
```

#### 4.13. Reset

With CMOS sensor resetting, the image sensor is rebooted.

### 5. Remote Communication Function

#### 5.1. Serial Communication

With Camera Link serial communication function, the camera can be controlled via external computer and others.

(1) Settings for serial communication is as follows.

Baud rate	115,200bps or 9,600bps
Data	8bit
Stop bit	1bit
Parity	None
XON/XOFF	Not controlled

(2) Control Code

- The total control code conforms to ASCII code.
- A control code consists of command, parameter and CR (0Dh) or LF (0x0a). The changes and acquisition of camera settings can be done by issuing commands from the host equipment.

Command	Parameter 1	Parameter 2~7	Function
GU	Address	None ※	Obtain setting information
SU	Address	Data	Change camera settings
INIT	None	None	Restore to factory settings
SAVE	None	None	Save the camera settings

※Some addresses may need parameter 2~. Please refer to the [Section 5.2](#) for the details.

### (3) How to set a command

- Commands shall be input with capital letters.
- Commands and parameters shall be separated by spaces.
- From the head of the input letter to the line feed code, CR (0x0d) or LF (0x0a), is defined as a command.
- Parameters shall be input as a whole number of decimal numbers. (Decimal fraction or alphabet are invalid). However, user data setting (Address 1000) is an exceptional case.
- Refer to the [Section 5.2. Function Settings](#), for the details on address and data settings.
- Commands other than explained the above, numbers, and letters other than specified in the [Section 5.2. Function Settings](#), cannot be input.
- The sent command is echoed back after it was received.

### (4) Factory Settings

Input "INIT" to restore to the factory settings. (Data cannot be saved at this point).

### (5) Data Save

Input "SAVE" to save the camera settings.

### (6) Setting Examples

#### 【Example of Get Command】

To get the information of the Command No. 40.

[Send] GU[sp]40[¥r] or[¥n]  
 [Returned value] 4[¥r] [¥n] [Acquired data + Linefeed]  
 [Returned value] [¥r] [¥n] [Linefeed]  
 [Returned value] >[sp] [Prompt + Space]

#### 【Example of Set Command】

To set 5 to the Command No. 40.

[Send] SU[sp]40[sp]5[¥r]or[¥n]  
 [Returned value] [¥r] [¥n] [Linefeed]  
 [Returned value] >[sp] [Prompt + Space]

#### 【Example of SAVE Command】

[Send] SAVE[¥r]or[¥n]  
 [Returned value] [¥r] [¥n] [Linefeed]  
 [Returned value] >[sp] [Prompt + Space]

※SAVE Command is equivalent to SU 5.

[¥r]=CR(0x0D)

[¥n]=LF(0x0A)

[sp]=Space(0x20)

## 5.2. Function Settings

Function	Address	Data	Explanation	
Factory settings <b>【WriteOnly】</b>	0	None	Restore to the factory settings. User registered defective pixels, serial baud rate settings (SU 20), and user data settings (SU 1000) shall not be restored.	
Data save <b>【WriteOnly】</b>	5	None	Save the camera settings. Do not turn OFF camera power until the returned value (>) is responded.	
Serial communication Baud rate	20		※ It is not restored by INIT command (SU 0). ※ Baud rate changed is reflected when the camera is booted up next time.	
		9600	9,600baud	
		115200	115,200baud	
Version information <b>【ReadOnly】</b>	21	None	Indicates the revision information on firmware and hardware.	
System information <b>【ReadOnly】</b>	22	0	Camera model name information.	
		1	Camera serial number information.	
Reset <b>【WriteOnly】</b>	29	2	CMOS sensor reset.	
Output bit length and Tap width	40	0	1Tap 8bit output	45.50 fps
		1	2Tap 8bit output	90.75 fps <b>【Factory setting】</b>
		2	2Tap 10bit output	90.75 fps
		3	2Tap 12bit output	90.75 fps
		4	3Tap 8bit output	135.76 fps
Camera operational mode	41	0	Full frame scan (1440 pixels x 1080 Lines fixed)	<b>【Factory setting】</b>
		1	ROI	
Camera Link output clock	49	0	74.250 MHz	<b>【Factory setting】</b>
		1	64.969 MHz	
		2	37.125 MHz	

※ Sensitivity of "Out bit length and Tap width" at 8bit output and the one at 10/12bit output are largely different.

The sensitivity at 8bit output is four times better than the one at 10/12bit output.

※ The initial value of serial baud rate can be selected per ordering. Please refer to the [Section 8.1. Ordering Information](#).

Function	Address	Data	Explanation
Shutter mode	51	0	Continuous reading out shutter mode (Trigger shutter mode OFF). (Shutter speed can be set with the Address 110 and Address 111) <b>【Factory setting】</b>
		1	Fixed Trigger shutter mode (Shutter speed can be set with the Address 110 and 111).
		2	Pulse Width trigger shutter mode (Shutter speed can be set with trigger pulse width).
Trigger polarity	52	0	Positive <b>【Factory setting】</b>
		1	Negative
Trigger input selection	53	0	Camera Link CC1 <b>【Factory setting】</b>
		1	6pins circular connector Trig +
Preset gain	100	0	0dB <b>【Factory setting】</b>
		1	+6dB
		2	+12dB
		3	+18dB
		4	+24dB
		5	+30dB
		6	+36dB
		7	+42dB
	15	Manual gain (Refer to the Address 101)	
Manual gain	101	0 ~ 420	0 ~ +42dB (Can be set per 0.1dB)
Current gain <b>【ReadOnly】</b>	104	None	Gain value in execution is shown with dB.
Preset shutter	110	0 ~ 10	Preset control. (Refer to the <a href="#">Section 5.2.1 The List of Preset Shutter</a> ). <b>【Factory setting=0】</b>
		15	Manual control. (Refer to the Address 111).
Manual shutter	111	5 ~ 1080	At continuous reading out shutter mode, manual shutter can be set per vertical line. *The maximum value varies depending on ROI settings.
		6 ~ 42007	At trigger shutter mode, manual shutter can be set per 1μs.
Current shutter <b>【ReadOnly】</b>	114	None	Indicates the shutter time currently in execution. At continuous reading out shutter mode, it is shown per vertical lines. At fixed trigger shutter mode, it is shown per 1μs. At pulse width trigger shutter mode, it is invalid.

\*Shutter settings are independently different per shutter modes. When changing shutter mode (Address 51), please check exposure time settings (Address 110 and Address 111) as well.

Function	Address	Data	Explanation
White balance select	140	0	OFF
		1	Manual
		2	One Push
One Push start <b>【WriteOnly】</b>	141	None	One Push start trigger
Manual R balance	143	0 ~ 800	Setting value of Manual R (0 ~ 800%) <b>【Factory setting 100】</b>
Manual B balance	145	0 ~ 800	Setting value of Manual B (0 ~ 800%) <b>【Factory setting 100】</b>
White balance One Push detection range	147	4 parameters	The 1 <sup>st</sup> Parameter: Horizontal start pixel (0 ~ 1428 per 4 pixels) The 2 <sup>nd</sup> Parameter: Vertical start line (0 ~ 1074 per 2 lines) The 3 <sup>rd</sup> Parameter: Horizontal effective pixels (12 ~ 1440 per 12 pixels) The 4 <sup>th</sup> Parameter: Vertical effective line numbers (6 ~ 1080 per 2 lines)
Current R balance <b>【ReadOnly】</b>	153	None	Indicates R balance value in execution. (0 ~ 800%)
Current B balance <b>【ReadOnly】</b>	155	None	Indicates B balance value in execution. (0 ~ 800%)
Black level adjustment	250	0 ~ 255	Black level control (Value at 12bit output is shown). <b>【Factory setting =128】</b>
ROI setting parameter set	401	4 parameters	The 1 <sup>st</sup> Parameter: Horizontal start pixel (0 ~ 924[at 8bit]/1176[at 10,12bit] per 4 pixels) The 2 <sup>nd</sup> Parameter: Vertical start line (0 ~ 1076 per 4 lines) The 3 <sup>rd</sup> Parameter: Horizontal effective pixels (516[at 8bit]/264[at 10,12bit] ~ 1440 per 12 pixels) The 4 <sup>th</sup> Parameter: Vertical effective lines (4 ~ 1080 per 4 lines)
Test pattern output	900	0	OFF <b>【Factory setting】</b>
		1	Test pattern (Still)
		2	Test pattern (Movie)
Horizontal flip	902	0	OFF <b>【Factory setting】</b>
		1	ON
Vertical flip	903	0	OFF <b>【Factory setting】</b>
		1	ON
Shading correction	906	0	OFF <b>【Factory setting】</b>
		1	ON
Shading detection <b>【WriteOnly】</b>	907	None	Start calculating the shading correction table. Valid only when camera is in full frame scan operation.
Defective pixel correction	910	0	OFF
		1	ON <b>【Factory Setting】</b>
White spot detection by the user.	911	2 Parameters (None at acquiring)	The 1 <sup>st</sup> Parameter: Threshold (0 ~ 4095) The 2 <sup>nd</sup> Parameter: 0: Re-capturing 1: Additional capturing Users can detect white spots caused later. When capturing, it responds how many spots were detected. It shall not be restored by INIT command (SU 0). Valid only when camera is in full frame scan operation.

Entire deletion of the defective pixels registered by the user. 【WriteOnly】	914	None	Deletes all the defective pixels detected and registered by the user.
Indication of the defective pixels	915	0 at setting	Turn OFF bright spot indication function.
		1 at setting	Indicates the position of the defective pixels as a bright spot while correcting the pixels. ※Bright spot is not shown when correction function is OFF.
		1 at capturing	Indicates all the list of ex-factory data and the registered data by the user.
		2 at capturing	Indicates only the entire list of data registered by the user.
		3 at capturing	Indicates the number of the registered defective pixels in the indication area per strip.
		4 at capturing	List the registered defective pixels by the user in the indication area per strip.
		5 at capturing	Indication of the status.
Cursor indication	918	0	OFF 【Factory setting】
		1	ON
Cursor coordinate	919	2 Parameters	The 1 <sup>st</sup> Parameter: Horizontal cursor position (0 ~ 1439) The 2 <sup>nd</sup> Parameter: Vertical cursor position (0 ~ 1079) (Preset value is the center coordinate) ※The maximum value varies depending on the ROI settings.
User data settings	1000	Parameter 1 (None at acquiring)	Set any letter strings in the user area. The minimum of one letter and the maximum of thirty letters can be set in the letter string. Save settings with SAVE command (SU 5). 【Factory setting = non letter string】 It shall not be restored by the INIT command (SU 0).

## 5.2.1 The List of Preset Shutter

Full frame scan / ROI mode

1440pixels × 1080Lines			
Data	1Tap mode	2Tap mode	3Tap mode
0	1/48@74MHz(OFF) 1/41@64MHz(OFF) 1/24@37MHz(OFF)	1/95@74MHz(OFF) 1/83@64MHz(OFF) 1/47@37MHz(OFF)	1/142@74MHz(OFF) 1/124@64MHz(OFF) 1/71@37MHz(OFF)
1	1/60	1/95@74MHz(OFF) 1/83@64MHz(OFF) 1/60@37MHz	1/142@74MHz(OFF) 1/124@64MHz(OFF) 1/71@37MHz(OFF)
2	1/100	1/100	1/142@74MHz(OFF) 1/124@64MHz(OFF) 1/100@37MHz
3	1/150	1/150	1/150
4	1/200	1/200	1/200
5	1/250	1/250	1/250
6	1/500	1/500	1/500
7	1/1000	1/1000	1/1000
8	1/2000	1/2000	1/2000
9	1/5000	1/5000	1/5000
10	1/10000	1/10000	1/10000
15	Manual		

※ When the shutter time becomes bigger than its frame rate at continuous reading out shutter mode, it shall be clipped to the exposure time for that frame rate automatically.

## 5.2.2 Calculating Exposure Time

- Exposure time at continuous reading out shutter mode can be calculated by the 1H width of each output in the table below and the setting value of the Address 114.

Formula: Exposure Time = 1H width × Setting value of the Address 114 + 14μs

		1H Width for each mode		
		74.25MHz	64.969MHz	37.125MHz
Full frame, ROI	1tap 8bit	19.45μs	22.25μs	38.9μs
	2tap 8/10/12bit	9.751μs	11.15μs	19.5μs
	3tap 8bit	6.519μs	7.46μs	13.04μs

- Exposure time at fixed trigger shutter mode can be calculated as below.

Formula: Exposure Time = Setting value of the Address 114 + 14μs

The minimum setting value is 6μs.

- Exposure time at pulse width trigger shutter mode can be calculated as below.

Formula: Exposure Time = Pulse width + 14μs

The minimum trigger pulse width is approx. 6μs.

## 5.2.3 Functions Unable to Set at the Same Time

Function / Operational mode	Full frame (1440x1080)	ROI
Defective pixels correction	○	○
Shading correction	○	○
Test pattern or Cursor indication	○	○
Defective pixels detection by users	○	×
Shading detection	○	×
White Balance One Push	○	○
White Balance	○	○
Vertical flip / Horizontal flip	○	○

Aegis Electronic Group  
www.aegiselect.com

6. Dimensions

6.1. Camera Dimensions

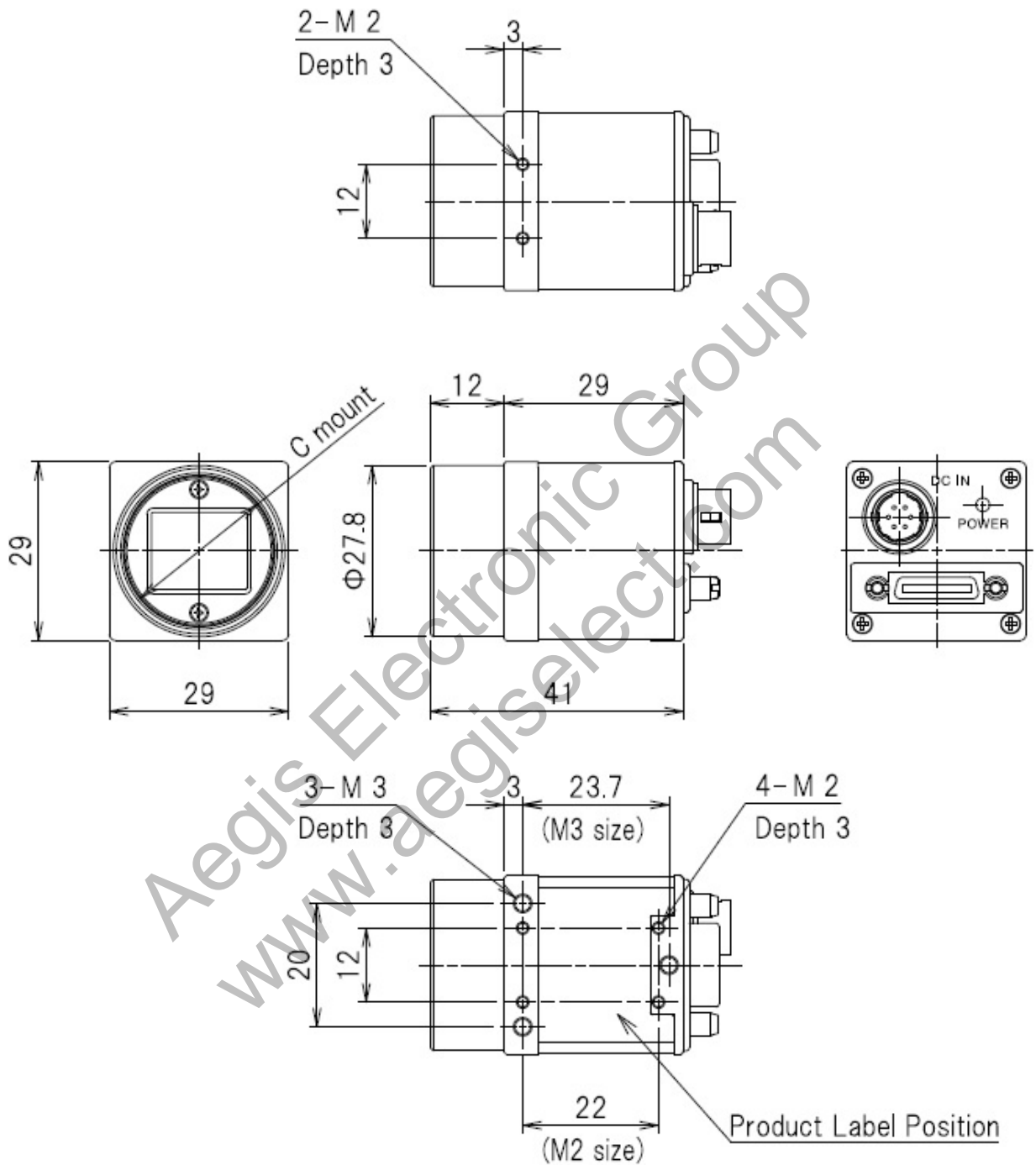

- 2) C mount screws comply with ANSI/ASME B1.1,1-32UN(2B).  
 1) Screw length from the lens mount surface shall be less than 6mm. And protruding portion of the C mount lens shall be less than 10mm.

935-0054-00  
 (Unit:mm)

6.2. Optical Axis Accuracy

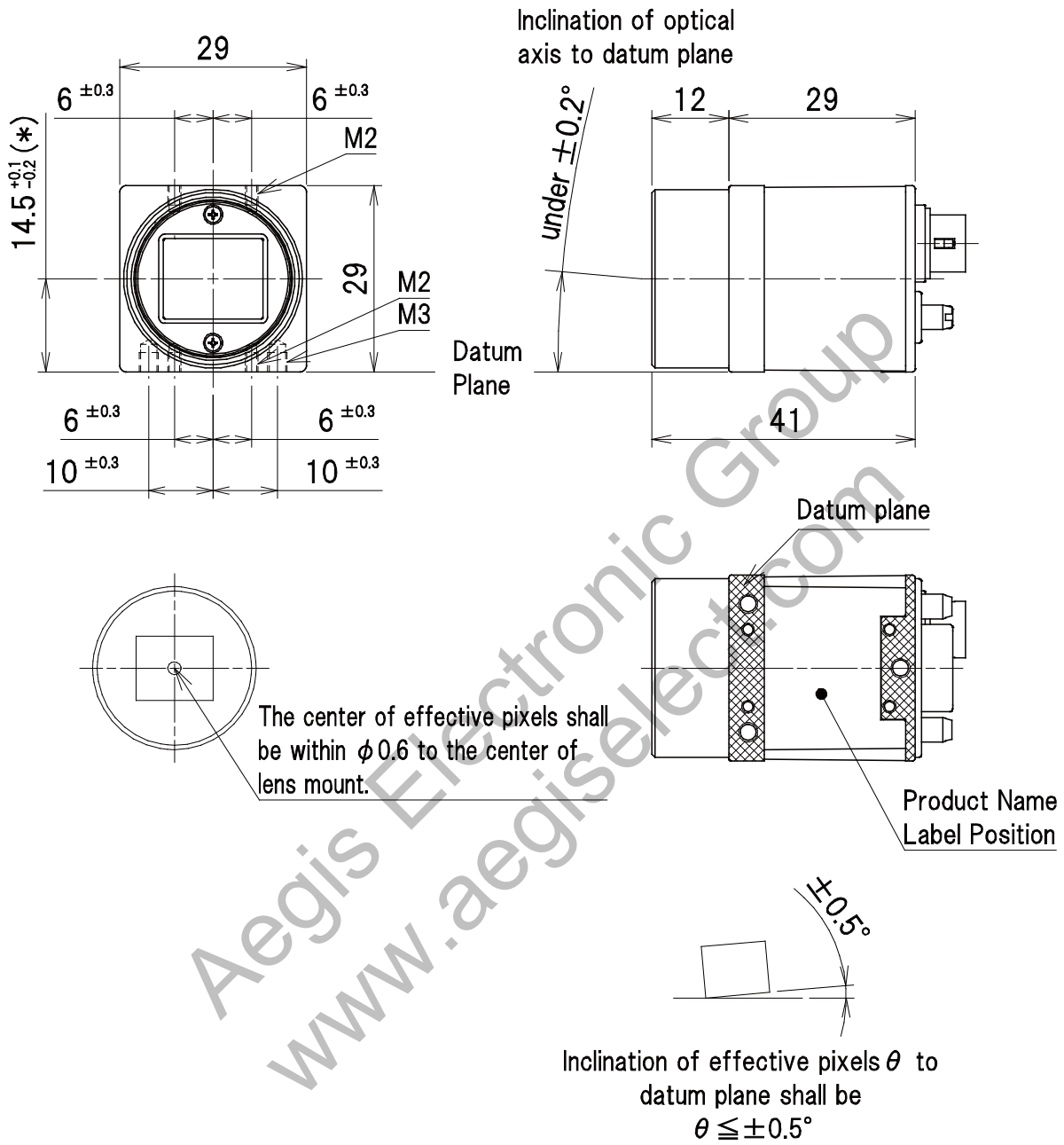

(\*)Dimension from datum plane to the center of lens mount.

937-0009-01  
(Unit:mm)

## 7. Case for Indemnity

### 7.1. Product Warranty

The term of warranty of this product is within 3 years from the date of shipping out from our factory.

If you use the product properly and discover a defect during the warranty period, and if that was caused by designing or manufacturing, CIS Corporation, at its option, repairs or replaces it at no charge to you.

Products out of warranty period will be subject to charge. CIS repairs the products as long as it is repairable.

CIS shall be exempted from taking responsibility and held harmless for damages or losses incurred by the following cases.

- In case, damages or losses are caused by earthquake, lightning strike, fire, flood, or other acts of God.
- In case, damages or losses are caused by deliberate or accidental misuse by the user, or failure to observe the information contained in the instructions in this Product Specification and Operational Manual.

In case, damages or losses are caused by repair or modification conducted by the customer or any unauthorized party.

### 7.2. CMOS Pixel Defects

CIS compensates the noticeable CMOS pixel defects found at the shipping inspection prior to our shipment. On very rare occasions, however, CMOS pixel defects might be noted with time of usage of the products. Cause of the CMOS pixel defect is the characteristic phenomenon of CMOS sensor itself and CIS is exempted from taking any responsibilities for them. Should you have any questions on CMOS pixel defects compensation please contact us.

## 8. Supplementary Note

### 8.1. Ordering Information

Baud rate is selectable for VCC-SXCL5R out of the two baud rates below. Please select and specify which baud rate you choose when ordering. (Please be noted that baud rate cannot be changed by user settings, but only by factory settings at its delivery).

Model name	Baud rate (bps)
VCC-SXCL5R	9,600
VCC-SXCL5R-1	115,200

### 8.2. Product Support

Should you have any problems in function of the product you purchased, and if you need our further analysis and/or repair, please contact the dealer you purchased it from.