

CIS

CoaXPress I/F
25M CMOS B/W Camera

VCC-25CXP1MBN

Product Specifications
& Operational Manual

CIS Corporation

Table of Contents

1.	Handling Precautions	3
1.1.	Camera Handling Precautions	3
1.2.	Restrictions on Applications	3
1.3.	Disclaimers (Exception Clause)	3
2.	Product Outline	4
2.1.	Features	4
2.2.	Bundled Items	4
3.	Specifications	5
3.1.	General Specifications	5
3.2.	Input and Output	6
3.2.1	Trigger Input (12pins circular connector, No.11 pin)	6
3.2.2	Exposure Output (12pins circular connector, No.9 pin)	6
3.2.3	FVALL_OUT/LVAL_OUT/ UplinkTrigger_OUT (12pins circular connector, No.6, 7, and 10 pin)	7
3.3.	External Connector Pin Assignment	7
3.3.1	12pins Circular Connector	7
3.3.2	75Ω DIN Connector (Quad-type)	7
3.3.3	LED Indicator	8
3.4.	Spectral Response	8
4.	Camera Operational Function	8
4.1.	Control System	8
4.2.	Device Information	9
4.3.	LED Operational Mode	9
4.4.	Temperature Indication	9
4.5.	Partial Scan (ROI)	10
4.6.	Binning	13
4.7.	Flip	13
4.8.	Pixel Format	13
4.9.	Bit Range	13
4.10.	Cursor Indication	14
4.11.	Test Pattern Indication	14
4.12.	Trigger Mode	15
4.12.1	Internal Sync. Mode (Free Run Mode)	15
4.12.2	External Sync. Mode	15
4.12.2.1	Restrictions on Trigger Pulse Input Timing	16
4.12.2.2	Trigger Pulse Input Timing and Exposure Start Delay Time	16
4.12.2.3	Fixed Trigger Shutter Mode	16
4.12.2.4	Pulse Width Trigger Shutter Mode	17
4.13.	Exposure Time	18
4.14.	Gain	20
4.15.	Black Level Adjustment	20
4.16.	Shading Correction	21
4.17.	Defective Pixels Correction	22
4.18.	Link Speed and Link Count	25
4.19.	How to Save and Initialize the Settings	25
4.20.	Sequence Control Function	25
4.20.1	Basic Operation for Sequence Control Function	26
4.20.2	Trigger Mode and Burst Mode Operational Outline	26
4.20.3	Trigger Mode	27
4.20.4	Burst Mode	28
4.20.5	Index Mode	29

- 4.20.6 Setting for Sequence Control..... 30
- 4.20.7 Sequence Status Information 33
- 5. Factory Settings 34
- 6. Dimensions 35
 - 6.1. Camera Dimensions..... 35
 - 6.2. CMOS Optical Axis Accuracy 36
- 7. Case for Indemnity (Limited Warranty) 37
 - 7.1. Product Warranty 37
 - 7.2. CMOS Pixel Defect..... 37
 - 7.3. Product Support..... 37

Aegis Electronic Group
www.aegiselect.com

1. Handling Precautions

1.1. Camera Handling Precautions

- Do not use or store the camera in the extremely dusty or humid places.
- Do not apply excessive force or static electricity that could damage the camera. Handle the camera with care.
- Do not shoot direct images that are extremely bright (e.g., strong light source, sun, etc.). When strong light such as spot light was shot, blooming or smear may occur. Put the lens cap on when camera is not in use.
- Follow the instructions in [Chapter 3.3, "External Connector Pin Assignment"](#) for connecting the camera module. Improper connection may cause damages not only to the camera module but also to the connected devices.
- Confirm the mutual ground potential carefully before connecting the camera to monitors or computers. Any AC leaks or coupling noises from the connected devices may cause damages or destroy the camera.
- Do not apply excessive voltage. (Use only the specified voltage.) Unstable or improper power supply voltage may cause damages or malfunction of the camera assembly.
- The voltage ripple of camera power DC+12~24V±10% shall be within ±50mV. Improper power supply voltage may cause noises on the video signals.
- The rising time of camera power supply voltage shall be less than +10V, Max. 60ms. Please avoid noises like chattering when rising.
- Our warranty does not apply to damages or defects caused by irregular and/or abnormal use of the product.

1.2. Restrictions on Applications

- The camera must not be used for any nuclear equipment or aerospace equipment with which mechanical failure or malfunction could result in serious bodily injury or loss of human life.
- The camera must not be used under conditions or environments other than specified in this manual.

1.3. Disclaimers (Exception Clause)

- In case damages or losses are caused by earthquake, lightning strike, fire, flood, or other acts of God.
- In case damages or losses are caused by deliberate or accidental misuse by the user, or failure to observe the information contained in the instructions in this Product Specification and Operational Manual.
- In case damages or losses are caused by repair or modification conducted by the customer or any unauthorized party.

2. Product Outline

VCC-25CXP1MBN is a CoaXPress interfaced B/W camera utilizing APS-H type, 25M pixels CMOS image sensor.

2.1. Features

- 65mm x 65mm x 65mm cubic in size
- Global shutter type CMOS (Monochrome)
- CoaXPress CXP-1, CXP-2, CXP-3, CXP-5, and CXP-6
- 4 Lanes
- PoCXP
- The maximum cable length: Approx. 100m at CXP-1, and approx. 40m at CXP-6.
- ROI
- Sub-sampling
- Exposure time, Gain settings
- External trigger mode (Fixed trigger shutter mode / Pulse width trigger shutter mode)
- GenICam complied
- M48 lens mount

2.2. Bundled Items

- Standard Bundled Items
 - ♦ Camera module, VCC-25CXP1MBN
- Optional Items
 - ♦ M48 to F lens mount conversion adaptor
- Packaging
 - ♦ Individual carton

3. Specifications

3.1. General Specifications

Electrical Specifications			
Pick Up Device	Device type	APS-H type, Global shutter type CMOS sensor	
	Effective pixel number	5120(H) × 5120(V)	
	Unit cell size	4.5μm(H) × 4.5μm(V)	
Video Output Mode		Ver.1.1.1 complied CXP6 / CXP5 / CXP3 / CXP2 / CXP1 ×4 each CXP6_X1,CXP6_X2	
Video Output Frequency	Pixel clock frequency	72MHz	
Video Output Format		Mono 8 / Mono 10	
Frame Rate	CXP1 8bit/10bit	17.17fps/13.73fps	
	CXP2 8bit/10bit	30.52fps/24.41fps	
	CXP3 8bit/10bit	40.13fps/33.80fps	
	CXP5 8bit/10bit	68.40fps/54.72fps	
	CXP6 8bit/10bit	81.83fps/65.10fps	
Video Output Pixel Size (Max. Pixel Size)		5120 (H) × 5120(V)	
Video Signals (Gain 0dB)	White clip level	FFh	At Mono 8
	Set up level	02h±02h	At Mono 8, and at factory setting
	Dark shading	0~2(H), 0~5(V)	At Mono 8, and at factory setting
Sensitivity		F8 400lx (Shutter speed 1/30s, Gain 0dB)	
Minimum Illumination		F1.4 5.2lx (Gain +18dB, Shutter OFF, level=50%)	
Gain Variable Range		x1~x8 (0dB~18dB) [Warranty scope]	
Shutter Speed		Preset: 1/30000, 1/10000, 1/5000, 1/2000, 1/1000, 1/500, 1/200, 1/100, 1/60, 1/50, 1/30 [s] Manual: 30[μs]~72590[μs]	
Gamma Correction		None (γ=1)	
Trigger Mode		Free run mode (Camera internal trigger) Trigger mode (Host, external trigger) •Fixed trigger shutter •Pulse width trigger shutter	
Partial Scan		10 Preset patterns (4096x4096, 4096x3072, 3840x2896, 3840x2160, 2560x2048, 2048x2048, 2048x1440, 1920x1200, 1920x1080, 1280x1024)	
Sequence Function		For each 16 parameter set, Start (X,Y) coordinate, Horizontal size, Vertical size, Exposure, and Gain settings Control mode: Trigger mode, Burst mode, and Index mode	
Power Requirements		12pins circular connector or PoCXP 12pin: 12~24V	
Power Consumption		7.8W(CXP-1), 10.6 W (CXP-6), [At free run]	
Mechanical Specifications			
Dimensions		H:65mm W:65mm D:65mm (Without protruding portion)	
Weight		Approx. 290g	
Lens Mount		M48 mount	

Environmental Specifications			
Safety/Quality Standard			
UL: Conform to UL for all the materials. CE: EMC: 2014/30/EU Conform to EN61000-6-4:2007+A1:2011 for Emission Conform to EN61000-6-2:2005 for Immunity RoHS: 2011/65/EU Conform to EN50581 (RoHS2)			
Durability	Vibration	Acceleration	: 98m/s ² (10G)
		Frequency	: 20 ~ 200Hz
		Direction	: X, Y, and Z 3directions
		Testing time	: 120min for each direction
	Shock	No malfunction shall occur with the maximum 980m/s ² (100)G for $\pm X$, $\pm Y$, and $\pm Z$ 6 directions without packaging.	
Operation Guaranteed Environment		0 ~ +45°C Humidity: 20~80%RH with no condensation.	
Storage Environment		-25 ~ +60°C Humidity: 20~80%RH with no condensation.	

3.2. Input and Output

3.2.1 Trigger Input (12pins circular connector, No.11 pin)

- 5.0V, 3.3V CMOS level input (TTL level)
- Input voltage Low: 0.5Vdc (Max.), High: 2.1Vdc (Min.)
- To use this terminal, please set Trigger Source of AcquisitionControl to OutsideTTL.

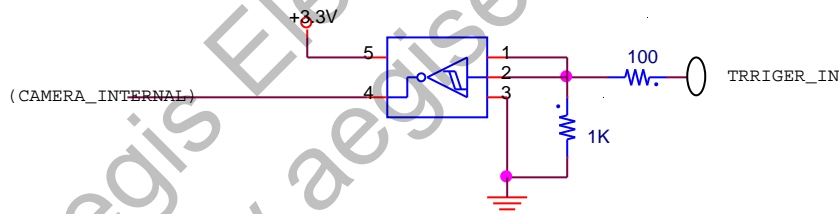

3.2.2 Exposure Output (12pins circular connector, No.9 pin)

- 5.0V, CMOS logic level output
- Output voltage Low: 0.55Vdc (Max.), High: 3.8Vdc (Min.)

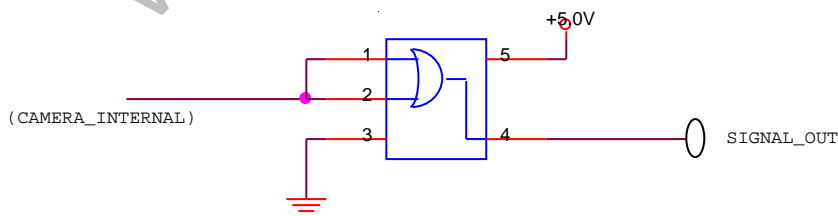

3.2.3 FVALL_OUT/LVAL_OUT/ UplinkTrigger_OUT (12pins circular connector, No.6, 7, and 10 pin)

- 5.0V, CMOS logic level output
- Output voltage Low: 0.55Vdc (Max.), High: 3.8Vdc (Min.)

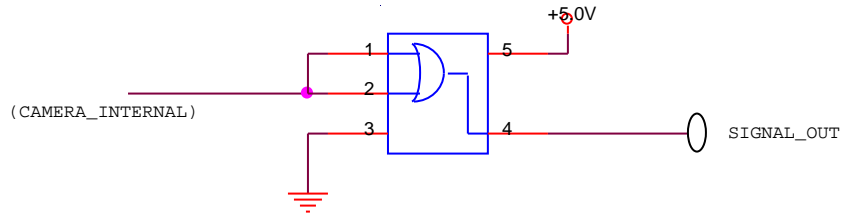

3.3. External Connector Pin Assignment

3.3.1 12pins Circular Connector

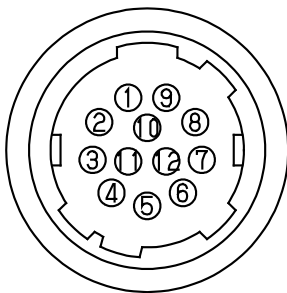

HR10-10R-12PA(73)
(HIROSE or equivalent)

Pin No.	Signals	Note
1	GND	GND
2	Power	External power input
3	NC	
4	NC	
5	GND	GND
6	LVAL_OUT	Line read out signals output
7	FVAL_OUT	Frame read out signals output
8	GND	GND
9	EXPOSURE_OUT	Sensor exposure signals output
10	LinkTrigger_OUT	External trigger signals output from the Host Device (LinkTrigger0)
11	TRIGGER_IN	External trigger input (Line0)
12	GND	GND

※NC=Non-Connection. Do not connect anything to the terminal.

※LinkTrigger_OUT is the signal to monitor the external trigger signals from the Host Device.

3.3.2 75Ω DIN Connector (Quad-type)

- CoaXPress Video output signals (4 lines need to be connected).
- No.1 pin is the connector for PoCXP.

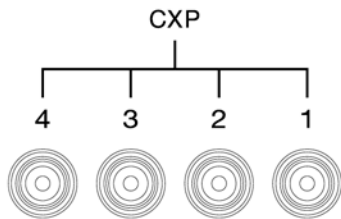

(Cambridge Connectors)

3.3.3 LED Indicator

- When it is ON, Lighting patterns of LED shows the camera status by the way of its lighting.

OFF	No Power supplied
Green/Orange Fast Blinking [12.5Hz]	4 cable lines are not connected.
Green Lighting	Confirmed connection of the device and the host.
Green Fast Blinking [12.5Hz]	Transmitting video data.
Orange Slow Blinking [1Hz]	Waiting for the trigger input
Red Slow Blinking [0.5Hz]	System error occurred or inappropriate trigger input.

3.4. Spectral Response

- ※ The lens characteristics, the IR cut filter characteristics, and the illuminant characteristics are excluded.

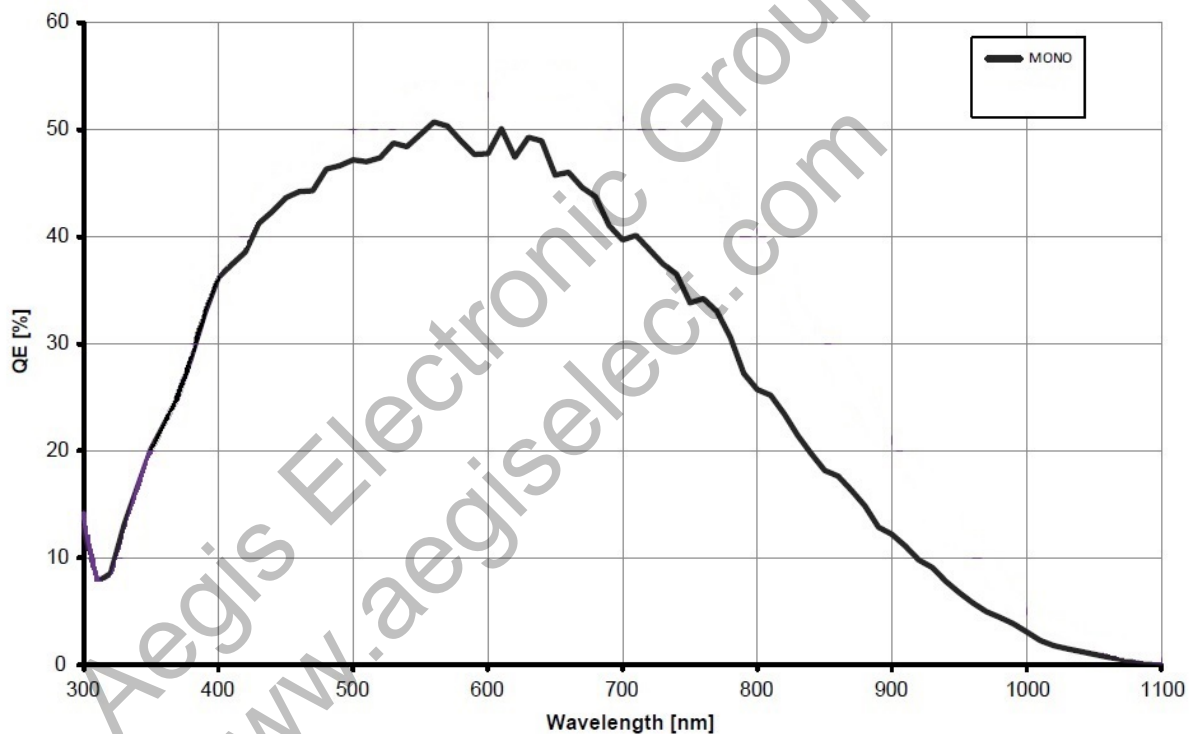

4. Camera Operational Function

4.1. Control System

- Complies with CoaXPress standard.

[Note] The indication of the parameter name for the commands may vary depend on the software you use.

4.2. Device Information

- This is to indicate the camera status.

DeviceControl	
DeviceModelName	(ReadOnly)
DeviceVersion	(ReadOnly)
DeviceFirmwareVersion	(ReadOnly)
DeviceSerialNumber	(ReadOnly)

- DeviceModelName : Model name of the camera
- DeviceVersion : Circuit version
- DeviceFirmwareVersion : Firmware version
- DeviceSerialNumber : Serial number of the camera

- A letter string consisting of the maximum 16 characters, including the terminal NUL letter (\0), can be set to the camera. To save it into the volatile memory of the camera, execute "UserSetSave". Execute "UserSetDefault" to restore it to the factory setting.

DeviceControl	
DeviceUserID	[User definition]

4.3. LED Operational Mode

- This is to change LED operation of the camera rear. For the lighting patterns, please refer to the LED Indicator.

DeviceControl	
DeviceIndicatorMode	Active ErrorStatus Inactive

- Active : Indicate the communication status of CoaXPress
- ErrorStatus : Off at normal operation.
Lights only when video transmitting error occurs or when an inappropriate trigger is input.
- Inactive : ALL LED OFF

4.4. Temperature Indication

- This is to indicate the temperature register value of the camera sensor.

DeviceControl	
DeviceTemperature	(ReadOnly)

[Note]

- The register value is not calibrated.
Temperature register value (Referenced value)

Sensor Temperature [°C]	30	40	50
DeviceTemperature value	94	108	122

4.5. Partial Scan (ROI)

- This is to increase its frame rate by cutting out and reducing the read out area.
- This function cannot be used with binning mode.

ImageFormatControl	
Width	
Height	
OffsetX	X coordinate
OffsetY	Y coordinate
ROIQuickChange*	(Execute)

- Preset ROI
 - "Width", "Height", "OffsetX", and "OffsetY" shall be updated when "ROIQuickChange(Xsize)x(Ysize)" is executed.
 - 10 patterns of ROI are prepared as preset ROI.
 - When "ROIQuickChange(Xsize)x(Ysize)" is executed, ROI is to be cut out from the center.
 - Execute "ROIQuickChangeOff" to get back to the Full size of 5120x5120.
 - The frame rates for each "ROIQuickChange(Xsize)x(Ysize)" shall be as the chart below, "Preset ROI frame rate", depending on their image size, pixel format, and link rate.
- Custom ROI
 - With Width, ROI size of X direction can be specified per 64 pixels.
 - With Height, ROI size of Y direction can be specified per 2 pixels.
 - With OffsetX, the offset from the left side in X direction of ROI can be specified per 64 pixels.
 - With OffsetY, the offset from the top side in Y direction of ROI can be specified per 2 pixels.
 - OffsetX and OffsetY shall be set as follows.

$$\text{OffsetX} + \text{Width} \leq 5120, \text{OffsetY} + \text{Height} \leq 5120$$

- The frame rates for the customized ROI shall be limited by the frame rates defined in the "Preset ROI frame rate" as shown in the chart in the next page "Custom ROI frame rate" depending on its Width and Height.

[Note]

- Frame rate shall be limited only at internal sync. mode. At external sync. mode, the frame rate shall operate with external trigger cycle.
- In case of external sync. mode and the Height is 1024 or more, frame rate shall be changed to line shape with Height. In case of Height is less than 1024, frame rate shall not be changed to line shape with Height. Please refer to [Section 4.12.2.2](#) and note that there are restrictions on trigger pulse input timing.

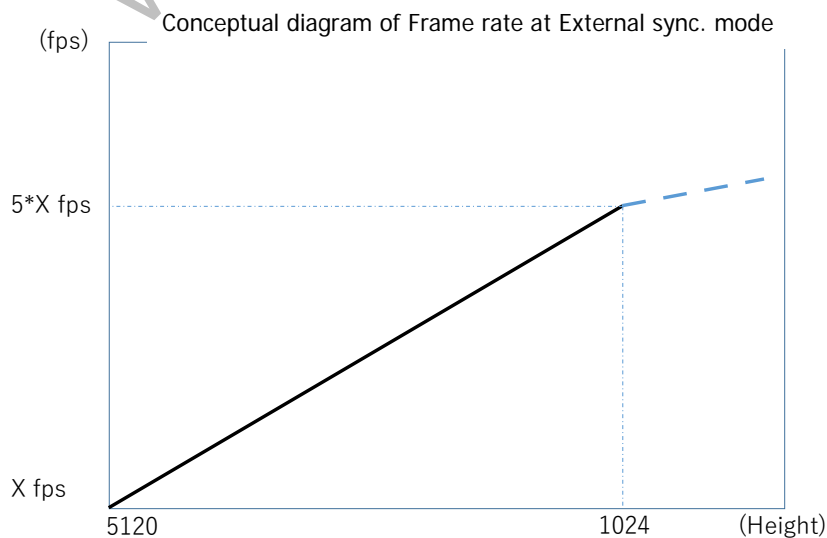

Preset ROI frame rate [fps]

ROI Setting mode (WidthxHeight,OffsetX,OffsetY)	Known as	PixelFormat	Link rate				
			CXP1_X4	CXP2_X4	CXP3_X4	CXP5_X4	CXP6_X4
ROIQuickChangeOff (5120x5120,0,0)	25M	mono8	17.17	30.52	40.13	68.40	81.38
		mono10	13.73	24.41	33.80	54.72	65.10
ROIQuickChange4096x4096 (4096x4096,512,512)	16M	mono8	23.88	43.95	61.04	87.90	124.67
		mono10	18.62	39.24	49.94	79.18	99.74
ROIQuickChange4096x3072 (4096x3072,512,1024)	12M	mono8	30.52	57.82	78.47	115.65	162.76
		mono10	24.97	52.32	68.67	102.21	130.21
ROIQuickChange3840x2896 (3840x2896,640,1112)	10M	mono8	34.33	64.75	87.03	125.57	175.81
		mono10	26.80	58.21	75.77	114.16	140.63
ROIQuickChange3840x2160 (3840x2160,640,1480)	4K QFHD	mono8	45.78	82.92	118.78	154.20	231.32
		mono10	34.88	75.77	102.21	137.34	185.05
ROIQuickChange2560x2048 (2560x2048,1280,1536)	5M	mono8	54.93	114.16	122.07	175.69	244.14
		mono10	40.69	94.51	122.07	175.69	195.31
ROIQuickChange2048x2048 (2048x2048,1536,1536)	4M	mono8	57.82	122.07	122.93	189.04	244.14
		mono10	42.26	109.87	122.93	189.04	195.31
ROIQuickChange1920x1440 (1920x1440,1600,1840)		mono8	78.47	169.03	169.03	244.14	351.12
		mono10	61.04	156.96	169.03	244.14	281.29
ROIQuickChange1920x1200 (1920x1200,1600,1960)	WUXGA	mono8	91.56	199.76	199.76	288.18	399.52
		mono10	73.24	187.02	199.76	288.18	319.69
ROIQuickChange1920x1080 (1920x1080,1600,2020)	FullHD	mono8	109.87	222.52	222.52	313.97	462.75
		mono10	78.47	204.42	222.52	313.97	370.10
ROIQuickChange1280x1024 (1280x1024,1920,2048)	SXGA	mono8	122.07	244.14	244.14	374.11	487.57
		mono10	84.52	219.73	244.14	374.11	390.63

ROI Setting mode (WidthxHeight,OffsetX,OffsetY)	Known as	PixelFormat	Link rate	
			CXP6_X1	CXP6_X2
ROIQuickChangeOff (5120x5120,0,0)	25M	mono8	17.17	40.13
		mono10	13.73	33.80
ROIQuickChange4096x4096 (4096x4096,512,512)	16M	mono8	23.88	61.04
		mono10	18.62	49.94
ROIQuickChange4096x3072 (4096x3072,512,1024)	12M	mono8	30.52	78.47
		mono10	24.97	68.67
ROIQuickChange3840x2896 (3840x2896,640,1112)	10M	mono8	34.33	87.03
		mono10	26.80	75.77
ROIQuickChange3840x2160 (3840x2160,640,1480)	4K QFHD	mono8	45.78	118.78
		mono10	34.88	102.21
ROIQuickChange2560x2048 (2560x2048,1280,1536)	5M	mono8	54.93	122.07
		mono10	40.69	122.07
ROIQuickChange2048x2048 (2048x2048,1536,1536)	4M	mono8	57.82	122.93
		mono10	42.26	122.93
ROIQuickChange1920x1440 (1920x1440,1600,1840)		mono8	78.47	169.03
		mono10	61.04	169.03
ROIQuickChange1920x1200 (1920x1200,1600,1960)	WUXGA	mono8	91.56	199.76
		mono10	73.24	199.76
ROIQuickChange1920x1080 (1920x1080,1600,2020)	FullHD	mono8	109.87	222.52
		mono10	78.47	222.52
ROIQuickChange1280x1024 (1280x1024,1920,2048)	SXGA	mono8	122.07	244.14
		mono10	84.52	244.14

Custom ROI frame rate [fps] (In case of CXP6_X4 at mono8 and AcquisitionMode)

Width Height	5120 \geq	4096 \geq	3840 \geq	2560 \geq	2048 \geq	1920 \geq	1280 \geq
5120 \geq	81.38	81.38	81.38	81.38	81.38	81.38	81.38
4096 \geq	81.38	124.67	124.67	124.67	124.67	124.67	124.67
3072 \geq	81.38	162.76	162.76	162.76	162.76	162.76	162.76
2896 \geq	81.38	162.76	175.81	175.81	175.81	175.81	175.81
2160 \geq	81.38	162.76	231.32	231.32	231.32	231.32	231.32
2048 \geq	81.38	162.76	231.32	244.14	244.14	244.14	244.14
1440 \geq	81.38	162.76	231.32	244.14	244.14	351.12	351.12
1200 \geq	81.38	162.76	231.32	244.14	244.14	399.52	399.52
1080 \geq	81.38	162.76	231.32	244.14	244.14	462.75	462.75
1024 \geq	81.38	162.76	231.32	244.14	244.14	462.75	487.57

Note 1) in the above chart is the frame rate defined by ROIQuickChange(Width)x(Height).

Note 2) is defined by "Preset ROI frame rate" in case of when link rate is other than link rate=CXP6_X4, and in case of when PixelFormat=mono10. The value shall be limited to the smaller value in each Width and Height.

4.6. Binning

- 4 pixels of horizontal and vertical shall be mixed and output as 1 pixel.

ImageFormatControl	
BinningMode	Off Sum Average

- ◆ BinningMode
 - ◆ Off : Binning OFF
 - ◆ Sum : To sum up the values of 4 pixels.
 - ◆ Average : To average the values of 4 pixels.

- The number of pixels shall be 2560×2560.
- Binning mode cannot be used with partial scan (ROI).
- The frame rate at binning mode is the same as when ROI is OFF (5120x5120).

[Note]

- ◆ When ValidDataSelector is at Lower8bit, Sum cannot be selected at Binning mode.

4.7. Flip

ImageFormatControl	
ReverseX	True/False
ReverseY	True/False

- ◆ ReverseX : This is to flip the image of X direction
- ◆ ReverseY : This is to flip the image of Y direction

4.8. Pixel Format

ImageFormatControl	
PixelFormat	Mono8 Mono10

- ◆ Mono8 : Monochrome 8bit
- ◆ Mono10 : Monochrome 10bit

4.9. Bit Range

- This is to set the figure to cut out 8bit data from 10bit data of the sensor.

ImageFormatControl	
ValidDataSelector	Upper8bit Lower8bit

- ◆ ValidDataSelector : Select the effective figures at Mono8.
 - ◆ Uppre8bit : The upper 8bit are to be used.
 - ◆ Lower8bit : The lower 8bit are to be used.

- This is to be ignored at Mono10.

[Note]

- ◆ When ValidDataSelector is at Lower8bit, Sum cannot be selected at Binning mode.

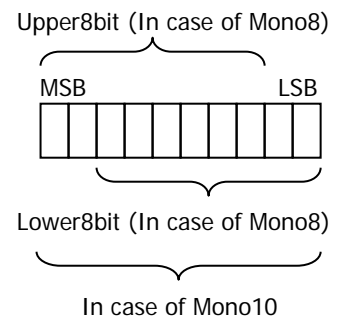

4.10. Cursor Indication

- Cursor can be shown on the screen.

ImageFormatControl	
ShowCursor	On/Off
CursorX	X coordinate
CursorY	Y coordinate
CursorColor	White/Black

- ShowCursor : This is to specify if the cursor shall be indicated or not. (On/Off)
- CursorX : This is to specify the X coordinate of the vertical cursor.
- CursorY : This is to specify the Y coordinate of the vertical cursor.
- CursorColor : This is to specify the color of the cursor. (Black or White)

[Note]

- ♦ When Reverse or ROI are shown, cursor coordinates shall be as follows.
 - ReverseX=False, ReverseY=False: The top left of ROI screen is the origin of (0,0)
 - ReverseX=True, ReverseY=False: The top right of ROI screen is the origin of (0,0)
 - ReverseX=False, ReverseY=True: The bottom left of ROI screen is the origin of (0,0)
 - ReverseX=True, ReverseY=True: The bottom right of ROI screen is the origin of (0,0)
- ♦ Cursor may not be shown when the screen size is scaled down.
- ♦ Cursor indication cannot be set when test pattern indication is ON.

4.11. Test Pattern Indication

- Test pattern can be output from the camera. It is useful to check if your system is operating properly.

ImageFormatControl	
TestPattern	ON/OFF

[Note]

- ♦ This function cannot be set when cursor indication is ON.

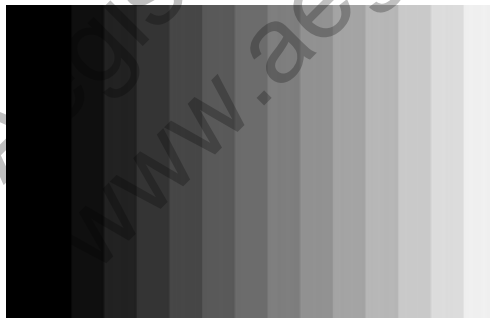

4.12. Trigger Mode

Acquisition Control	
TriggerSelectorAndActivation	AcquisitionMode FrameStartRisingEdge FrameStartFallingEdge FrameStartLevelHigh FrameStartLevelLow FrameBurstStart
TriggerSource	LinkTrigger0 Line0
TriggerSoftware	(Execute)
AcquisitionFrameRate	(ReadOnly)

- ◆ TriggerSelectorAndActivation : Trigger selector
This is to select how to start capturing video and polarity from the below.
 - ◆ AcquisitionMode : Free run mode (Internal sync. mode)
 - ◆ FrameStartRisingEdge : Fixed trigger shutter mode: Rising edge (External sync. mode)
 - ◆ FrameStartFallingEdge : Fixed trigger shutter mode: Falling edge (External sync. mode)
 - ◆ FrameStartLevelHigh : Pulse width trigger shutter mode: High active (External sync. mode)
 - ◆ FrameStartLevelLow : Pulse width trigger shutter mode: Low active (External sync. mode)
 - ◆ FrameBurstStart : Burst mode of Sequence function (Internal sync. mode)
- ◆ TriggerSource : Trigger source
This is to select where to input the external trigger.
 - ◆ LinkTrigger0 : External trigger input from the CoaXPress Host Device.
Please refer to the specification manual for the Host Device such as grabber board, to know how to generate the triggers.
 - ◆ Line0 : External trigger input from the 12pins circular connector.
- ◆ TriggerSoftware : Software trigger
This is to generate a trigger in the camera internally to capture 1 frame image.
This command is valid when TriggerSelectorAndActivation is FrameStartRisingEdge or FrameBurstStart.
- ◆ AcquisitionFrameRate : Frame rate of internal sync. mode
This is to indicate the frame rate for internal sync. mode.

4.12.1 Internal Sync. Mode (Free Run Mode)

- This is the mode to use triggers continuously generated in the camera instead of external trigger input.
- Set TriggerSelectorAndActivation to AcquisitionMode.
- Frame rates [fps] when ROI is invalid are as follows.

PixelFormat	CXP1_X4	CXP2_X4	CXP3_X4	CXP5_X4	CXP6_X4	CXP6_X2	CXP6_X1
mono8	17.17	30.52	40.13	68.40	81.38	40.13	17.17
mono10	13.73	24.41	33.80	54.72	65.10	33.80	13.73

4.12.2 External Sync. Mode

- This is the mode to capture images with preferred timing by inputting external trigger signals.
- Set "TriggerSelectorAndActivation" to other than "AcquisitionMode".

4.12.2.1 Restrictions on Trigger Pulse Input Timing

- The trigger for the next frame can be input while reading out the prior frame, however, the timing to end exposure while reading out the prior frame is restricted. In other words, the timing to start the next reading while reading out the prior frame is restricted.

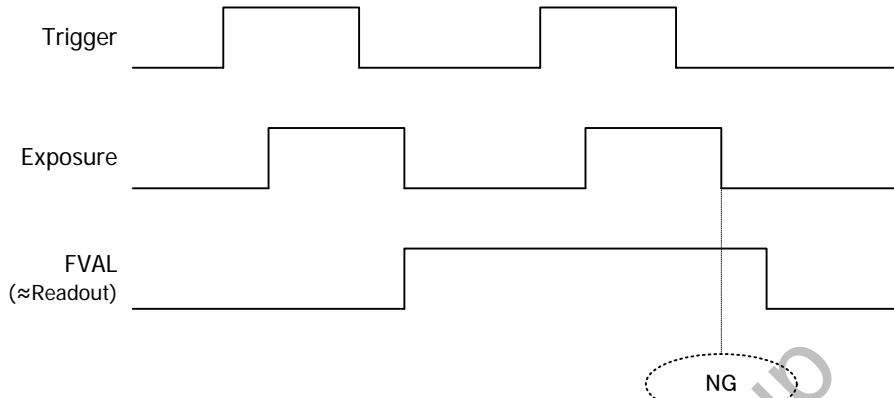

- If a trigger was input at the timing restricted as above or at the timing to end exposure right after FVAL became "L", video output from the camera would stop or would be all black.
- At normal operation mode, execute "SensorReset" command to recover such as when the camera stopped its operation, when proper images are not output, or when trigger input is stopped.
- When the camera stops operation or proper images are not output at sequence mode, stop trigger input, turn OFF SequenceActivation, and then execute "SensorReset" command to recover.

Device Control	
SensorReset	(Execute)

4.12.2.2 Trigger Pulse Input Timing and Exposure Start Delay Time

Please note that due to image sensor's own characteristics, the timing, for standard operation and overlapped operation, from when a trigger is input to the image sensor to when the actual exposure starts, would be different.

Trigger Input Timing and Exposure Start Delay time [μs]

	Link rate						
	CXP1_X4	CXP2_X4	CXP3_X4	CXP5_X4	CXP6_X1	CXP6_X2	CXP6_X4
Exposure Delay [μs] to start exposure for Standard operation ※Timing chart: Exposure delay time (A)	9.6	9.5	9.5	9.5	9.6	9.5	9.5
Exposure Delay [μs] to start exposure for overlapped operation ※Timing chart: Exposure delay time (B)	9.6~27	9.5~18	9.5~18	9.5~14	9.6~27	9.5~18	9.5~12

4.12.2.3 Fixed Trigger Shutter Mode

- This is the mode to start exposure by the input trigger signals. Exposure time is the set time with "Exposure Time".
- Set "TriggerSelectorAndActivation" to "FrameStartRisingEdge" or "FrameStartFallingEdge".
- Trigger cycle needs to be longer than FVAL period (Frame data reading out period).

- Trigger cycle needs to be longer than the exposure time.
- Trigger operation is CLK sync. H-V sync. reset.
- The trigger pulse width to be input is 30 us ~ Max. exposure time.
- The maximum exposure time depends on ROI setting, PixelFormat, and Link rate (Refer to the [Section 4.13. Exposure time](#)).

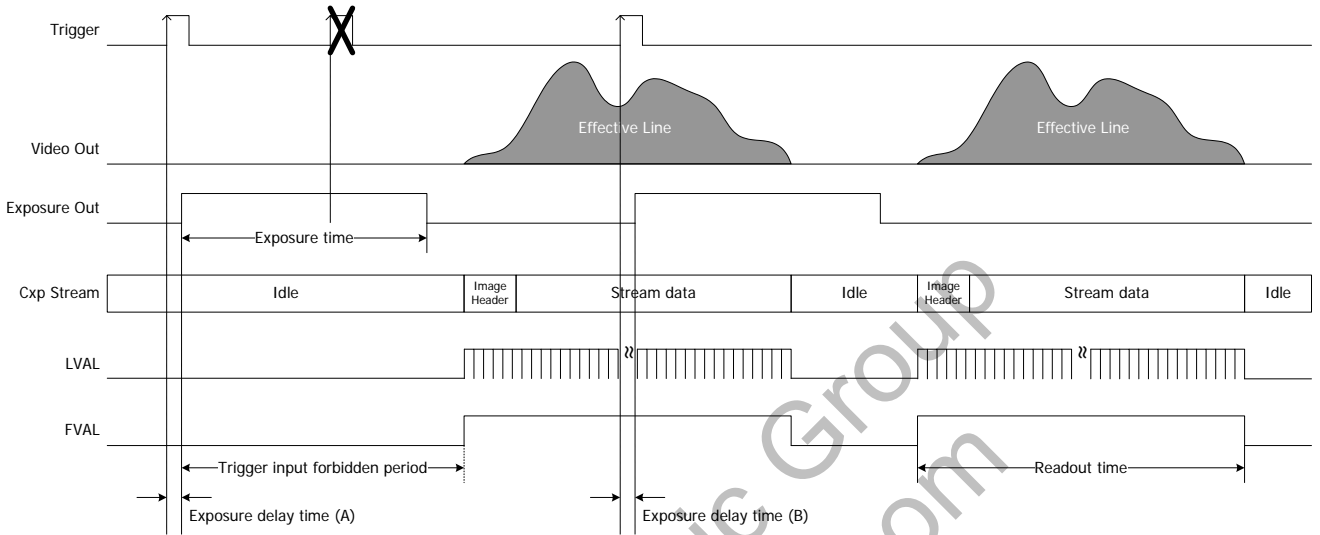

4.12.2.4 Pulse Width Trigger Shutter Mode

- This is the mode to start exposure by the input trigger signals. The exposure time is its trigger pulse width.
- Set "TriggerSelectorAndActivation" to "FrameStartLevelHigh" or "FrameStartLevelLow".
- Trigger cycle needs to be longer than FVAL period (Frame data reading out period).
- Trigger operation is CLK sync. H-V sync. reset.
- The minimum trigger pulse width to be input shall be 30µs. (Refer to the [Restrictions on trigger pulse input](#)).
- Functionally, there is no upper limitation. However, at long exposure, some noises, lines, pixel-wise FPN, and shading might be noticeable.

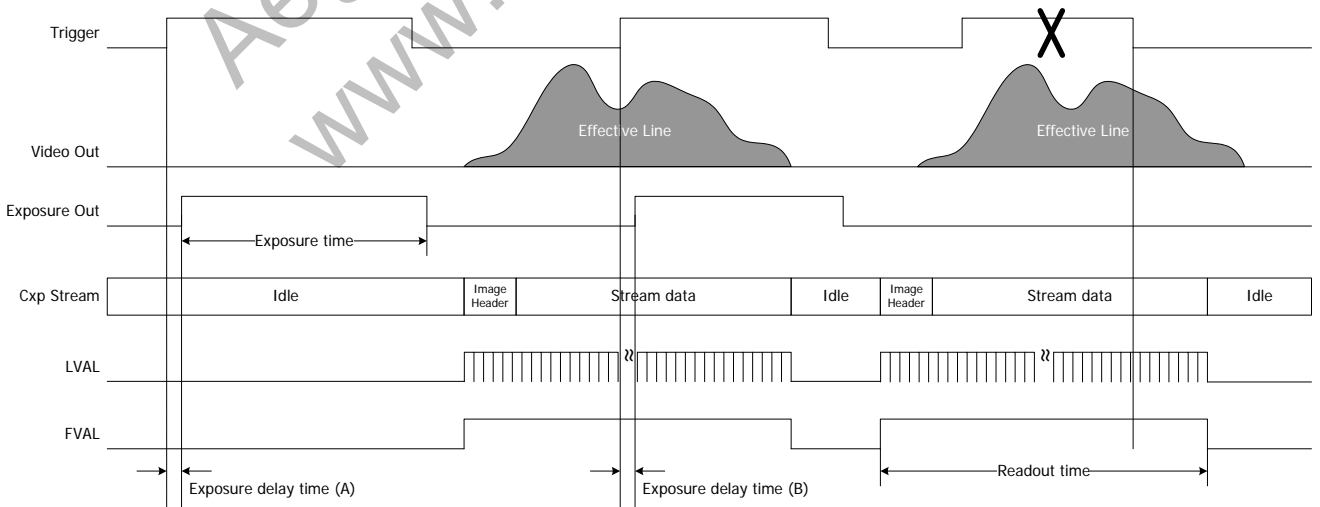

4.13. Exposure Time

Acquisition Control	
ExposureTime (us)	30~Max. exposure time
ExposureTimeMax	(ReadOnly)
PresetShutter1_Xs	(Execute)

◆ ExposureTime

Exposure time can be set per 1 μ s. The minimum exposure time is 30 μ s.

The maximum exposure time depends on ROI, "PixelFormat", and link rate. The smaller values than the chart below shall be set.

ROI setting mode (Video image size)	Known as	Pixel Format	Link rate				
			CXP1_X4	CXP2_X4	CXP3_X4	CXP5_X4	CXP6_X4
ROIQuickChangeOff (5120x5120)	25M	mono8	58026	32540	24689	14392	12060
		mono10	72590	36181	29354	18033	15132
ROIQuickChange4096x4096 (4096x4096)	16M	mono8	41642	22528	16156	11150	7793
		mono10	53475	25258	19797	12401	9784
ROIQuickChange4096x3072 (4096x3072)	12M	mono8	32540	17066	12515	8419	5916
		mono10	39822	18887	14336	9557	7452
ROIQuickChange3840x2896 (3840x2896)	10M	mono8	28899	15160	11320	7736	5461
		mono10	37091	16952	12999	8590	6883
ROIQuickChange3840x2160 (3840x2160)	4K QFHD	mono8	21617	11832	8192	6257	4096
		mono10	28444	12970	9557	7054	5176
ROIQuickChange2560x2048 (2560x2048)	5M	mono8	17976	8533	7964	5461	3868
		mono10	24348	10410	7964	5461	4949
ROIQuickChange2048x2048 (2048x2048)	4M	mono8	17066	7964	7907	5063	3868
		mono10	23438	8874	7907	5063	4949
ROIQuickChange1920x1440 (1920x1440)		mono8	12515	5688	5688	3868	2616
		mono10	16156	6144	5688	3868	3356
ROIQuickChange1920x1200 (1920x1200)	WUXGA	mono8	10695	4778	4778	3299	2275
		mono10	13425	5120	4778	3299	2958
ROIQuickChange1920x1080 (1920x1080)	Full HD	mono8	8874	4266	4266	2958	1934
		mono10	12515	4664	4266	2958	2503
ROIQuickChange1280x1024 (1280x1024)	SXGA	mono8	7964	3868	3868	2446	1820
		mono10	11605	4323	3868	2474	2446
Binning(Sum/Average) (2560x2560)		mono8	58026	32540	24689	14392	12060
		mono10	72590	36181	29354	18033	15132

ROI set mode (Video image size)	Known as	PixelFor mat	Link rate	
			CXP6_X1	CXP6_X2
ROIQuickChangeOff (5120x5120)	25M	mono8	58026	24689
		mono10	72590	29354
ROIQuickChange4096x4096 (4096x4096)	16M	mono8	41642	16156
		mono10	53475	19797
ROIQuickChange4096x3072 (4096x3072)	12M	mono8	32540	12515
		mono10	39822	14336
ROIQuickChange3840x2896 (3840x2896)	10M	mono8	28899	11320
		mono10	37091	12999
ROIQuickChange3840x2160 (3840x2160)	4K QFHD	mono8	21617	8192
		mono10	28444	9557
ROIQuickChange2560x2048 (2560x2048)	5M	mono8	17976	7964
		mono10	24348	7964
ROIQuickChange2048x2048 (2048x2048)	4M	mono8	17066	7907
		mono10	23438	7907
ROIQuickChange1920x1440 (1920x1440)		mono8	12515	5688
		mono10	16156	5688
ROIQuickChange1920x1200 (1920x1200)	WUXGA	mono8	10695	4778
		mono10	13425	4778
ROIQuickChange1920x1080 (1920x1080)	FullHD	mono8	8874	4266
		mono10	12515	4266
ROIQuickChange1280x1024 (1280x1024)	SXGA	mono8	7964	3868
		mono10	11605	3868
Binning (Sum/Average) (2560x2560)		mono8	58026	24689
		mono10	72590	29354

- ◆ ExposureTimeMax : The maximum exposure time

The settable maximum exposure time is indicated corresponding to ROI setting, "PixelFormat", and Link rate.

- ◆ PresetShutter1_Xs : Preset shutter value

When the preset shutter value is set, it shall be reflected to the long time exposure setting value.

PresetShutter1_Xs	Shutter (s)	Exposure time (μs)
Shutter_1_30s	1/30	33333 us
Shutter_1_50s	1/50	20000 us
Shutter_1_60s	1/60	16667 us
Shutter_1_100s	1/100	10000 us
Shutter_1_200s	1/200	5000 us
Shutter_1_500s	1/500	2000 us
Shutter_1_1000s	1/1000	1000 us
Shutter_1_2000s	1/2000	500 us
Shutter_1_5000s	1/5000	200 us
Shutter_1_10000s	1/10000	100 us
Shutter_1_30000s	1/30000	30 us

[Note]

- Shutter lines

The next exposure can be started while outputting video for the prior exposure (overlap). However, please note that there are some cases that shutter lines become noticeable depending on camera operational mode or gain settings used.

4.14. Gain

AnalogControl	
Gain	1.0~8.0
PresetGainX	(Execute)

- Gain : x1 to x8 preferred Gain can be set per x0.25.

[Note]

Functionally, gain up function is up to +8 times. However, the image quality will be reduced when gain setting is increased. We recommend you to evaluate it first.

- PresetGainX : Preset Gain

When the preset gain is set, it shall be reflected to manual gain.

Manual gain setting values would never be reflected to the preset values.

Preset values cannot be data saved.

PresetGainX	Magnification	Decibel equivalent
Gain_x1	x1	0dB
Gain_x2	x2	6.0dB
Gain_x3	x3	9.5dB
Gain_x4	x4	12.0dB
Gain_x5	x5	14.0dB
Gain_x6	x6	15.6dB
Gain_x7	x7	16.9dB
Gain_x8	x8	18.0dB

4.15. Black Level Adjustment

- This is the function to adjust black level.

AnalogControl	
BlackOffset	0~255

[Note]

- Black level is adjustable with relative values. When it is increased or decreased by 1, its luminance level changes by approx. 0.3 at 8 bit output, and it changes by approx. 1.2 at 10 bit output.
- When the lower values than the initial value are set, saturation level would not achieve to the maximum value for output range.
- At sequence control mode, black level shall be adjusted to the deepest black.
- The black level of this model, "VCC-25CXP1MBN" shall be changed depend on usage environment (ambient temperature, gain, output image size, and link speed). We recommend you to adjust black level by "BlackOffset" to set the proper black level.

4.16. Shading Correction

- This is a function to correct the peripheral brightness lowering caused by the lens and others used.

AnalogControl	
ShadingCorrectionDataSelector	Table1/Table2/Table3
ShadingCorrection	True/False
DetectShading	(Execute)

- ◆ ShadingCorrectionDataSelector : This is to select shading correction data.
3 types of shading correction data table at ShadingCorrection or DetectShading can be selected.
- ◆ ShadingCorrection
Turn ShadingCorrection True to start shading correction according to the shading correction data prepared by the table of shading detection selected by ShadingCorrectionDataSelector.

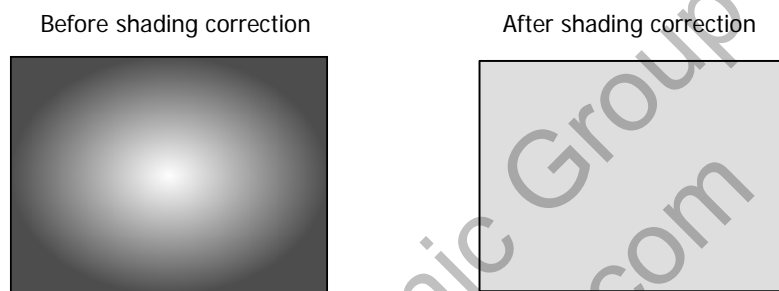

- ◆ DetectShading : Shading detection
Shoot a uniform object such as a pattern box, to full screen, then execute DetectShading, to calculate and save the shading correction data of the table selected by ShadingCorrectionDataSelector automatically in the camera.

[Note]

- ◆ Turn ShadingCorrection False to change the table of shading correction data.
- ◆ Turn ShadingCorrection False to detect shading.
- ◆ When detecting shading, make sure to turn OFF partial scan mode (ROI) and binning. (The image size shall be set to 5120×5120 to execute.)
- ◆ When changing ReverseY, please re-execute shading detection.
- ◆ Acquire correction data only when the camera is in operation. (Shading correction data cannot be acquired if the camera is not outputting anything).
- ◆ Execute UserSetSave to save the correction data of Table1~Table3 to the non-volatile memory at the same time.
- ◆ Execute UserSetDefault to delete the entire correction data of Table1~Table3.
- ◆ ShadingCorrection cannot be changed if the BinningMode is set to other than OFF after setting ShadingCorrection "TRUE". Please turn OFF BinningMode first to change ShadingCorrection.
- ◆ When obtain correction data with trigger shutter mode, the data sometimes becomes unstable. In this case, change the trigger cycle in small measure and obtain correction data again.

4.17. Defective Pixels Correction

- This is a function to detect, add, and correct the defective pixels included in the output data from the sensor.
- Defective pixels data are categorized into two types and controlled.
 - Defective pixels correction at ex-factory
The detected data of white pixel defects and black pixel defects detected at ex-factory are saved. Basically, these data cannot be deleted.
 - Defective pixels correction data registered by users
Data increased after shipment or any preferred data can be added and corrected by users. These data can be deleted by DefectPixelDefault. These data cannot be initialized by UserSetDefault.
 - Defective pixels correction data
The definition of defective pixels correction data is the type of defect showed in the coordinate data of DefectPixelOffsetX, DefectPixelOffsetY and DefectPixelType below.
- The number of data registerable by users is 1024 points. However, by combining ex-factory data and data registered by users, 128points can be registered for each CH.

[CH (Channel)]

Images are processed by 16CH interleave in the camera.

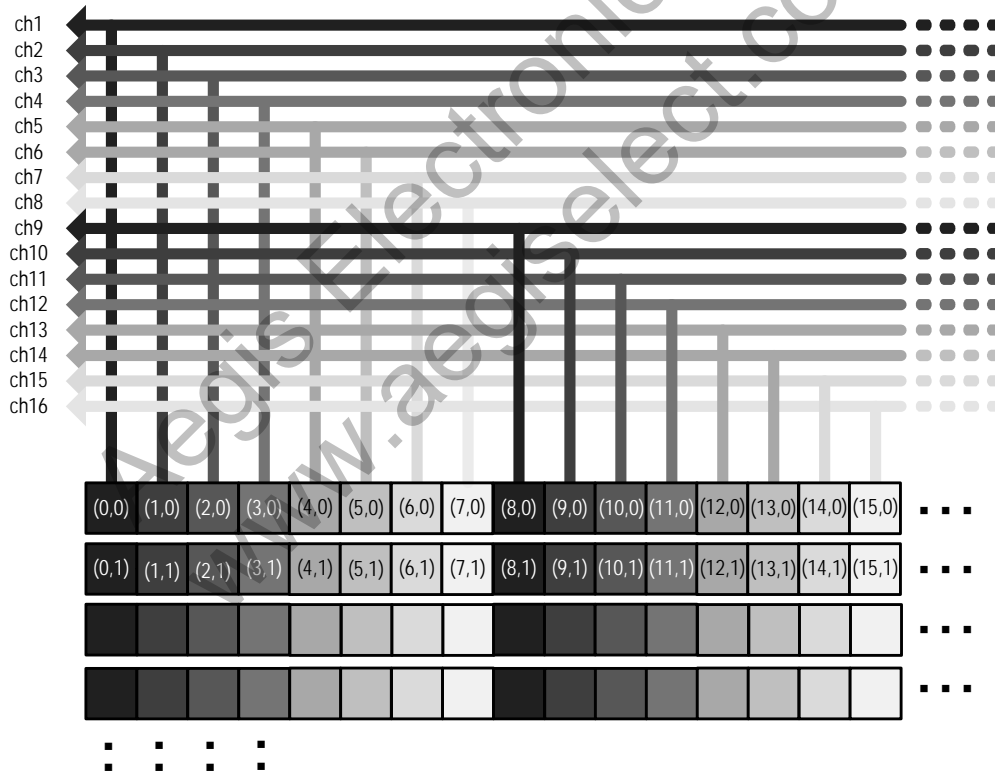

- Defective pixels
This is to select ON/OFF of defective pixels correction processing.
Data at Ex-factory and data registered by users are both controlled at the same time.

AnalogControl	
DefectivePixelCorrection	True/False

□ Defective pixels detection registered by users

This is to detect and register the correction data of white defect caused by the image sensor.

AnalogControl	
DefectDetectionThresholdValue	0~1023
DefectDetection	(Execute)
DefectDetectionStatus	(ReadOnly)
DefectPixelDefault	(Execute)

- ◆ DefectDetectionThresholdValue : This is to set the threshold value (0~1023: 10bit equivalent) of defective pixels detection registered by user.
The data with luminance level more than the specified level here shall be registered.
※ 4times more value of the image signal level shall be specified as the threshold value with 8 bit images.
This shall not be initialized by DefectPixelDefault. Please execute UserSetDefault to initialize.
- ◆ DefectDetection : This is to detect the defective pixels registered by user.
This is the function to register the pixels automatically if a pixel exceeds the level specified at DefectDetectionThresholdValue. Please be noted that no lights should be in the sensor surface to use this function.
The defective pixels correction registered by user shall be reflected right after the execution.
In case UserSetSave is executed after defective pixels detection registered by user, the data will be saved in non-volatile memory.
- ◆ DefectDetectionStatus : This is to indicate the result of the defective pixels correction detection registered by user.

0	None defective pixels correction data registered by user
Value (1024 or less)	At normal operation (Detected number of defective pixels registered by users)
0x000e0001	Sum total of the defective pixels data exceeds the maximum number registerable in one CH.
0x000e0002	Sum total of the defective pixels data exceeds the maximum number (1024 points) registerable.
0x000e0003	Error other than above.

If the 1025 points or more is indicated, please check the threshold value (DefectDetectionThesholdValue) of defective pixels detection registered by user is proper. Also, please confirm DefectivePixelCorrection as well.

- ◆ DefectPixelDefault : This is to delete entire defective pixels correction data registered by users and initialize DefectDetectionStatus.

[Note]

- ◆ Correction data shall be acquired only when the camera is in operation. When camera is not outputting anything, white defect detection cannot be performed.
- ◆ When detecting defective pixels, custom ROI mode, binning, ReverseX, ReverseY, sequence, and shading shall be OFF. (Size shall be set to 5120x5120)
- ◆ When changing the threshold value of DefectDetectionThresholdValue and acquiring the defective pixels correction data registered by users, please execute DefectPixelDefault and delete the defective pixels correction data registered by user to reacquire it. The value of DefectDetectionThresholdValue shall not be changed. Please specify it separately.

- ♦ The registerable number of defective pixels and the correctable number of defective pixels may not be always the same because of the following reasons.
 - (1) With white defects detection, if one of the strip read reached the maximum number, correction could not be performed. In such case, the data up to that point are registered, error is output, and operation ends.
 - (2) If no effective pixel exists up next, down next, right next, or left next to the pixel to be corrected, this pixel can be registered but cannot be corrected.



When X1, X2, X3, and X4 are already registered as defective pixels, X can be added to be registered but it cannot be corrected.

□ Defective Pixels Indication

The coordinate of defective pixels registered by users can be indicated.

AnalogControl	
RegisteredDefectSelector	UserState/InitialState
DefectPixelNumber	1~1024
DefectPixelOffsetX	(ReadOnly)
DefectPixelOffsetY	(ReadOnly)
DefectPixelType	(ReadOnly)

- ♦ RegisteredDefectSelector : This is to select the type of defect registered.
- ♦ DefectPixelNumber : This is to set the number to the registered defect. (1~1024)
The table number of the defect data at ex-factory and the defect registered by user shall be specified.
- ♦ DefectPixelOffsetX : This is to indicate the X coordinate of the defect specified at DefectPixelNumber.
8191 shall be indicated when the number of the table does not have any defect data.
- ♦ DefectPixelOffsetY : This is to indicate the Y coordinate of the defect specified at DefectPixelNumber.
8191 shall be indicated when the number of the table does not have any defect data.
- ♦ DefectPixelType : This is to indicate the defect type specified at DefectPixelNumber.
 - 0: Not registered
 - 1: White defect at ex-factory
 - 2: Black defect at ex-factory
 - 6: White defect registered by users

AnalogControl	
ChannelNumber	0~15
DefectPixelChannelCount	(ReadOnly)

- ♦ ChannelNumber: This is to specify the channel number of defect processing.
- ♦ DefectPixelChannelCount: This is to indicate the number of defects of channel number specified at ChannelNumber. The specified number of the defect of the channel number is the sum total of the defects at ex-factory and the number of defects registered by user.

4.18. Link Speed and Link Count

Transfer Control	
ConnectionConfig	CXP1_X4
	CXP2_X4
	CXP3_X4
	CXP5_X4
	CXP6_X4

- ◆ CXP1_X4 : Link speed=1.250Gbps, Link count=4
- ◆ CXP2_X4 : Link speed=2.500Gbps, Link count=4
- ◆ CXP3_X4 : Link speed=3.125Gbps, Link count=4
- ◆ CXP5_X4 : Link speed=5.000Gbps, Link count=4
- ◆ CXP6_X4 : Link speed=6.250Gbps, Link count=4

4.19. How to Save and Initialize the Settings

- If you wish to save the setting values, execute UserSetSave. Doing so, the setting values shall be saved in the camera non-volatile memory and the saved settings data shall be reflected when the camera is turned on next time.

UserSets	
UserSetSave	(Execute)
UserSetDefault	(Execute)

- ◆ UserSetSave : This is to save the setting values of the camera.
 - ◆ UserSetDefault : This is to restore the camera setting values to the ex-factory settings.
- When executing "UserSetDefault", set ConnectionConfig to "CXP3_X4" to execute.
 - Camera settings shall be restored to the factory settings right after completion of UserSetDefault. However, there would be some cases that command indications are not updated depending on its indication software used. Please make sure to update the command.

4.20. Sequence Control Function

- This is the function to select one set of parameter out of the several preset parameter sets per every trigger input, and apply it to the camera.
- The maximum 16 kinds of parameter sets can be preset. The following parameters can be set per each set.
Settable parameter: Shutter, Gain, Start X coordinate, Start Y coordinate, X size, and Y size
- Operation sequence is specified as "Index". This is to specify the parameter set number applying to the maximum 16 indexes.
- There are three control modes; trigger mode, burst mode, and index mode.

4.20.1 Basic Operation for Sequence Control Function

- Please follow the below steps to use sequence control function.
 - (1) Trigger shutter mode

AquisitionControl -- According to TriggerSelectorAndActivation, select trigger type and polarity out of the followings, corresponding to the sequence operation.
FrameStartRisingEdge/ FrameStartFallingEdge/ FrameStartLevelHigh/ FrameStartLevelLow/
FrameBurstStart
 - (2) Defective pixels correction, binning, and ROI settings

Turn "False" DefectivePixelCorrection, and turn "OFF" BinningMode. This function cannot be used with sequence control function. Set the ROI of ImageFormatControl to ROIQuickChangeOff.
 - (3) Selection of the maximum ROI size

Select SequencerMaxROIsize bigger than the maximum X and Y size of the one for the parameter set to be used for sequence control.
 - (4) Set the maximum 16 sets of parameter table for sequence to be used.
 - (5) Make sure to turn OFF sequence operational mode (SequencerControl – SequencerActivation), and select the following settings.

In case of Trigger mode and Burst mode: Select OFF → FrameStartPredefined
In case of Index mode: Select OFF → FrameStartIndexSelector
 - (6) Input a trigger pulse to start sequence control operation.

In case of burst mode, it stops at the last image screen of sequence when sequence control is completed.
 - (7) Turn OFF SequenceActivation to get back to the status before sequence control.

- Restrictions on trigger pulse input timing

Restrictions on trigger input timing at sequence control are the same as the one for normal mode.
In case of Index mode, input trigger signals when Ack is returned after IndexSelectorModeIndexNumber setting is completed.

[Note]

- ♦ SequencerActivation shall be turned OFF once, before setting settings for sequence.
- ♦ With SequencerActivation, UserSetSave is not valid, therefore, set them manually after turning power ON.
- ♦ Sequence starts when SequencerActivation was set to other than OFF, if a trigger had been input in the camera. Make sure not to input any triggers when changing SequencerActivation.
- ♦ Exposure time to input for each parameter shall be smaller values than the specified values in [Section 4.13. The Maximum Exposure Time](#), according to SequencerMaxROIsize and link rate to be used.
- ♦ Sequence may stop with unstable status if operation for normal mode were performed while sequence control is in operation. Please make sure to turn OFF Sequence operation to proceed.

4.20.2 Trigger Mode and Burst Mode Operational Outline

- This is the mode to specify Index transition flow in advance.
The repeating count for each Index, the number of the Index to use, and loop count can be set.
- Trigger mode
The repeating count of Index shall be added every time when the external trigger is input, and the specified parameter set shall be applied to the camera.
- Burst mode
It operates as the same way as free run at internal sync. mode. Sequence starts with the trigger, and the repeat count of Index shall be added automatically by the camera internal trigger, then its parameter set is applied to the camera.

□ Operational flow

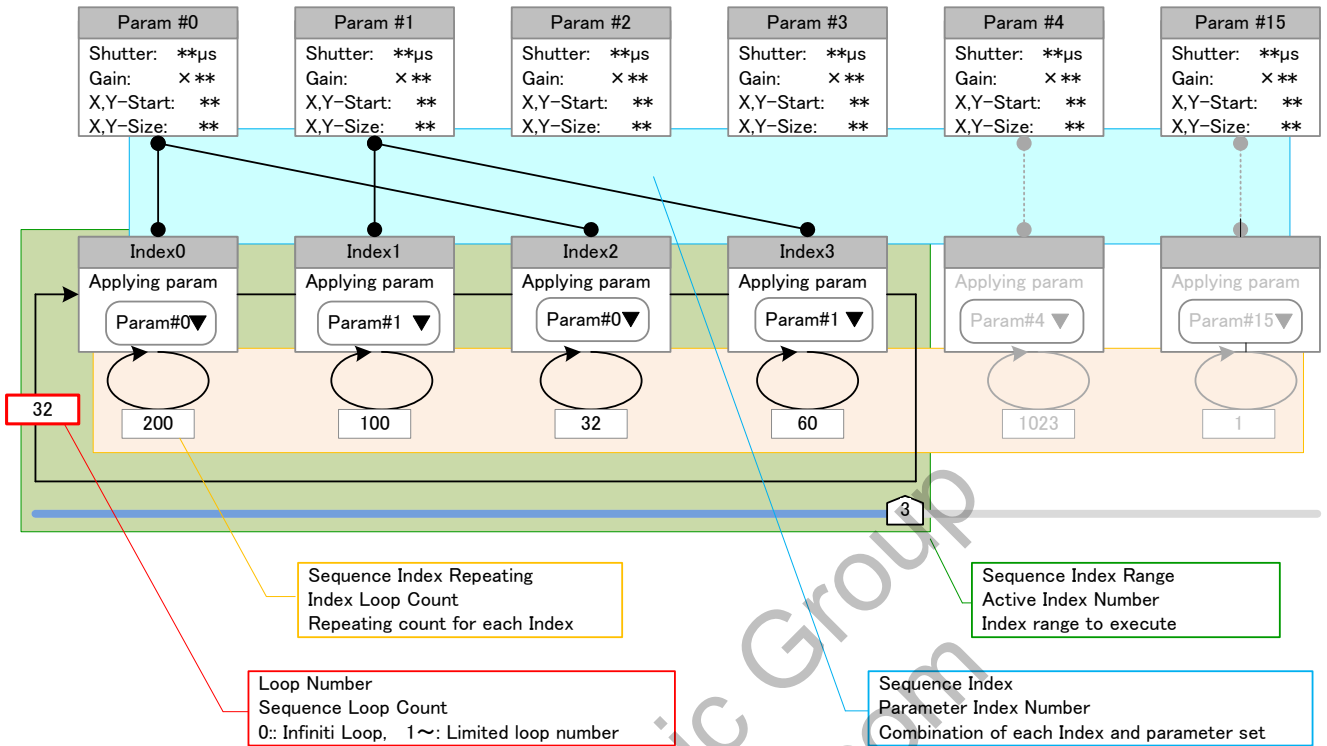

4.20.3 Trigger Mode

- The start and stop of sequence operation can be controlled by the edge control or pulse width control of trigger input signals.
- Set TriggerSelectorAndActivation to the one out of FrameStartRisingEdge/ FrameStartFallingEdge/ FrameStartLevelHigh/ FrameStartLevelLow to use. Repeat count, Index number, and Loop count can be set for each Index.

(1) Edge control

- Sequence starts with a trigger input when TriggerSelectorAndActivation is FrameStartRisingEdge or FrameStartFallingEdge.
- Exposure time (① and ②) for each frame shall be controlled by the preset sequence parameter set.
- When the image output for the sequence Loop count is completed, sequence operation ends.

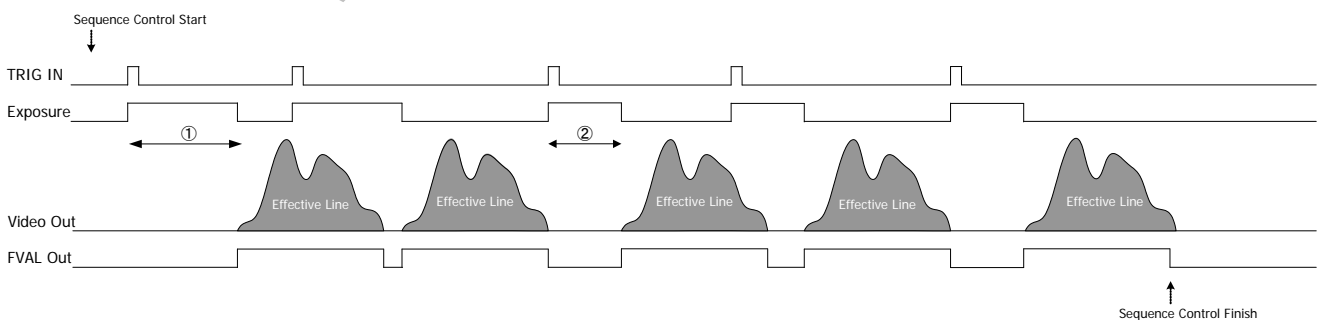

(2) Pulse width control

- Sequence starts with a trigger input when TriggerSelectorAndActivation is FrameStartLevelHigh or FrameStartLevelLow.

- Exposure time (①) and (②) for each frame is the pulse width of the trigger.
- When the image output for the sequence loop count is completed, sequence operation ends.

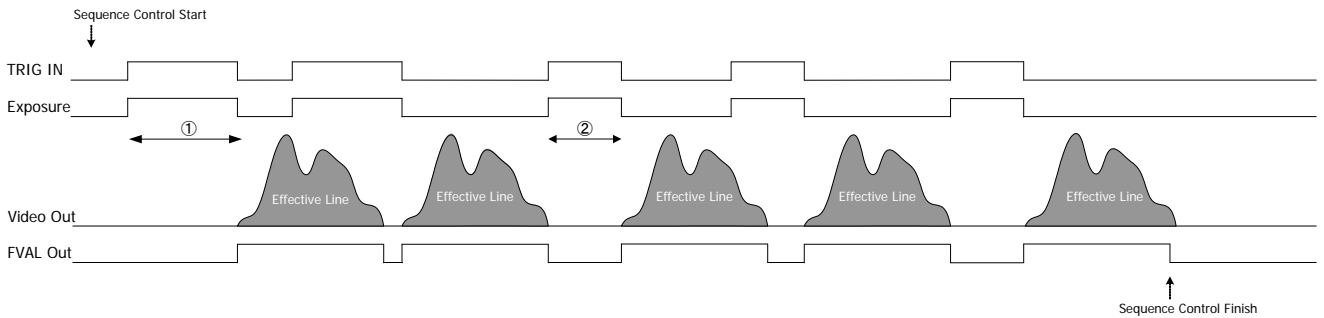

4.2.0.4 Burst Mode

- The start and stop of sequence operation can be controlled by the edge control or level control of trigger input signals, and register start.
- Set TriggerSelectorAndActivation to FrameBurstStart.

(1) Edge control

- Sequence starts with a trigger input when SequencerActivation is FrameBurstStartEdge.
- Exposure time for each frame (①) and frame output time (②) shall be controlled by the preset sequence parameter set and its image size setting.
- When the image output for the sequence loop count is completed, sequence operation ends.

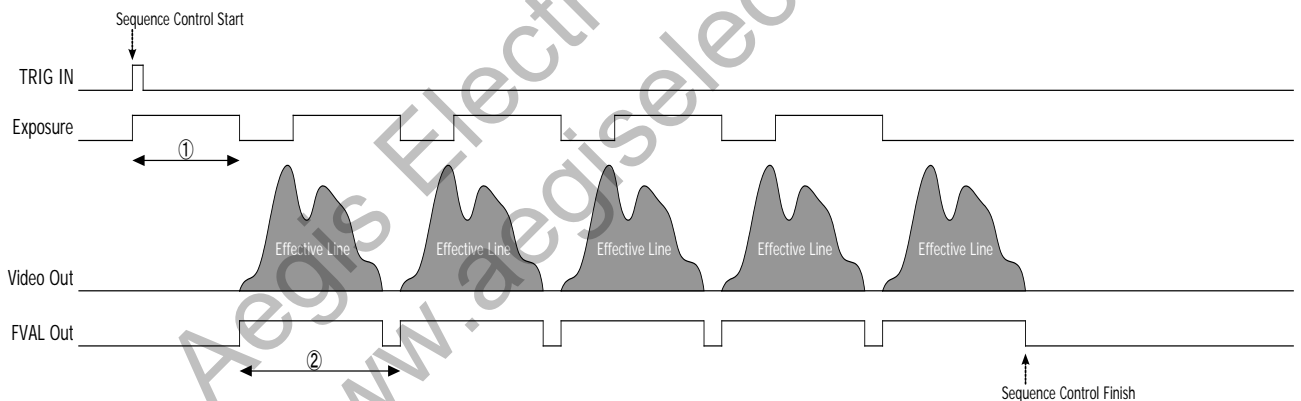

(2) Level control

- In case of SequencerActivation is FrameBurstStartLevel, sequence operation shall be executed while the trigger input is High level.
- Sequence operation can be paused by changing the trigger input to Low level. If you wish to end Sequence operation, turn OFF TriggerSelectorAndActivation.
- By changing the trigger input to High level while pausing, Sequence operation can be resumed.
- When the image output for the sequence Loop count is completed, sequence operation ends.

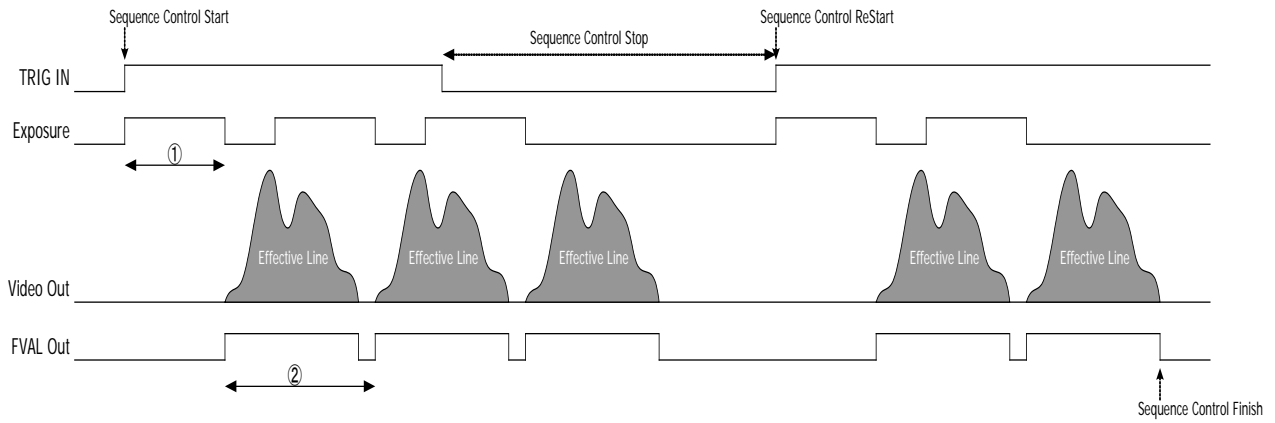

(3) Register start

- In case of SequencerActivation is FrameBurstStartSoftware, the same sequence operation as edge control shall be executed by TriggerSoftware.

4.20.5 Index Mode

- This is the mode to directly specify the Index number to apply by IndexSelectorModeIndexNumber.
- Every time when a trigger is input, the Index parameter set specified by IndexSelectorModeIndexNumber is applied to the camera.
- Set TriggerSelectorAndActivation to the mode to be used out of FrameStartRisingEdge/ FrameStartFallingEdge/ FrameStartLevelHigh/ FrameStartLevelLow
- Operational Flow

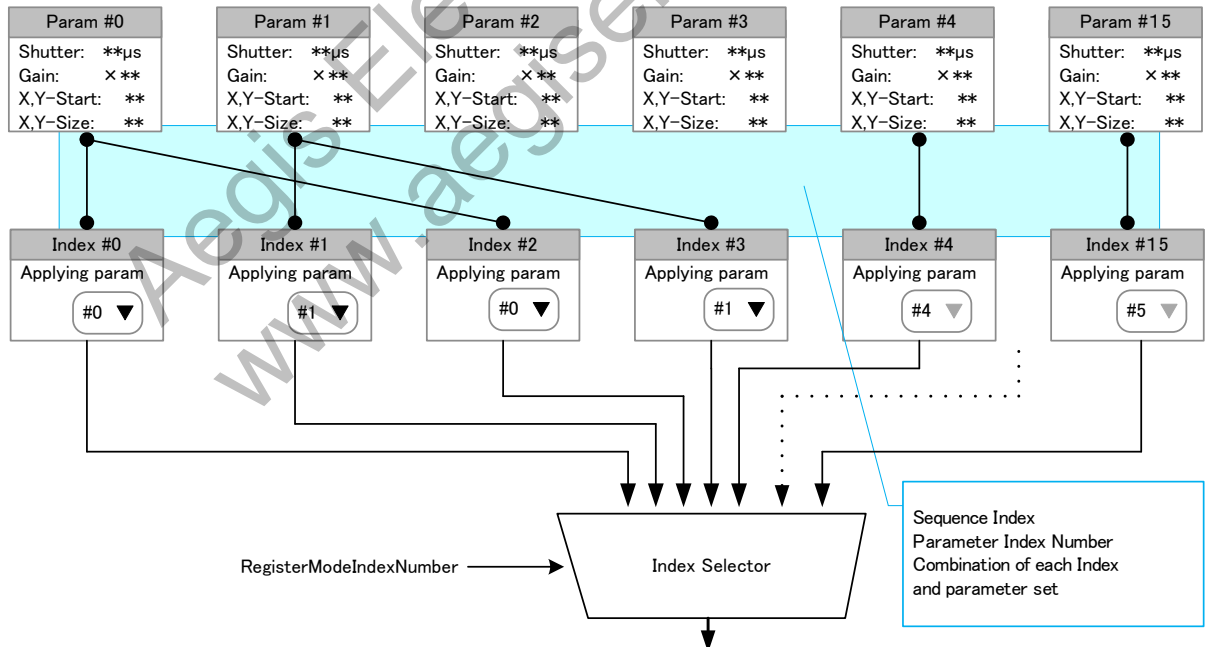

(1) Edge Control

- Exposure time for each frame shall be controlled by the preset sequence parameter set.

(2) Pulse Width Control

- Trigger Pulse Width becomes exposure time for each frame. Exposure time of the parameter set is not referred.

4.20.6 Setting for Sequence Control

- Execute UserSetSave to save the settings. SequencerActivation is not saved so that it will always be OFF when power is turned ON. Settings shall be set every time when using Sequence mode.
- How to set Sequence Control Settings.

Acquisition Control	
TriggerSelectorAndActivation	AquisitionMode FrameStartRisingEdge FrameStartFallingEdge FrameStartLevelHigh FrameStartLevelLow FrameBurstStart

- FrameStartRisingEdge : Set sequence control to the rising edge control of the trigger pulse.
- FrameStartFallingEdge : Set sequence control to the falling edge control of the trigger pulse.
- FrameStartLevelHigh : Set sequence control to the high level control of the trigger pulse.
- FrameStartLevelLow : Set sequence control to the low level control of the trigger pulse.
- FrameBurstStart : Set sequence control to use at burst mode.

- Settings for Sequence Mode Start

SequencerControl	
SequencerActivation	OFF FrameStartPredefined FrameStartIndexSelector FrameBurstStartEdge FrameBurstStartLevel FrameBurstStartSoftware

- SequencerActivation : Set sequence control mode.
- FrameStartPredefined : Set to start trigger mode.
- FrameStartIndexSelector : Set to start index mode.
- FrameBurstStartEdge : Set to start burst mode with edge control.
(Selectable at FrameBurstStart).
- FrameBurstStartLevel : Set to start burst mode with level control.
(Selectable at FrameBurstStart).
- FrameBurstStartSoftware : Set to start burst mode with register start.
(Selectable at FrameBurstStart).

- Settings for Sequence Count and Range

SequencerControl	
ActiveIndexNumber	0~15

- ActiveIndexNumber : Specify the Index number to return at trigger mode and burst mode.

SequencerConfigurationParameter	
ParameterIndexNumber	
Index0	Parameter number of Index0
Index1	Parameter number of Index1
Index2	Parameter number of Index2
Index3	Parameter number of Index3
Index4	Parameter number of Index4
Index5	Parameter number of Index5
Index6	Parameter number of Index6
Index7	Parameter number of Index7
Index8	Parameter number of Index8
Index9	Parameter number of Index9
Index10	Parameter number of Index10
Index11	Parameter number of Index11
Index12	Parameter number of Index12
Index13	Parameter number of Index13
Index14	Parameter number of Index14
Index15	Parameter number of Index15

- Specify the parameter number to execute for Index 0 to 15.

SequencerConfigurationParameter	
IndexLoopCount	
IndexCount0	Parameter number of Index0
IndexCount1	Parameter number of Index1
IndexCount2	Parameter number of Index2
IndexCount3	Parameter number of Index3
IndexCount4	Parameter number of Index4
IndexCount5	Parameter number of Index5
IndexCount6	Parameter number of Index6
IndexCount7	Parameter number of Index7
IndexCount8	Parameter number of Index8
IndexCount9	Parameter number of Index9
IndexCount10	Parameter number of Index10
IndexCount11	Parameter number of Index11
IndexCount12	Parameter number of Index12
IndexCount13	Parameter number of Index13
IndexCount14	Parameter number of Index14
IndexCount15	Parameter number of Index15

- Specify the repeating count for each Index (1~1023).

SequencerConfigurationParameter	
SequencerLoopCount	Loop count of Sequence
IndexSelectorModeIndexNumber	Index number to execute

- SequencerLoopCount : Specify the loop count to execute (0~1023) at burst mode.
"0" is infinity loop.
- IndexSelectorModeIndexNumber : The specified Index here shall be infinity loop at Index mode.

□ Settings for Sequence Parameter Set

- 16 parameter sets are prepared. By changing the number of SequencerParameterSetSelector, parameter set will be replaced. Even if the parameter number is changed, the set data can be saved.

SequencerControl	
PatameterSetSettingNumber	Parameter number
PatameterSetSettingNumber	
SequencerExposureTime	Exposure time
SequencerGain	Gain
SequencerWidth	Size of X direction
SequencerHeight	Size of Y direction
SequencerOffsetX	Offset of X direction
SequencerOffsetY	Offset of Y direction

- PatameterSetSettingNumber : Specify the number of parameter and set the next parameter (0~15).
- SequencerExposureTime : Set exposure time for each parameter.
- SequencerGain : Set Gain for each parameter.
- SequencerWidth : Set the size of X direction for each parameter.
- SequencerHeight : Set the size of Y direction for each parameter.
- SequencerOffsetX : Set the offset of X direction for each parameter.
- SequencerOffsetY : Set the offset of Y direction for each parameter.

[Note]

The input value of SequencerWidth, SequencerHeight, SequencerOffsetX, and SequencerOffsetY are limited to the size of SequencerMaxROISize. Please input SequencerWidth, SequencerHeight, SequencerOffsetX, and SequencerOffsetY after setting SequencerMaxROISize.

SequencerControl	
SequencerMaxROISize	ROISize_5120x5120
	ROISize_4096x4096
	ROISize_4096x3072
	ROISize_3840x2896
	ROISize_3840x2160
	ROISize_2560x2048
	ROISize_2048x2048
	ROISize_1920x1440
	ROISize_1920x1200
	ROISize_1920x1080
ROISize_1280x1024	
SequencerMaxExposureTime	(ReadOnly)

- SequencerMaxROISize : Select bigger size of SequencerMaxROISize than the maximum X size and Y size of the parameter set to use for Sequence control.
- SequencerMaxExposureTime : It shows the maximum exposure time which can be used with the selected SequencerMaxROISize. Exposure time for each parameter shall be set lower than this value.

4.20.7 Sequence Status Information

- Indicates the status of Sequence control.

SequencerStatus	
IndexNumberStatus	(ReadOnly)
RepeatNumberStatus	(ReadOnly)
LoopNumberStatus	(ReadOnly)
FrameBurstStatus	(ReadOnly)

- IndexNumberStatus : Indicate the Index number in execution.
- RepeatNumberStatus : Indicate the Index repeating number in execution.
- LoopNumberStatus : Indicate the sequence loop number in execution.
- FremeBurstStatus : Indicate the sequence status of burst mode.

- Image output of sequence status

While sequence operation, the sequence status information can be embedded to output.

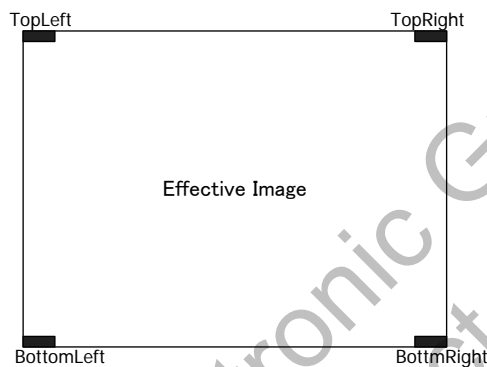

SequencerControl		
SequencerInformationLocation	Off	None
	TopLeft	Upper Left 5pixel
	TopRight	Upper Right 5pixel
	BottomLeft	Lower Left 5pixel
	BottomRight	Lower Right 5pixel

- SequencerInformationLocation : Specify the pixel position to embed the sequence status information.

- For each pixel, index number, index repeating number, and loop count are output as follows.

In case of Mono10 MSB ← 10bit → LSB

In case of Mono8 MSB ← 8bit → LSB

pix0	Index number [3:0]	"0000"	"00"
pix1	Repeating No. [7:0]		"00"
pix2	"000000"	Repeating count [9:8]	"00"
pix3	Loop count[7:0]		"00"
pix4	"000000"	Loop count[9:8]	"00"

5. Factory Settings

Function	Data	Explanation
DeviceUserID	DeviceUserID	
DeviceIndicatorMode	Active	
Width	5120	
Height	5120	
OffsetX	0	
OffsetY	0	
BinningMode	Off	
ReverseX	False	
ReverseY	False	
PixelFormat	Mono8	
ValidDataSelector	Upper8bit	
ShowCursor	Off	
CursorX	0	
CursorY	0	
CursorColor	White	
TestPattern	Off	
TriggerSelectorAndActivation	AcquisitionMode	
TriggerSource	LinkTrigger0	
ExposureTime	30.000	
Gain	1.000	
BlackOffset	10	
ShadingCorrectionDataSelector	Table1	
ShadingCorrection	False	
DefectivePixelCorrection	True	
DefectDetectionThresholdValue	0	DefectDetectionThresholdValue
RegisteredDefectSelector	UserState	RegisteredDefectSelector
DefectPixelNumber	1	DefectPixelNumber
ChannelNumber	0	ChannelNumber
ConnectionConfig	CXP6_X1	
SequencerMaxROISize	ROISize_5120x5120	
SequencerInformationLocation	Off	
ActiveIndexNumber	0	
SequencerActivation	Off	
Index0~Index15	0~15	The same value as the Index number
Index0Count~Index15Count	1	All 1
SequencerLoopCount	0	
IndexSelectorModeIndexNumber	0	
ParameterSetSettingNumber	0	
SequencerExposureTime	30.000	
SequencerGain	1.000	
SequencerWidth	5120	
SequencerHeight	5120	
SequencerOffsetX	0	
SequencerOffsetY	0	

※ Factory settings shall be the same values as the one for UserSetDefault command.

6. Dimensions

6.1. Camera Dimensions

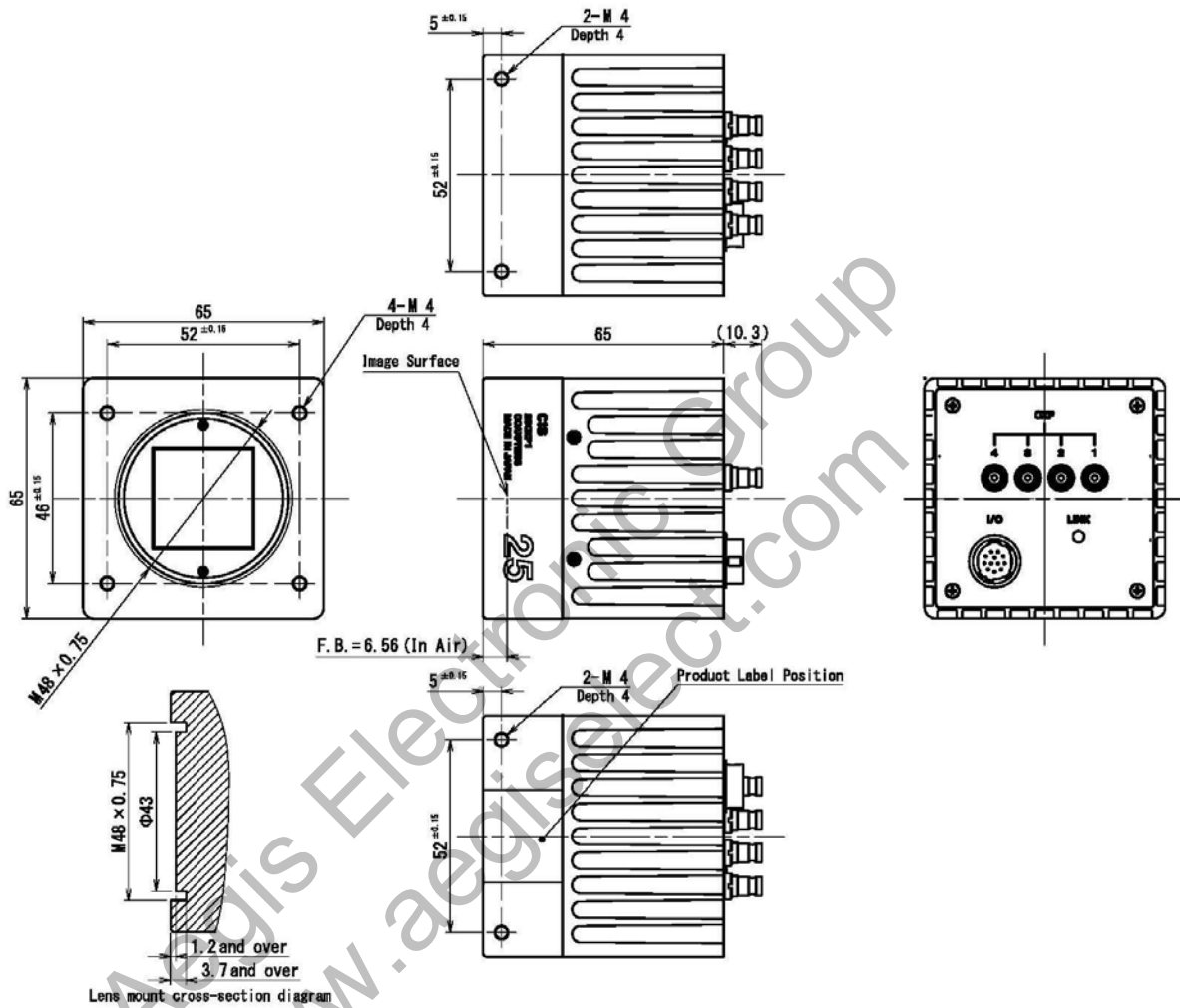

Note 2) Lens mount screw complies with M48×0.75-6H. Please refer to J11A LE-004-2011.
 Note 1) Please make sure the protrusion portion does not interfere with the lens selected.
 Refer to the lens mount cross-section diagram for the details.

935-0042-00
 (Unit:mm)

6.2. CMOS Optical Axis Accuracy

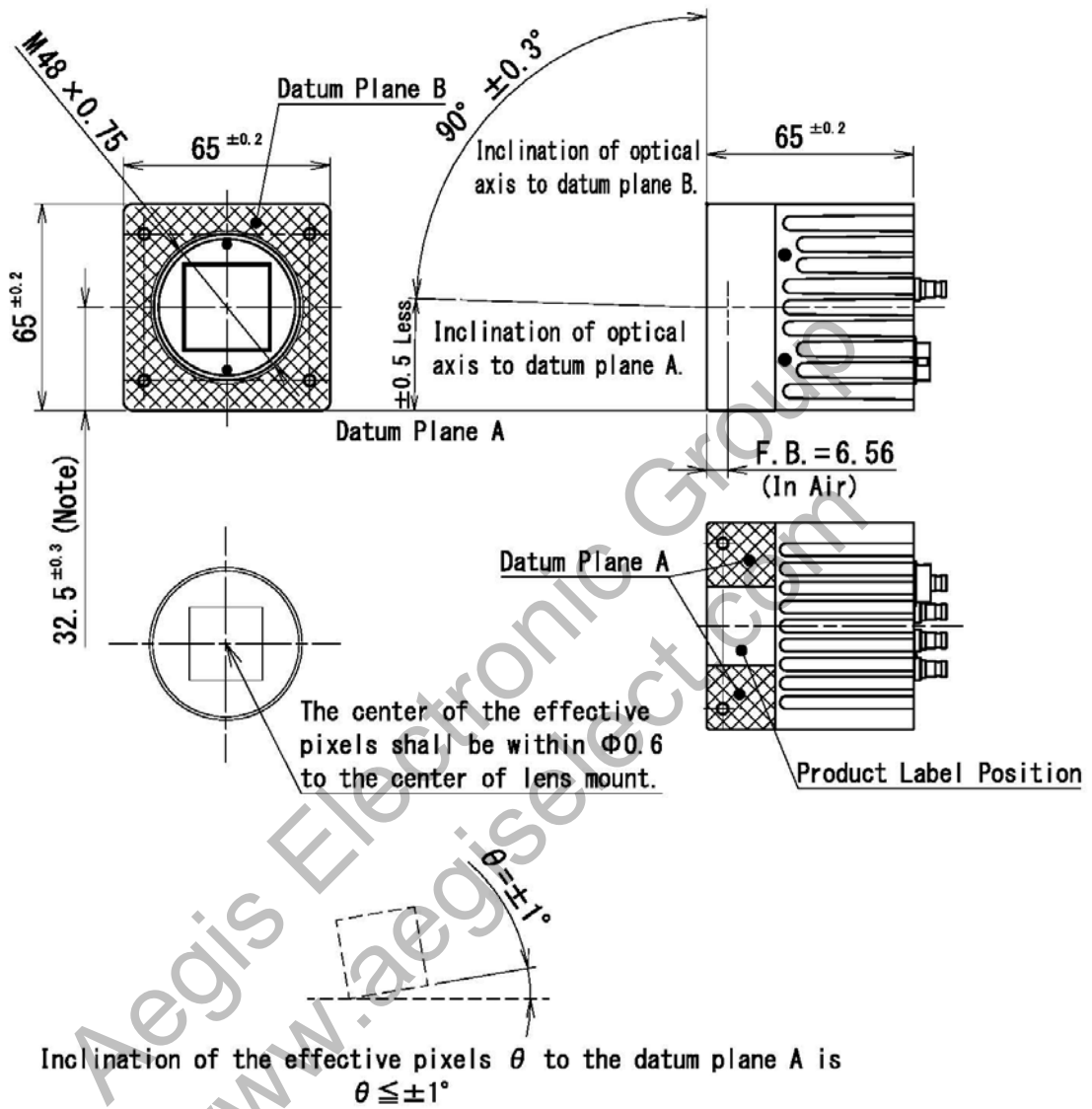

Note : Dimensions from datum plane A to the center of the lens mount.

937-0013-00
(Unit : mm)

7. Case for Indemnity (Limited Warranty)

7.1. Product Warranty

The term of warranty of this product is within 3 years from the date of shipping out from our factory.

If you use the product properly and discover a defect during the warranty period, and if that was caused by designing or manufacturing, CIS Corporation, at its option, repairs or replaces it at no charge to you. Products out of warranty period will be subject to charge. CIS repairs the products as long as it is repairable.

CIS shall be exempted from taking responsibility and held harmless for damages or losses incurred by the following cases.

- In case damages or losses are caused by earthquake, lightning strike, fire, flood, or other acts of God.
- In case damages or losses are caused by deliberate or accidental misuse by the user, or failure to observe the information contained in the instructions in this Product Specification and Operational Manual.
- In case damages or losses are caused by repair or modification conducted by the customer or any unauthorized party.

7.2. CMOS Pixel Defect

CIS compensates the noticeable CMOS pixel defects found at the shipping inspection prior to our shipment. On very rare occasions, however, CMOS pixel defects might be noted with time of usage of the products. Cause of the CMOS pixel defect is the characteristic phenomenon of CMOS sensor itself and CIS is exempted from taking any responsibilities for them. Should you have any questions on CMOS pixel defects compensation please contact us.

7.3. Product Support

Should you have any problems in function of the product you purchased, and if you need our further analysis and/or repair, please contact the dealer you purchased it from.