

CIS

CoaXPress I/F
1.3M SWIR Camera

VCC-SXCXP1SW

Product Specifications
& Operational Manual

CIS Corporation

Table of Contents

1.	Precautions.....	1
1.1.	Handling Precautions	1
1.2.	Restrictions on Applications	1
1.3.	Disclaimers (Exception Clause).....	1
1.4.	Image Quality Limitations	1
2.	Product Outline	2
2.1.	Features.....	2
2.2.	Accessories	2
3.	Specifications	3
3.1.	General Specifications	3
3.2.	Input and Output Specifications	5
3.2.1	12pins Circular Connector No.11 pin: TRIGGER_IN Circuit.....	5
3.2.2	12pins Circular Connector No.6, 7, 8, 9, and 10 pin: SIGNAL_OUT Circuit.....	5
3.3.	External Connector Pin Assignment.....	6
3.3.1	12pins Circular Connector HR10-10R-12PA (73) (Hirose) or Equivalent	6
3.3.2	75Ω BNC Connector	6
3.4.	LED Indicator	7
3.5.	Spectral Response	7
4.	Camera Functions	8
4.1.	Control System	8
4.2.	How to Save and Initialize Settings	8
4.3.	Link Speed and Link Count	8
4.4.	Pixel Format.....	9
4.5.	Flip.....	9
4.6.	Partial Scan (ROI)	9
4.7.	Frame Rate.....	10
4.8.	Internal Sync. Mode (Free Run Mode).....	10
4.9.	External Trigger Sync. Mode.....	11
4.10.	Trigger Sync. Mode and Delay Time to Start Exposure	12
4.11.	Restrictions on Timing for Trigger Pulse Input	13
4.12.	Fixed Trigger Shutter Mode H Sync. Trigger (LineSync)	14
4.13.	FAST Fixed Trigger Shutter Mode CLK Sync. Trigger (ClockSync)	15
4.14.	Pulse Width Trigger Shutter Mode H Sync. Trigger (LineSync).....	16
4.15.	FAST Pulse Width Trigger Shutter Mode CLK Sync. Trigger (ClockSync).....	17
4.16.	Exposure Time.....	18
4.17.	Calculation Formula for Manual Shutter Values with H Sync. (LineSync) Mode.....	18
4.18.	Manual Shutter Settings with CLK Sync. Mode.....	18
4.19.	Gain	18
4.20.	Gamma Correction.....	19
4.21.	Black Level Adjustment.....	19
4.22.	Image Quality Selection Mode.....	19
4.23.	Fan Control / Temperature Control.....	20
4.24.	Shading Correction	20
4.25.	Noise Filter	21
4.26.	Defective Pixel Correction	21
4.27.	Test Pattern Indication	24
4.28.	Cursor Indication.....	24
4.29.	LED Operational Mode.....	24

4.30.	Camera I/O.....	25
4.31.	User ID Save.....	25
4.32.	External Lighting Control.....	26
5.	Factory Settings.....	28
6.	Dimensions.....	29
6.1.	Camera Dimensions	29
6.2.	Optical Axis Accuracy	30
7.	Case for Indemnity (Limited Warranty).....	31
7.1.	Product Warranty	31
7.2.	CMOS Defective Pixels	31
7.3.	Product Support.....	31
8.	Appendix : Points to Note on Image Quality Characteristics	32

Aegis Electronic Group
www.aegiselect.com

1. Precautions

1.1. Handling Precautions

- Do not use or store camera in dusty or humid places.
- Do not apply excessive force or static electricity that could damage camera. Handle camera with care.
- Do not shoot direct images that are extremely bright (e.g., light source, sun, etc.). When extremely strong light source is shot, smear or blooming may occur. When camera is not in use, please put the lens cap on.
- Follow the instructions in [Chapter 3.3. "External Connector Pin Assignment"](#) for connecting camera. Improper connection may cause damages not only to the camera but also to the connected devices.
- Confirm mutual ground potential carefully and connect camera to monitors or computers. AC leak from the connected devices may cause damages or destroy the camera.
- Do not apply excessive voltage. (Use only the specified voltage.) Unstable or improper power supply voltage may cause damages or malfunction of the camera.

Our warranty does not apply to damages or defects caused by irregular and/or abnormal use of the product.

1.2. Restrictions on Applications

- The camera must not be used for any nuclear equipment or aerospace equipment with which mechanical failure or malfunction could result in serious bodily injury or loss of human life.
- The camera must not be used under conditions or environments other than those specified in this manual.
- Usage of VCC-SXCXP1SW for military related purposes is prohibited by List Controls for Export Trade Control Order.

1.3. Disclaimers (Exception Clause)

CIS should not be liable for any damages or losses if;

- damages or losses are caused by earthquake, lightning strike, fire, flood, or other acts of God.
- damages or losses are caused by deliberate or accidental misuse by user, or failure to observe information and instructions explained in this manual.
- damages or losses are caused by repair or modification conducted by user or any unauthorized party.

1.4. Image Quality Limitations

VCC-SXCXP1SW is a SWIR camera. Usage of SWIR sensor makes image quality characteristics of this model different from those using normal silicon image sensors.

Please refer to "Appendix: VCC-SXCXP1SW Points to note on image quality characteristics" for details.

2. Product Outline

VCC-SXCXP1SW is a SWIR (Short Wave Infrared) camera with CoaXPress interface. Using 1.3M pixels resolution, 1/2" global shutter type SWIR sensor, this model is capable of inspecting invisible part of objects with detecting wavelength spectrum from 400nm to 1700nm. Must have function ready for FA applications, such as external trigger, ROI (vertical), gamma correction, shading correction, and defective pixel correction. Suitable and useful for various inspection applications.

2.1. Features

- 65mm(H) × 65mm(W) × 65mm(D) cubic in size
- Global shutter type visible + SWIR image sensor
- Complies with CoaXPress Ver1.1.1. Supports CXP-3
- Supports PoCXP
- Exposure, Gain settings
- External trigger mode (Fixed trigger shutter mode / Pulse width trigger shutter mode)
- Complies with GenICam
- C lens mount

2.2. Accessories

- Standard Accessory
 - Lens cap

Aegis Electronic Group
www.aegiselect.com

3. Specifications

3.1. General Specifications

Electrical Specifications			
Image sensor	Sensor type	1/2" Global shutter type Visible + SWIR	
	Effective pixels	1296 (H) × 1032 (V)	
	Unit cell size	5μm(H) × 5μm(V)	
Interface		Complies with CoaXPress Ver,1.1.1, CXP-3 x 1	
Video output frequency	Pixel clock frequency	74.25MHz	
Video output format		Mono8 / Mono10 / Mono12	
Frame rate	CXP-3 8bit / 10bit / 12bit	134.73fps / 125.26fps / 71.52fps (with LineSync)	
Sync. system		Internal sync. system	
Resolution (The maximum pixel size)		1296(H) × 1032(V)	
Video signals	White clip level	255	With Mono8, Gainx1, ClkSync
	Set up level	0~1dig	With Mono8, Gainx1, ClkSync
	Dark shading	6dig or less for both horizontal and vertical.	With Mono8, Gainx1, ClkSync
Gain variable range		x1~x128 (0dB~+42dB) ※With 8bit mode, camera internally adds x4.00 offset gain.	
Shutter speed		Manual	
Trigger mode		Free run mode (Camera internal trigger) Trigger mode (Host, External terminal) • Fixed trigger shutter • Pulse width trigger shutter	
Power requirements		PoCXP: 18.5~26V	
Power consumption (Max)		3.6W [with free run]	
Mechanical Specifications			
Dimensions		H: 65mm W: 65mm D: 65mm excluding projection.	
Weight		Approx. 300g	
Lens mount		C mount	

Environmental Specifications			
Safety/Quality standards		UL: Complies with UL standard including materials. CE: EMC 2014/30/EU EN61000-6-4:2007+A1:2011 for Emission EN61000-6-2:2005 for Immunity RoHS: 2011/65/EU, 2015/863/EU EN50581(RoHS2)	
Durability	Vibration	Acceleration	: 98m/s ² (10G)
		Frequency	: 20 ~ 200Hz
		Direction	: X, Y, and Z 3 directions
		Testing time	: 120min each
	Shock	No malfunction with 980m/s ² (100G) for ±X, ±Y, and ±Z, 6 directions without packaging.	
Operational temperature		0°C ~ +45°C Humidity 20 ~ 80%RH with no condensation.	
Recommended temperature		0°C ~ +30°C Humidity 20 ~ 80%RH with no condensation.	
Storage temperature		-25°C ~ +60°C Humidity 20 ~ 80%RH with no condensation.	

Aegis Electronic Group
www.aegiselect.com

3.2. Input and Output Specifications

3.2.1 12pins Circular Connector No.11 pin: TRIGGER_IN Circuit

- 5.0V, 3.3V CMOS level / TTL level

Input voltage V_{t-} : 0.84Vdc (Min.), V_{t+} : 2.1Vdc (Max.)

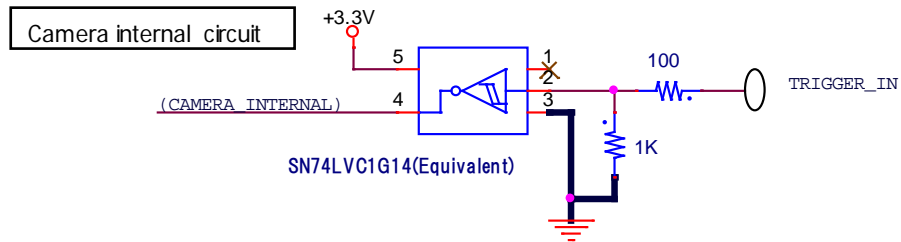

3.2.2 12pins Circular Connector No.6, 7, 8, 9, and 10 pin: SIGNAL_OUT Circuit

- 5.0V CMOS logic level output

Output voltage Low: 0.35Vdc (Max), High: 4.5Vdc (Min)

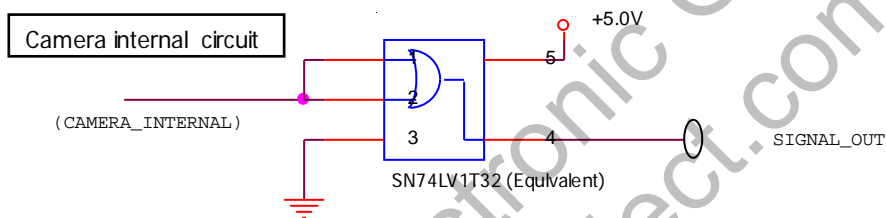

3.3. External Connector Pin Assignment

3.3.1 12pins Circular Connector HR10-10R-12PA (73) (Hirose) or Equivalent

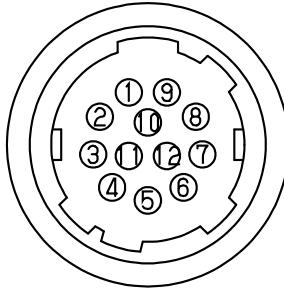

HR10-10R-12PA (Hirose) or equivalent

Pin No.	Signals	Description
1	GND	Ground camera chassis
2	NC	
3	GND	Ground camera chassis
4	NC	
5	NC	
6	Line1	General output
7	Line2	General output
8	Line3	General output
9	Line4	General output
10	Line5	General output
11	Line0	Trigger input
12	GND	Ground camera chassis

※NC=Non-Connection. Do not connect anything to the terminal.

3.3.2 75Ω BNC Connector

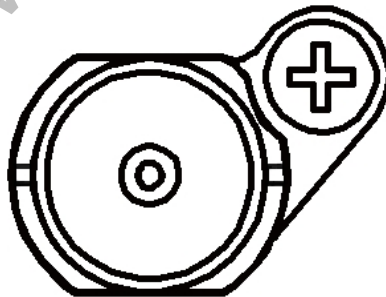

BCJ-BPLHA (CANARE)

3.4. LED Indicator

- With LED indicator Active, lighting patterns show the camera status by its way of lighting.

LED STATUS	Description
OFF	No power supply.
Green/Orange Fast Blinking [12.5Hz]	Disconnection of cables.
Green Lighting	Completion of connection between device and host.
Green Fast Blinking [12.5Hz] ※	Transmitting video data.
Orange Slow Blinking [1Hz]	Waiting for a trigger input.
Red Fast Blinking [12.5Hz] ※	System error.

※When Trigger Mode is off, LED blinks with 12.5Hz. When Trigger Mode is On, LED blinks with trigger cycle.
(With high speed trigger, blinking may look like lighting.)

3.5. Spectral Response

※Excludes characteristics of lens and light source.

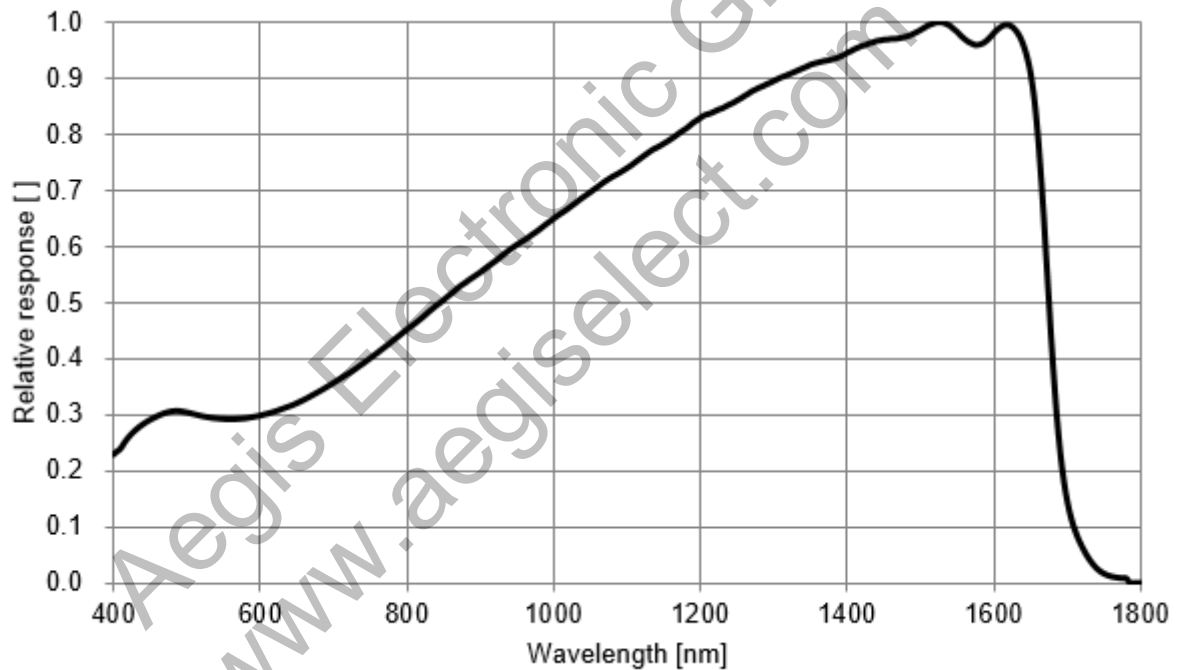

4. Camera Functions

4.1. Control System

Complies with CoaXPress ver. 1.1.1 standard.

4.2. How to Save and Initialize Settings

UserSets	
UserSetSelector	Default UserSet0
UserSetLoad	(Execute)
UserSetSave	(Execute)

- Select UserSet0 (User save area) with UserSetSelector and execute "UserSetSave" to save settings into camera non-volatile memory.
 - ※User cannot save settings as default settings.
 - ※Values of UserSetSelector is not subject to UserSetSave. Please set values before executing UserSetLoad / UserSetSave.
- UserSetLoad loads default settings (factory setting) or UserSet0 (User save area) selected by UserSetSelector.
 - ※Do not execute UserSetLoad while grabbing (acquiring) images.
- User ID and defective pixel correction data are not subject to UserSetLoad for default setting.
- Camera keeps Pixel Format and Image Quality Mode settings in operation even when executing UserSetLoad. If you wish to change Pixel Format and Image Quality Mode, please set them via serial commands.

UserSetSelector	{	Default	UserSetLoad >Excute	= Initialize(Factory setting)
		UserSet0	UserSetLoad >Excute	= Initialize(User setting)
			UserSetSave >Excute	= User setting Save

4.3. Link Speed and Link Count

Transfer Control	
ConnectionConfig	CXP3_X1

- CXP-3 : Link speed = 3.125Gbps, Link count = 1 (fixed)

4.4. Pixel Format

ImageFormatControl	
PixelFormat	Mono8 Mono10 Mono12

- Mono8 : Monochrome 8bit
- Mono10 : Monochrome 10bit
- Mono12 : Monochrome 12bit

※ Please do not change PixelFormat while grabbing (acquiring) images.

4.5. Flip

ImageFormatControl	
ReverseX	True / False

- ReverseX : Flip the image with X direction.

※ Please do not change Flip while grabbing (acquiring) images.

4.6. Partial Scan (ROI)

This is to increase frame rate by cutting and reducing line number to read out.

Supports only single ROI. Fixed number for horizontal dot.

ImageFormatControl	
RegionSelector	EffectiveRegion / Region1
RegionMode	On ※ Fixed
RegionDestination	Stream0 ※ Fixed
Width	1296 ※ Fixed
Height	8~1032 (per 8 pixels)
OffsetX	0 ※ Fixed
OffsetY	0~1024 (per 8 lines)

- RegionSelector : Select Region 1 for ROI operation.
Make sure to set RegionSelector to EffectiveRegion to start capturing images.
- RegionMode : ROI mode. Fixed with ON.
- RegionDestination : Selection of Stream to output. Fixed with Stream0.
- Width : Width of Region. Fixed with 1296.
- Height : Height of Region.
- OffsetX : Offset for X direction of Region. Fixed with 0.
- OffsetY : Offset for Y direction of Region.
※ Total number of OffsetY and Height must be less than 1032.

※ 1 frame after switched full frame scan mode and partial scan mode, or changed partial settings becomes invalid. Especially with fixed trigger shutter mode and pulse width trigger shutter mode, input dummy trigger 8 times, and use 9th and later trigger signals as legitimate imaging signals.

4.7. Frame Rate

The following formula calculate frame rate according to "Pixel format", "ROI (height)", and "Exposure time with ClockSync".

- ① For internal sync mode (free run mode), H sync (LineSync) mode

$$\text{Frame rate} = 1,000,000 / \{T_{\text{line}}[\mu\text{s}] \times (\text{Height} + 36)\} \text{ [fps]}$$

- ② For internal sync mode (free run mode), CLK sync (ClockSync) mode

$$\text{Frame rate} = 1,000,000 / \{T_{\text{line}}[\mu\text{s}] \times (\text{Height} + 46) + \text{Exposure time}[\mu\text{s}] - 7.372[\mu\text{s}]\} \text{ [fps]}$$

Refer to the table below for Tline (=Time for 1H) [μs].

PixelFormat	Width=1296
Mono8	6.94949
Mono10	7.47475
Mono12	13.09091

4.8. Internal Sync. Mode (Free Run Mode)

- This is a mode to use internal triggers continuously generated.
- Turn off TriggerMode and set TriggerSelector to AcquisitionStart.
- With ClockSync setting, function automatically sets Exposure Time and Effective Line not to overlap.

[Note] Do not change sync mode setting while grabbing (acquiring) images.

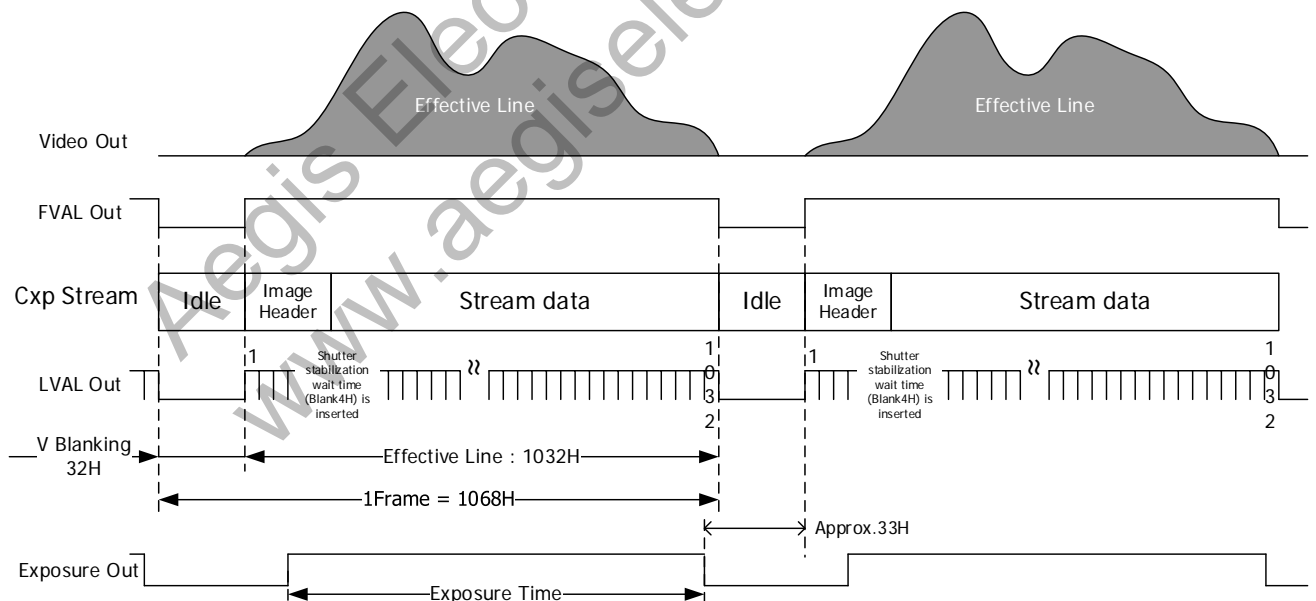

Vertical sync. timing (with free run): TriggerMode = Off, TriggerSyncMode = LineSync

4.9. External Trigger Sync. Mode

- This is a mode to capture images with preferred timings by inputting external trigger signals.
- Set TriggerSelector to AcquisitionStart and set TriggerSource to any one of Software/LinkTrigger0/Line0. Turn On TriggerMode.

Acquisition Control	
TriggerSelector	AcquisitionStart FrameStart
TriggerMode	On/Off
SensorSyncMode	LineSync ClockSync
TriggerActivation	RisingEdge FallingEdge LevelHigh LevelLow
TriggerSource	Software LinkTrigger0 Line0
TriggerSoftware	(Execute)

- TriggerSelector : (Equivalent to TriggerMode below.)
Select how to start capturing video.
 - AcquisitionStart : Free run mode [Internal sync. mode]
 - FrameStart : External trigger mode
- TriggerMode :
 - On : Enable trigger selected with TriggerSource. (TriggerSelector = FrameStart)
 - Off : Disable trigger selected with TriggerSource. (TriggerSelector = AcquisitionStart)

LineSync/ClockSync is selectable even when TriggerMode is off.
With ClockSync setting, function automatically sets frame cycle not to overlap.

※Do not change TriggerMode while grabbing (acquiring) images.
- SensorSyncMode :
 - LineSync : H sync. mode (Controls exposure time per line)
Free run / Fixed-trigger shutter / Pulse width trigger shutter
Valid overlapping operation. (Exposure while reading out images)
 - ClockSync : CLK sync. mode (Controls exposure time per sensor clock)
Free run / FAST fixed / FAST pulse width trigger shutter
Invalid overlapping operation. (Exposure while reading out images)

※Do not change SensorSyncMode while grabbing (acquiring) images.
※Change Sensor Sync Mode when there is no trigger input.

□ TriggerActivation:

This is to select type and polarity of external trigger signals out of the followings.

- RisingEdge : Fixed trigger shutter mode : Exposure starts with rising edge.
- FallingEdge : Fixed trigger shutter mode : Exposure starts with falling edge.
- LevelHigh : Pulse width trigger shutter mode : Exposure for High-Level period.
- LevelLow : Pulse width trigger shutter mode : Exposure for Low-Level period.

※Do not change TriggerActivation while grabbing (acquiring) images.

※When set LinkTrigger0, disturbance images may occur when start grabbing for the first time after setting FallingEdge and LevelLow.

□ TriggerSource :

This is to select where to send external triggers.

- Software : Trigger input by TriggerSoftware command.
(Software Trigger is invalid with Rising Edge mode.)
- LinkTrigger0 : External trigger input from CoaXPress Host Device.
Please refer to specification manuals for Host Device to know how to generate triggers.
- Line0 : External trigger input from 12pins circular connector.

※Do not change TriggerSource while grabbing (acquiring) images.

□ TriggerSoftware : Software trigger

Camera generates a trigger to capture one frame image by executing this command.

Make sure to set TriggerSource to Software to execute.

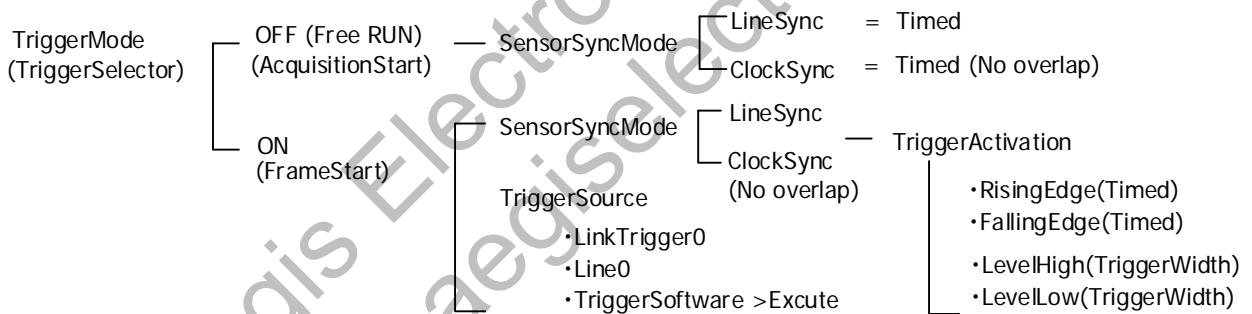

4.10. Trigger Sync. Mode and Delay Time to Start Exposure

- ♦ H sync. Trigger mode (LineSync) : 1H of jitter occurs from inputting trigger to exposure.
(Valid overlapping operation).
- ♦ CLK sync. Trigger mode (ClockSync) : Capable of precise trigger operation with less delay time from trigger input. (Invalid overlapping operation).

Trigger sync. mode and delay time to start exposure

	CXP3_X1
Delay time to start exposure with H sync. trigger (LineSync)	Approx. 1H ~ 2H
Delay time to start exposure with CLK sync. trigger (ClockSync)	Approx. 0.13μs

4.11. Restrictions on Timing for Trigger Pulse Input

- With LineSync mode, user can input a trigger for the next frame while camera is reading out signals. However, do not input a trigger pulse to end exposure while camera is reading out signals. In other words, a trigger pulse to start reading out signals for the next frame before completion of reading out signals for the prior frame is restricted.

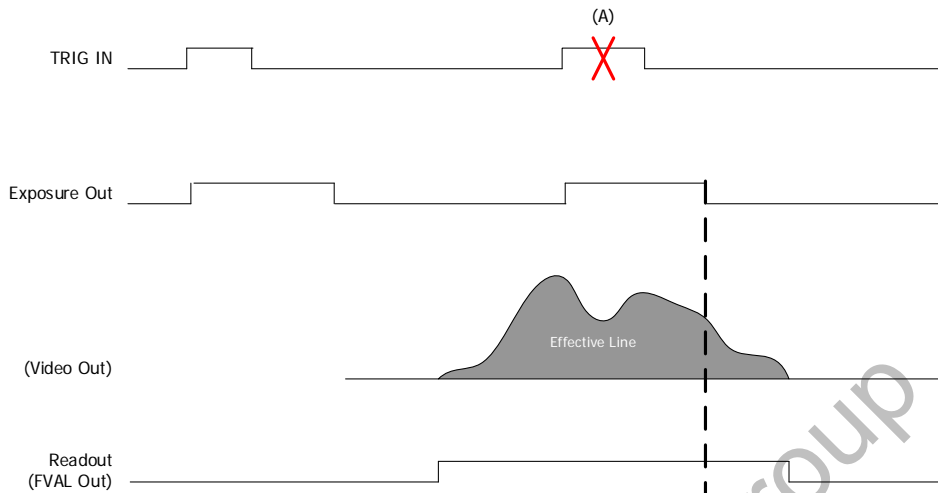

- If there is a trigger input with restricted timing as explained in the above, "IllegalTriggerFlag" becomes "1".

Acquisition Control	
IllegalTriggerFlag	0 or 1

Device Control	
ErrorFlagReset	(Execute)

This is to reset IllegalTriggerFlag to "0".

4.12. Fixed Trigger Shutter Mode H Sync. Trigger (LineSync)

(TriggerMode=On, SensorSyncMode=LineSync, TriggerActivation= RisingEdge)

- This is a mode to start exposure with external trigger input and expose for a period set by Exposure Time.
- Trigger operation is H sync. V-sync. reset.
- Delay time (Exposure Time Delay) from detecting the trigger edge in camera to actually starting exposure is 1H~2H.
- Since external trigger signals synchronize with camera internal H signals, 1H jitter occurs to Exposure Time Delay.
- Input a trigger pulse with more than 1H width. For time of 1H, please refer to [Section 4.7](#) for details.
- There is an exposure time period for approx. 7.372μs at the trailing edge of Exposure output.



- Camera accepts triggers while outputting video images. However, do not input any trigger signals to start outputting the next video before completion of prior video output.
- Camera ignores trigger input during exposure time. (Refer to (A) in the drawing below). Do not use any trigger cycle shorter than 1 frame.

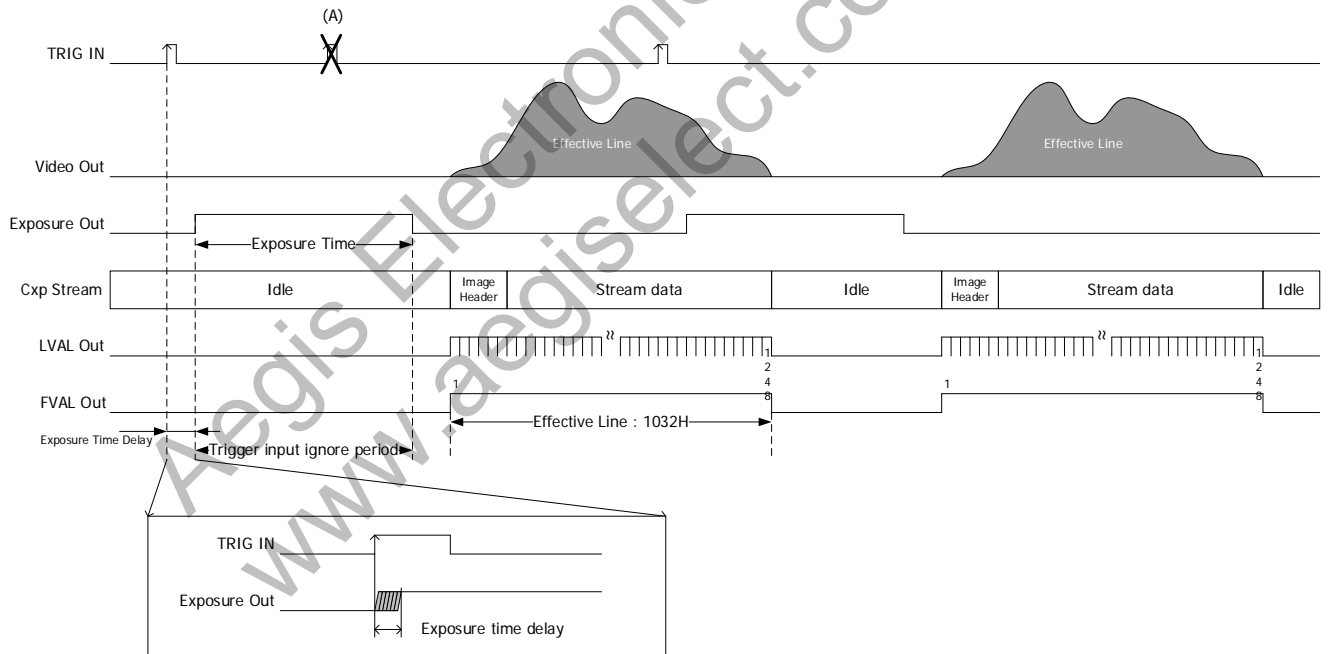

4.13. FAST Fixed Trigger Shutter Mode CLK Sync. Trigger (ClockSync)

(TriggerMode=On, SensorSyncMode=ClockSync, TriggerActivation=RisingEdge)

- This is a mode to start exposure with external trigger input and expose for a period set by Exposure Time.
- Trigger operation is CLK sync. V-sync. reset. Delay time (Exposure Time Delay) from detecting the trigger edge in camera to actually starting exposure is approx. $0.13\mu s$. Input a pulse with more than $1\mu s$ width as a trigger.
- There is an exposure time period for approx. $7.372\mu s$ at the trailing edge of Exposure output.

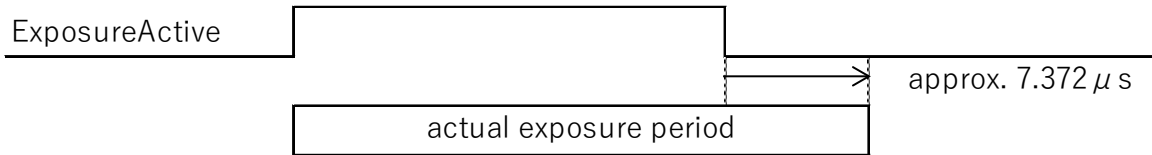

- Camera does not accept any triggers while outputting video images. Camera ignores trigger input during exposure time and while reading out signals. (Refer to (A) and (B) in the drawing below)

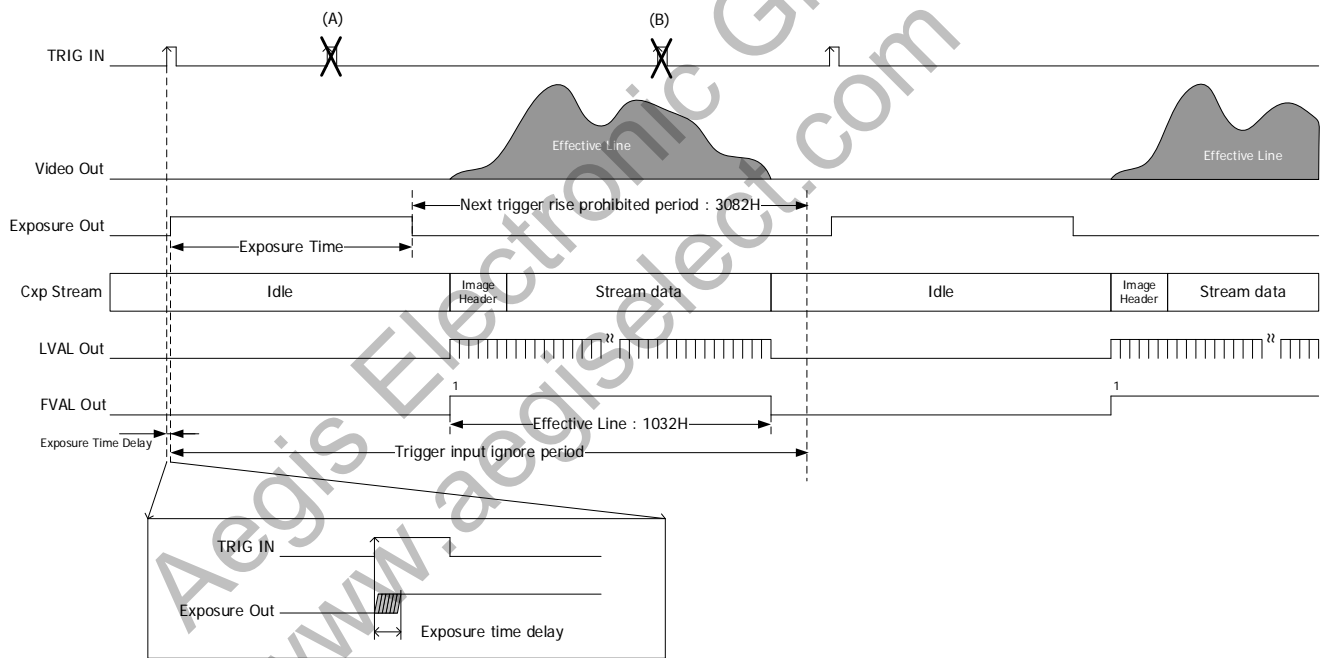

4.14. Pulse Width Trigger Shutter Mode H Sync. Trigger (LineSync)
 (TriggerMode=On, SensorSyncMode=LineSync, TriggerActivation=LevelHigh)

- This is a mode to start exposure with external trigger input and expose for a period of pulse width.
- Trigger operation is H sync. V-sync. reset.

Delay time (Exposure Time Delay ①) from detecting the trigger edge in camera to actually starting exposure is

1H~2H. Delay time (Exposure Time Delay ②) from detecting the end edge in camera to actually end exposure is

1H~2H+7.372μs.

- Since external trigger signals synchronize with camera internal H cycle, approx. 1H jitter occurs to Exposure Time Delay ① and ②. With pulse width trigger mode, jitters may occur for both exposure start edge and exposure end edge. Exposure time changes and flicker may become noticeable, especially with high-speed shutter setting. Fixed trigger shutter mode might eliminate those flickers. However, synchronizing trigger pulse with camera H cycle (LVAL) to input will solve this problem.
- Functionally, there is no upper limitation, but noises such as dark noise shadings may become noticeable with long time exposure. Please note that increase of white defective pixels is inevitable with this image sensor.
- There is an exposure time period for approx. 7.372μs at the trailing edge of Exposure output.



- Camera ignores trigger input during exposure time. Do not use any trigger cycle shorter than 1 frame.
- Camera accepts triggers while outputting video images. However, do not input any trigger signals to start outputting the next video before completion of prior video output. (Refer to (A) in the drawing below)

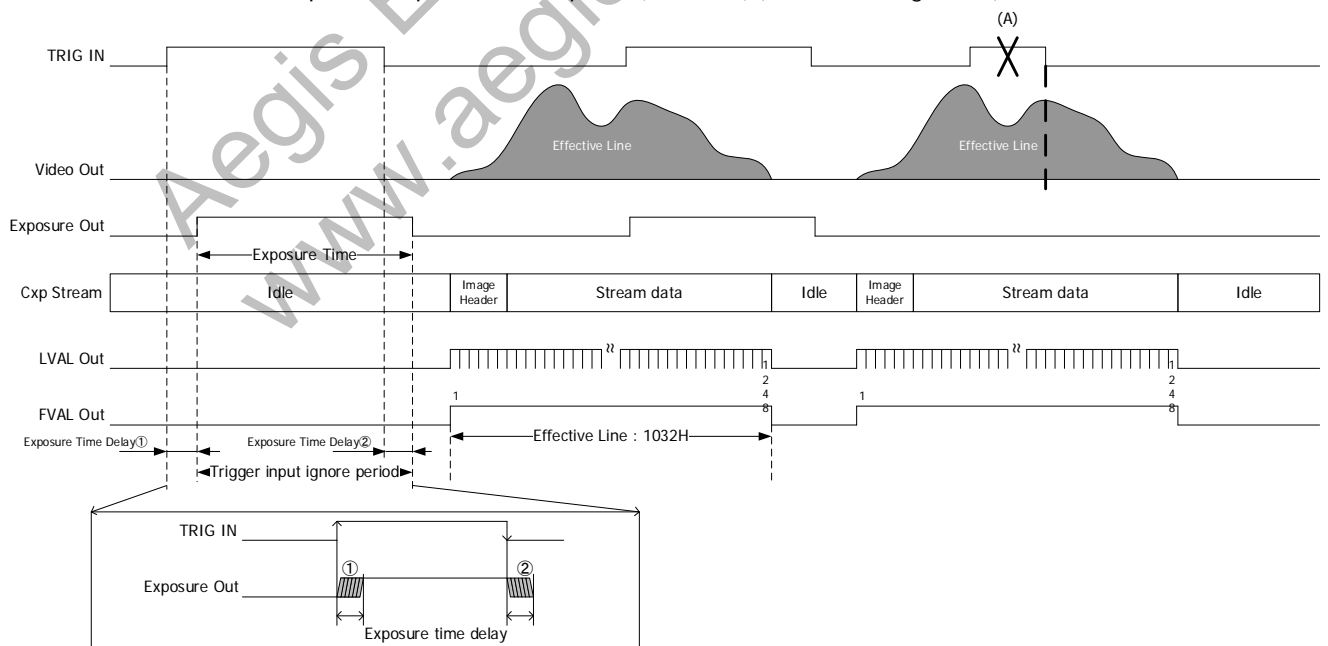

4.15. FAST Pulse Width Trigger Shutter Mode CLK Sync. Trigger (ClockSync)

(TriggerMode=On, SensorSyncMode=ClockSync, TriggerActivation=LevelHigh)

- This is a mode to start exposure with external trigger input and expose for a period of pulse width.
- Trigger operation is CLK sync. V-sync. reset.

Delay time (Exposure Time Delay ①) from detecting the trigger edge in camera to actually starting exposure is

Approx. 0.13 μ s. Delay time (Exposure Time Delay ②) from detecting the end edge in camera to actually end exposure is approx. 7.372 μ s.

- Pulse width 2.628 μ s (Min.) ~ approx. 2 frames
Functionally, there is no upper limitation, but noises such as dark noise shadings may become noticeable with long time exposure. Please note that increase of white defective pixels is inevitable with this image sensor.
- There is an exposure time period for approx. 7.372 μ s at the trailing edge of Exposure output.

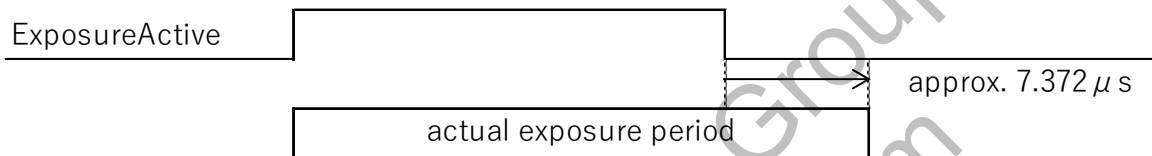

- Camera ignores trigger input during exposure time. Refer to (A) in the drawing below.

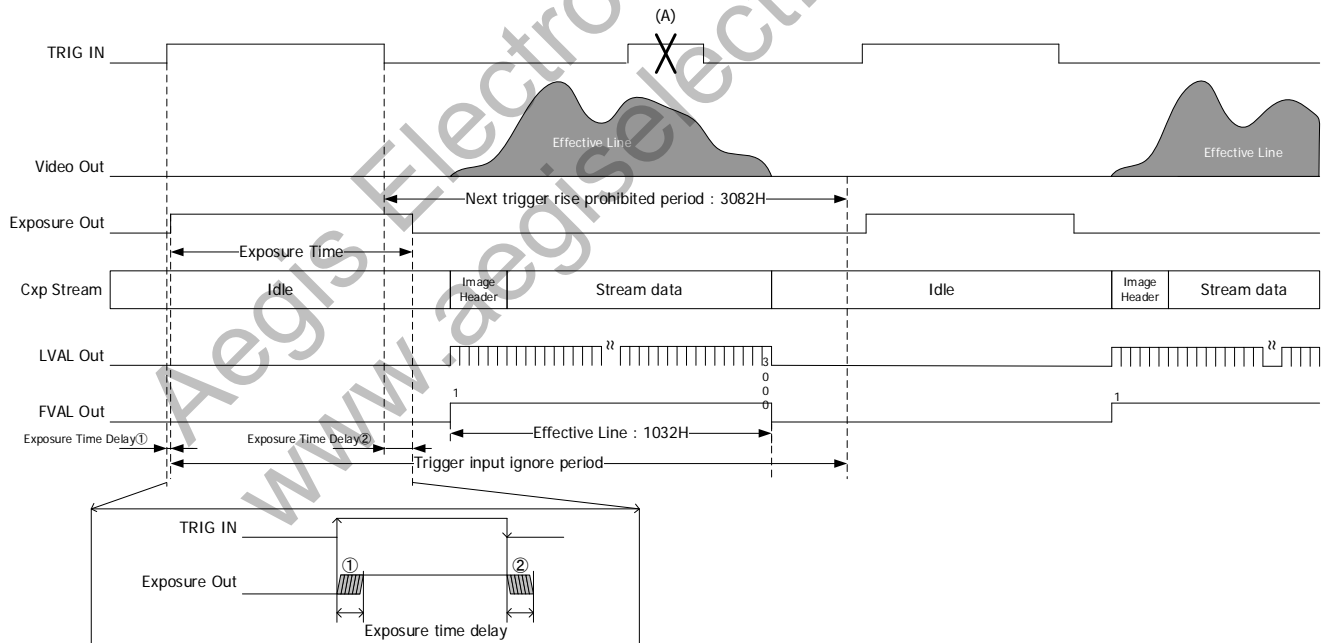

4.16. Exposure Time

Acquisition Control	
ExposureMode	Timed TriggerWidth
ExposureTime (μs)	Equivalent time for 1H~1032H: LineSync 10μs~200,000μs: ClockSync
ExposureTimeMax	(ReadOnly)

- ExposureMode : This is to check if current mode is Timed or Trigger Width.
- ExposureTime : Exposure time (Valid when ExposureMode is Timed)
 - With H sync. Trigger mode, set exposure time per 1H. Minimum value is 1H. Command returns rounded values per 1H according to mode.
 - With CLK sync. Trigger mode, set exposure time per 1μs.
 - ※With Light control mode ON, this register becomes invalid.
- ExposureTimeMax : Maximum exposure time
 - With internal sync mode and fixed trigger shutter mode, set a smaller value than ExposureTimeMax.
 - ※With H sync trigger mode (LineSync), maximum value clips according to the effective line number.
 - ※With CLK sync trigger mode (ClockSync), maximum value will not clip according to the effective line number.

4.17. Calculation Formula for Manual Shutter Values with H Sync. (LineSync) Mode

Formula : Exposure time = Time for 1 line x Exposure line count + **7.372μs**

※Refer to [Section 4.7](#) for Time for 1 line.

※Minimum value is 1 line. Maximum value clips according to the effective line number.

4.18. Manual Shutter Settings with CLK Sync. Mode

- Minimum setting value : 10μs (Approximate value)
- Maximum setting value : 200ms (Approximate value)
 - ※With CLK sync mode, there is no clipping with effective line number.
- Set shutter value per 1μs (Approximate value)
 - ※Because 74.25MHz clock generates manual shutter values, a slight difference occurs between the set value and the actual value.

4.19. Gain

AnalogControl	
Gain	1.00~128.00

Gain setting range is x1.00 to x128.0. User can set higher gain value more than x16.00. However, with high gain settings, noises will increase and image quality deteriorates.

※With 8-bit mode, camera internally adds x4.00 offset gain. Therefore, with more than x4.00 gain setting, deterioration of image quality is inevitable.

4.20. Gamma Correction

- This is to execute gamma correction.

AnalogControl	
Gamma	0.10~9.90

Gamma : Set gamma correction values per 0.01step.

※Camera updates gamma table at the timing of image output.

With continuous operation mode, camera rewrites gamma table first (approx. 20ms: refer to Command ACK as a rough guide), and applies the updated gamma table at the timing of image output.

If user changes gamma coefficient while waiting for a trigger input, camera rewrites gamma table, and outputs images with the updated gamma table with a trigger.

4.21. Black Level Adjustment

- This is to adjust black level of image sensor.

AnalogControl	
BlackOffset	-64~63

- Setting values are 12bit converted values. With 10bit mode, values will be equivalent to ± 16 .
With 8bit mode, values will be equivalent to ± 4 .

※Make sure to stop grabbing (acquiring images) to change settings

4.22. Image Quality Selection Mode

- This is to select image quality mode.

AnalogControl	
ImageQualityMode	StandardMode LowNoiseMode

- Image Quality Mode
- StandardMode : Standard mode
 - LowNoiseMode : Valid only with Mono8.
With this mode, frame rate and sensitivity will deteriorate (equivalent to Mono10) but S/N improves.

4.23. Fan Control / Temperature Control

- This is to monitor and control camera temperature.

DeviceControl	
DeviceTemperatureSelector	Sensor MainBoard
Temperature	(readonly)
FanSpeed	Off Low High

- DeviceTemperatureSelector : Selection of temperature measurement point.
 - Sensor : Temperature of CMOS sensor.
 - MainBoard : Temperature of FPGA.
- Temperature : Temperature with Celsius (°C).
- FanSpeed : Selection of internal fan operation.
 - Off : Stop
 - Low : Low-speed operation
 - High : High-speed operation

[Note] Do not close opening of vent holes prepared on the right and left sides of camera chassis.

4.24. Shading Correction

- This is to correct the drop in the amount of peripheral light caused by lens and others.

AnalogControl	
ShadingCorrectionDataSelector	Off/Table1/Table2/Table3
DetectShading	(Execute)

- ShadingCorrectionDataSelector : This is to turn off shading correction function or to select a correction table.
- Off : Disable shading correction.
 - Table1~3 : Enable shading correction with selected correction Table.
- DetectShading : Select a Table 1-3 and execute function to acquire shading correction data to the selected Table. Execute UserSetSave to save the acquired correction data.

※Set ROI to full size (1296 x 1032) to execute.

※Acquire correction data only when camera is in operation.

Acquisition of shading correction data is invalid when there is no output from the camera.

※Correction data is not subject to UserSetLoad.

※When obtain correction data with trigger shutter mode, the data sometimes becomes unstable. In this case, change the trigger cycle in small measure and obtain correction data again.

Before shading correction

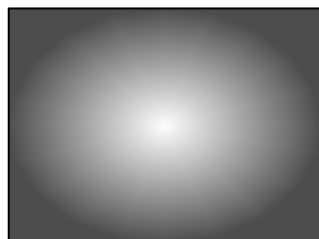

After shading correction



4.25. Noise Filter

This is to detect impulse noise by image processing to remove.

AnalogControl	
ImpulseNoiseFilter	On/Off
ImpulseNoiseFilterThreshold	0~4095

- ImpulseNoiseFilter : On/Off control for noise removal. Recommendation is ON.
- ImpulseNoiseFilterThreshold : Intensity of noise detection and removal function.
With smaller values, results will be better. However, too small values may cause negative effects.
Recommendation is approx. 256. With 4095, results will be equivalent to those for function off.
- With DefectPixelCorrection Off, ImpulseNoiseFilter function becomes invalid.

4.26. Defective Pixel Correction

This is to detect and correct defective pixels in output data from the sensor.

There are two types of defective pixel data.

- Defective data registered at factory
Data registered upon shipment from our factory. These data cannot be over-written.
- Defective data registered by user
Data registered by user. In addition to the correction of defective pixel data registered upon shipment, we provide a method to update the defective pixel data. With DefectPixelDefault command, user can delete user-registered data.

User can register up to 128 points. (Note: Up to 64 points per CH.)

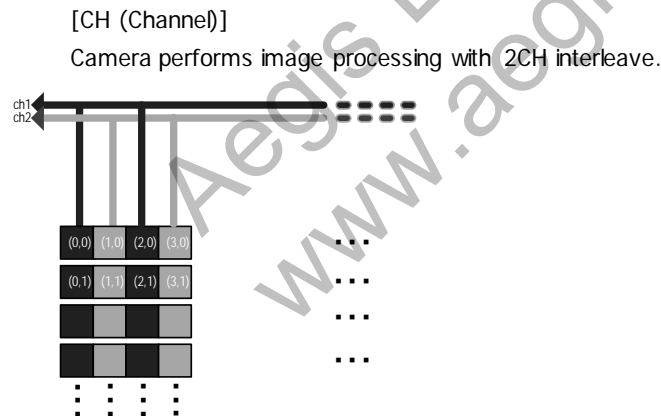

Defective pixel correction function calculates value for X pixel referring to peripheral pixels (up and down, left and right). When all peripheral pixels, X1, X2, X3, and X4, as shown in the left, are already registered as defective pixels, user cannot correct X pixel.

Enable or disable Defective Pixel Correction

This is to enable or disable defective pixel correction function.

Function controls both defective pixel correction data registered at factory and registered by user at one time.

AnalogControl	
DefectPixelCorrection	On/Off
DefectPixelAdd	(Execute)
DefectPixelAddOffsetX	0~1295
DefectPixelAddOffsetY	0~1031
DefectPixelDelete	(Execute)

Updating defective pixel data with coordinates

This is to update defective pixel data by designating coordinates to add or delete.

- DefectPixelCorrection : Enable or disable defective pixel correction function.
 - DefectPixelAddOffsetY : Designate Y coordinate.
 - DefectPixelAddOffsetX : Designate X coordinate.
 - Execute DefectPixelAdd to register the designated coordinates as defective pixels.
 - Execute DefectPixelDelete to delete the designated coordinates from registered defective pixels.
- ◇ When user designate the same coordinates as those registered at factory, function ignores them.
- ◇ DefectPixelDelete command deletes only the added pixels by user.

Updating defective pixel data with detection function

This is for user to detect and register correction data of white defect pixels.

AnalogControl	
DefectDetectionThresholdValue	0~4095
DefectDetection	(Execute)
DefectDetectionStatus	(ReadOnly)
DefectPixelDefault	(Execute)
DefectCorrectMode	Reacquire/Add

- DefectDetectionThresholdValue : This is to set a threshold value (0~4095: 12bit equivalent) for user defective pixel detection. Function registers data with luminance level that exceeds the threshold value designated here. With 8bit images, designate a value of 16 times of signal level as a threshold value.
- DefectDetection : This is to detect defective pixels. Function automatically registers pixels that exceed the level designated with DefectDetectionThresholdValue. Make sure to shield light from image sensor to execute. Function reflects defective pixel correction registered by user immediately after execution. Execute UserSetSave after DefectDetection to save data into non-volatile memory.
- DefectDetectionStatus : This is to indicate results of defective pixel detection proceeded by user.

0	No defective pixel correction data registered by user.
Value (128 or less)	Normal operation (Number of defective pixels detected and registered by user)
0x000e0001(917505)	Total number of defective pixel correction data exceeds the maximum number to register in one CH.
0x000e0002(917506)	Total number of defective pixel correction data exceeds the maximum number to register.

When result shows 129 and over, check if user threshold value (DefectDetectionThresholdValue) is appropriate as well as defective pixel indication.

※Error may appear in the decimal system depending on frame grabber board to use.

- DefectPixelDefault : This is to delete entire defective pixel correction data registered by user.
- DefectCorrectMode : This is to select detection mode of defective pixels out of the followings.
 - Reacquire mode: This mode deletes defective pixel data except those registered by designating coordinates first, and reacquire defective pixels.
 - Add mode: This mode acquires defective pixels in addition to the current pixels registered.

[Note]

- Make sure to acquire defective pixel correction data when camera is in operation.
- To acquire defective pixel correction data by changing threshold value of DefectDetectionThresholdValue, execute DefectPixelDefault first to delete defective pixel correction data registered by user and reacquire data.
- Maximum number of defective pixels to register and to correct may not always be the same due to following reasons.
 - (1) With white defects detection, if one of interleave channel reaches the maximum number of defective pixels to register, correction stops. Function registers data up to that point, outputs error, and ends operation.
 - (2) When there is no effective pixel around the pixel to add (on the left, right, top, and bottom), user can register but cannot correct that pixel.

□ Indication of defective pixel coordinates

This is to indicate the coordinates of registered defective pixels.

AnalogControl	
RegisteredDefectSelector	UserState/InitialState
DefectPixelNumber	1~128/1~896
DefectPixelOffsetY	(ReadOnly)
DefectPixelOffsetX	(ReadOnly)
DefectPixelType	(ReadOnly)

- RegisteredDefectSelector : Selection of defective pixel data to indicate if data is factory registered data or user registered data.
- DefectPixelNumber : This is to designate the number of the registered defective pixels.
Designate defective pixel data registered at factory and the table number of defective pixels registered by user.
- DefectPixelOffsetY : Y coordinate of the defective pixel designated with DefectPixelNumber. When there is no defective pixels in the designated table, function indicates 65535.
- DefectPixelOffsetX : X coordinate of the defective pixel designated with DefectPixelNumber. When there is no defective pixels in the designated table, function indicates 65535.
- DefectPixelType : Defective type of the pixel designated with DefectPixelNumber out of the followings.

- 1: White defects registered upon shipment from factory
- 2: Black defects registered upon shipment from factory
- 6: Defects registered by user
- 7: Defects additionally registered by user
- 65535: Table without defects

AnalogControl	
ChannelNumber	1~2
DefectPixelChannelCount	(ReadOnly)

- ChannelNumber : This is to designate channel number of defective pixel correction.
- DefectPixelChannelCount : Number of defective pixels for the channel designated with ChannelNumber.
This number is the total number of defective pixels count registered at factory and registered by user.

4.27. Test Pattern Indication

- This is to display test pattern from camera. This is useful to check if your system is operating properly.

ImageFormatControl	
TestPattern	Off GrayHorizontalRamp GrayHorizontalRampMoving

※Displaying test pattern and cursor are mutually exclusive.

4.28. Cursor Indication

- This is to show cursor on your display screen.

ImageFormatControl	
CursorPattern	Off/On
CursorOffsetX	X coordinate
CursorOffsetY	Y coordinate
CursorColor	White/Black

※Displaying cursor and test pattern are mutually exclusive.

- CursorPattern : Cursor indication On/Off.
- CursorOffsetX : X coordinate of vertical cursor.
- CursorOffsetY : Y coordinate of horizontal cursor.
- CursorColor : To select the color of cursor (black or white).

4.29. LED Operational Mode

- This is to change operational mode of LED at the rear of camera. For information on lighting patterns, refer to [Section 3.4. LED Indicator](#).

DeviceControl	
DeviceIndicatorMode	Active ErrorStatus Inactive

- Active : Indication of communication status of CoaXPress
- ErrorStatus : OFF with normal operation.
Lights only with video transmission error or inappropriate trigger input.
- Inactive : ALL LED OFF

4.30. Camera I/O

According to LineSource setting, camera outputs the following signals through pin No. 6, 7, 8, 9, and 10 of 12pins circular connector.

Digital IO Control	
LineSelector	Line0 Line1 Line2 Line3 Line4 Line5
LineMode	Input / Output (ReadOnly)
LineSource	Off ExposureActive FrameActive LineActive TriggerPacketActive Light0~4

LineSelector : This is to select a line to set.

Line0 : Pin No.11 of 12pins circular connector ※Line 0 is only for FrameTrigger input.

Line1 : Pin No.6 of 12pins circular connector

Line2 : Pin No.7 of 12pins circular connector

Line3 : Pin No.8 of 12pins circular connector

Line4 : Pin No.9 of 12pins circular connector

Line5 : Pin No.10 of 12pins circular connector

LineSource : This is to select signals to input to and output from the Line selected with LineSelector.

FrameTrigger Trigger input to camera. (Dedicated to Line 0)

ExposureActive This is to indicate exposure period of image sensor with Hi active.

FrameActive This is to indicate effective period of video output frame with Hi active.

LineActive This is to indicate effective period of video output line with Hi active.

TriggerPacketActive This is to decode and output packet signals of uplink trigger from frame grabber.

Light0~4 This is to output light emission trigger signals for external lighting equipment.

For details, please refer to [Section 4.32. External Lighting Control](#) in this manual, and "VCC-SXCXP1SW Lighting Control Application Note" in a separate document.

4.31. User ID Save

Set a letter string as DeviceUserID with up to 16 characters including terminal NUL letter (¥0). Set a letter string as DeviceUserString with up to 256 characters including terminal NUL letter (¥0). Execute UserSetSave to save these letter strings. These data are not subject to UserSetLoad.

DeviceControl	
DeviceUserID	Manual
DeviceUserString	Manual

※Some capture boards take up to 251 letters only.

4.32. External Lighting Control

Camera can output lighting emission trigger signals via camera I/O for up to five kinds of external lighting equipment. Define emission pulse width and exposure time in advance. User can acquire images with emitting light in sequence per input triggers (or free run).

For details, please refer to "VCC-SXCXP1SW Lighting Control Application Note" in a separate document.

Digital IO Control		
Light Control Mode	Off / On	
Light Controller Range	0 ~ 4	
Light Pulse Mode	Timed / Exposure	
Light Exposure Delay	1 ~ 50 [μ s]	
Light Control Selector	Light0 ~ Light4	
	Light Width	10[μ s] ~ 200,000 [us]
	Light Control Exposure Time	10[μ s] ~ 200,000[μ s]
	Light Control Frame Period	(Read Only)
Light Control Total Frame Period	(Read Only)	

- LightControlMode : On/Off of emission trigger sequence function.
On: Enable emission trigger sequence function and outputs emission triggers.
Off: Disable emission trigger sequence.
※Light Control Mode is valid only when SensorSyncMode = ClockSync.
- Light Controller Range: This is to set effective range of emission trigger (=Light).
0: Outputs Light0 per trigger.
1: Repeats outputting Light0⇒Light1⇒Light0⇒... in sequence per trigger.
2: Repeats outputting Light0⇒Light1⇒Light2⇒Light0⇒... in sequence per trigger.
3: Repeats outputting Light0⇒Light1⇒Light2⇒Light3⇒Light0⇒... in sequence per trigger.
4: Repeats outputting Light0⇒Light1⇒Light2⇒Light3⇒Light4⇒Light0⇒... in sequence per trigger.
※ When Trigger Mode is off, light outputs in sequence without trigger input.
- Light Pulse Mode: This is to choose how to designate pulse width of emission trigger.
Timed: Pulse width set with Light Width 0~4.
Exposure: The same pulse width as exposure time.
※ The way to designate exposure time changes depending on trigger mode settings.
- Light Exposure Delay: This is to designate delay time from emission trigger output to the actual exposure start of image sensor.
※ The designated exposure delay time is common value for all emission triggers.
- Light Control Selector: This is to choose emission trigger to set out of Light0~Light4.
Set Light Width and Light Control Exposure Time explained below for each emission trigger.
User can check Frame Period corresponds to each emission trigger.

- Light Width: User can set pulse width for each emission trigger per μs unit.
 ※ Valid only when Light Pulse Mode = Timed.
 Value for Light Width needs to be smaller than Light Control Frame Period.
- Light Control Exposure Time: This is to set exposure time corresponds to each emission trigger.
 ※ Valid only when TriggerMode is OFF, or when TriggerMode is ON and TriggerActivation is with RisingEdge or FallingEdge.
 ※ When LightControlMode is ON, normal Exposure Time (in Acquisition Control) becomes invalid.
- Light Control Frame Period:
 This is to read out frame time corresponds to each emission trigger per μs unit.
 $\text{Frame time} = (\text{Light Exposure Delay}) + (\text{Light Control Exposure Time}) + (\text{Readout time})$
 Take time interval longer than frame time between the current trigger and the next Frame Trigger input.
 ※ Time interval shown in the timing chart below is reference value with free run.
- Light Control Total Frame Period:
 This is to read out sum total of Frame Period for each emission trigger selected with Light Controller Range per $[\mu\text{s}]$ unit.
 When TriggerMode is OFF, Total Frame Period must be longer than minimum emission interval of strobe power supply.
 ※ Frame period shown in the timing chart below is reference value with free run.

[Reference timing chart]

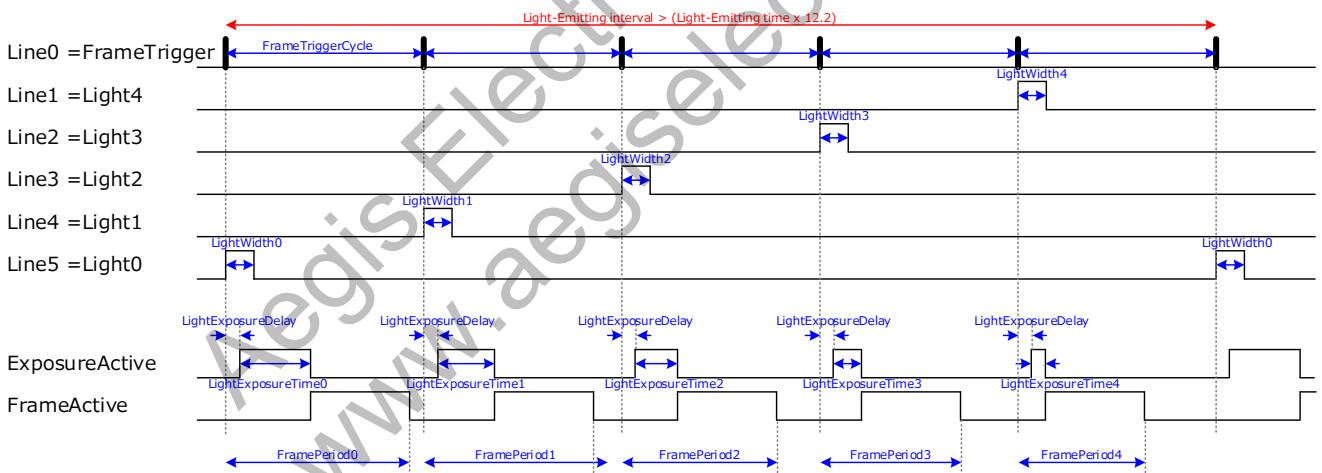

5. Factory Settings

Function	Data	Description
FanSpeed	Low	Low speed operation
TriggerSelector	AcquisitionStart	Equivalent to TriggerMode=Off
TriggerMode	Off	Links to TriggerSelector
SensorSyncMode	LineSync	Horizontal sync. mode
TriggerSource	LinkTrigger0	UP link trigger
TriggerActivation	RisingEdge	Rising edge
ExposureTime	7179.0	V active period+7.372μs
Gain	1.00	x1.00
Gamma	1.00	Gamma coefficient=1.00
ImpulseNoiseFilter	On	Impulse noise filter On
ImpulseNoiseFilterThreshold	255	Intensity of impulse noise detection and removal
DefectPixelCorrection	On	Defective pixel correction On
DefectPixelAddOffsetX	0	X coordinate of defective pixel
DefectPixelAddOffsetY	0	Y coordinate of defective pixel
DefectDetectionThresholdValue	1800	Threshold value of defective pixel detection
ShadingCorrectionDataSelector	Off	Shading correction table
BlackOffset	0	Black level initial value
ImageQualityMode	StandardMode	Normal mode
PixelFormat	Mono8	Mono 8bit
ConnectionConfig	CXP3_X1	CXP link configuration
TestMode	NormalOperation	For Link test mode "Normal Operation"
ReverseX	FALSE	Horizontal flip OFF
Width	1296	Horizontal image size (Fixed value)
Height	1032	Vertical image size (Maximum setting)
OffsetX	0	X direction offset = 0
OffsetY	0	Y direction offset = 0
TestPattern	Off	Test pattern indication Off
CursorPattern	Off	Cursor indication Off
CursorOffsetX	647	Position of cursor X
CursorOffsetY	515	Position of cursor Y
CursorColor	White	Cursor color
DeviceIndicatorMode	Active	CoaXPress communication status
LineSource	FrameTrigger	Circular 12P setting (Fixed to Line0), Line1~5 Off
LightControlMode	Off	Emission trigger sequence is invalid
DeviceUserID		User set letter string (16 letters)
DeviceUserString		User set letter string (256 letters)

※PixelFormat and ImageQualityMode are not subject to UserSetLoad operation.

6. Dimensions

6.1. Camera Dimensions

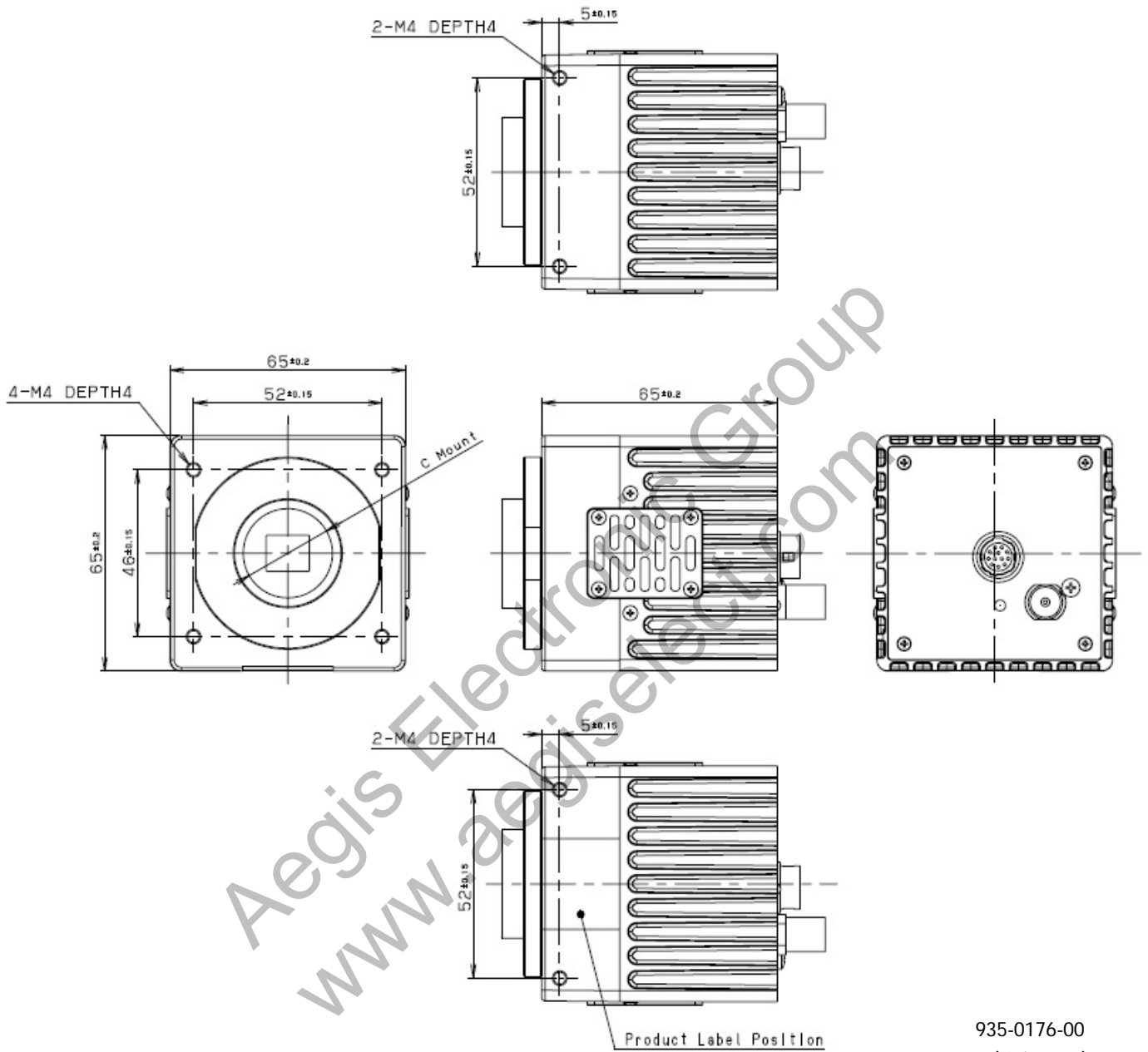

935-0176-00
(Unit: mm)

6.2. Optical Axis Accuracy

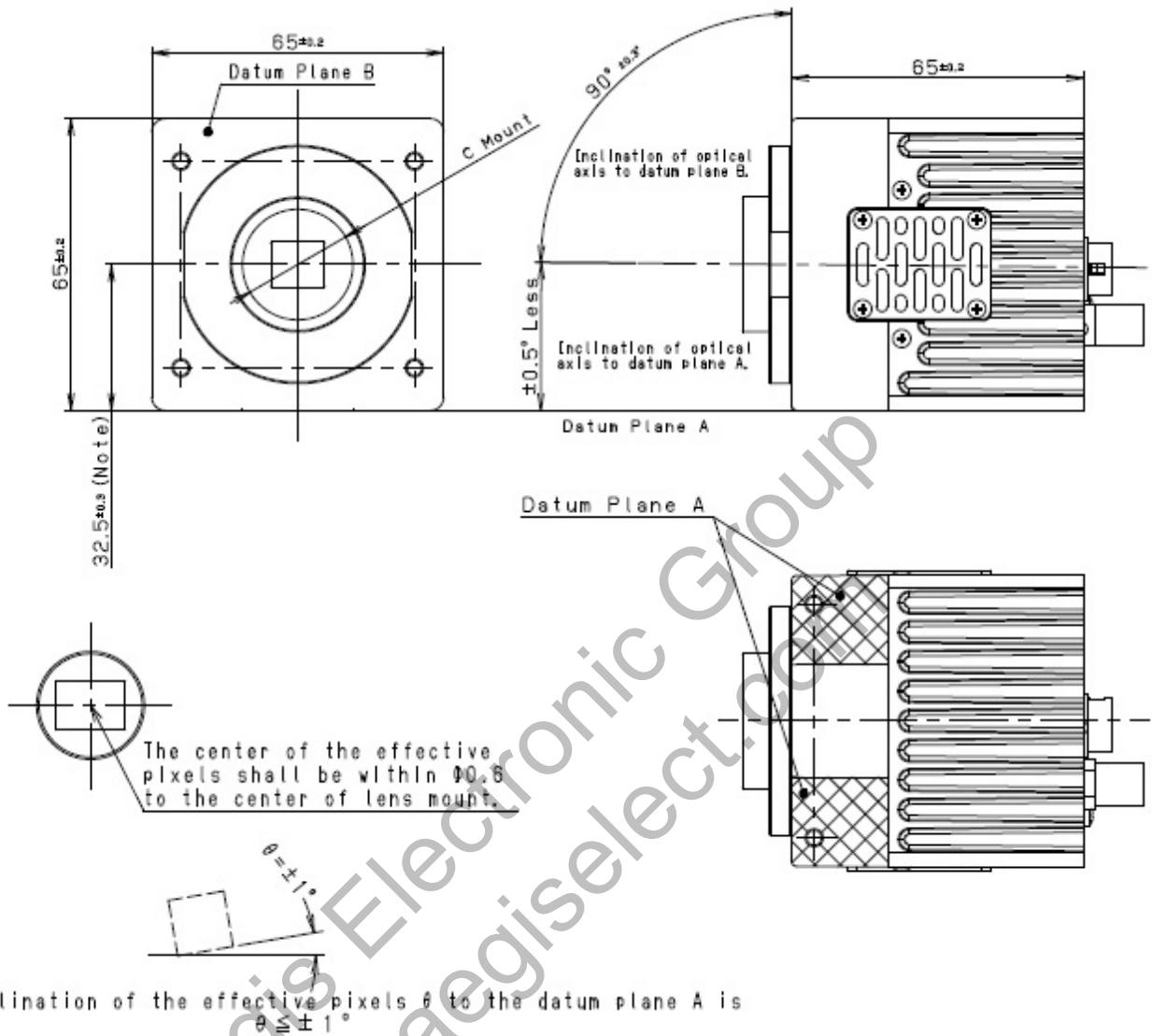

937-0035-00
(Unit: mm)

7. Case for Indemnity (Limited Warranty)

7.1. Product Warranty

The term of warranty of this product is within 3 years from the date of shipping out from our factory.

If you use the product properly and discover a defect during the warranty period, and if that was caused by designing or manufacturing, CIS Corporation, at its option, repairs or replaces it at no charge to you. Products out of warranty period will be subject to charge.

CIS should not hold responsible for damages or losses if;

- damages or losses are caused by earthquake, lightning strike, fire, flood or other acts of God.
- damages or losses are caused by deliberate or accidental misuse by user, or failure to observe the information contained in the instructions in this Product Specification and Operational Manual.
- damages or losses are caused by repair or modification conducted by customer or any unauthorized party.

7.2. CMOS Defective Pixels

CIS applies defective pixel correction prior to the shipment of the product. However, the number of defective pixels are subject to increase, and some defect level of pixels are subject to rise due primarily to the effect of cosmic rays.

Especially with the image sensor used for this model, defective pixels will significantly increase according to the condition of gain, exposure time, and operating temperature. Camera holds function to reduce this phenomenon to some extent, however this phenomenon is unavoidable due to the image sensor characteristics. Due to this nature, CIS should not hold responsible for the natural increase of defective pixels.

7.3. Product Support

Should you have any problems in function of the product you purchased, and if you need our further analysis and/or repair, please contact your local distributor.

8. Appendix : Points to Note on Image Quality Characteristics

Image sensor of VCC-SXCXP1SW contains InGaAs (Indium Gallium Arsenide) elements to acquire sensitivity in SWIR wavelength range. This makes image quality of VCC-SXCXP1SW significantly different from those with standard silicon CMOS image sensors.

With image quality prioritized applications, recommendation to use is ClockSync mode where overlapping operation (Exposure Readout Overlap) is invalid. With overlapping operation, following issues are concerned.

1. White pixel defects

White pixel defects significantly increase under the following conditions.

- a) With gain more than approx. x8 (x2 with 8bit mode)
- b) With long exposure time more than approx. 20ms.
- c) With temperature rise of image sensor.

※ Please make sure to take appropriate heat dissipation measures to keep operational temperature as low as specified in this manual.

VCC-SXCXP1SW features impulse-noise-filter function against white defective pixels.

2. Fixed pattern noise

With gain more than x8 (x2 with 8bit mode), fixed pattern noise as quasi-frosted glass image may appear.

3. Difference in luminance level

With overlapping operation (Exposure Readout Overlap), which starts the next exposure while outputting current data, differences in luminance level may occur in images due to shutter timing. (Only with LineSync mode).

4. Variation in black level

High gain setting causes variation in black level. With more than x128 gain setting in 10/12bit mode and x32 gain setting in 8bit mode, it will be difficult to identify the object.

5. Shading (Dark shading)

Compared to cameras with standard silicon CMOS image sensors, dark shading appears noticeable. Please apply shading correction function as needed.

6. Instability in luminance level with initialization

Upon starting up camera or immediately after changing operational mode, luminance level of video output for 1 frame to 3 frames become unstable. Please wait until luminance level becomes stable.