

INFINITY8 Camera Series

Digital Microscope Cameras

High performance compact microscope cameras that provide both monochrome and vivid color images for a wide range of applications

Teledyne Lumenera's INFINITY8 Microscope Camera Series range in resolution from 2MP to 20MP using the latest in advanced CMOS sensor technology for a wide range of imaging applications from low cost fluorescence imaging to ultra high-resolution stereo microscopy. These cameras are designed to provide both performance and value in today's climate of increasingly constrained lab budgets.



Software

Like all INFINITY Microscope Cameras, INFINITY8 Microscope Cameras include a licence for [INFINITY ANALYZE 7](#), the latest version of Teledyne Lumenera's powerful microscopy software for both brightfield and fluorescence imaging, image stitching, measurements, annotation, time lapse, video clips, and post-processing functions.

High-Performance

The INFINITY8 series offer several models for microscopy. Providing exceptional low light sensitivity for routine fluorescence, brightfield, darkfield, high-resolution, and high-speed imaging. With both color and monochrome models available. All color models include an IR-cut off filter for higher color fidelity.

Design

The INFINITY8 microscopy cameras have a sleek new camera body with a heat-dissipating design to reduce noise without the need for expensive cooling or fans. The sensors selected for the new INFINITY8 camera series rival legacy CCD cameras at a fraction of the price.

Versatility

The INFINITY8 cameras range from monochrome for cost-effective fluorescence imaging to ultra high-resolution color for stereo microscopy - and are compatible with all C-mount microscope brands. Breathe life into your existing microscope by adding a new camera to save time and improve workflow.

INFINITY8 CAMERA SERIES SPECIFICATIONS

	Active Resolution	Sensor Model	Frame Rate**	Pixel Size	Full Well Charge	Read Noise	Dynamic Range	Optical Format	Coupler Magnification	Part Number
 INFINITY8-2M	1608 x 1104	Sony IMX432 (1.7M)	96 fps	9.00 µm	100.4K e- (19.2K e-***)	21.6 e- (4.4 e-***)	72 dB	1.1"	1x	i8-LM00-02M
 INFINITY8-3C	1944 x 1472	Sony IMX429 (2.9M)	62 fps	4.50 µm	24.9K e-	7.2 e-	72 dB	2/3"	0.63x - 0.67x	i8-LC00-03M
 INFINITY8-3M	1944 x 1472	Sony IMX429 (2.9M)	62 fps	4.50 µm	24.9K e-	7.2 e-	72 dB	2/3"	0.63x - 0.67x	i8-LM00-03M
 INFINITY8-8C	3840 x 2160	Sony IMX334 (8.3M)*	44 fps	2.00 µm	7.03K e-	2.0 e-	73 dB	1/1.8"	05x - 0.63x	i8-LC00-08M
 INFINITY8-8M	3840 x 2160	Sony IMX334 (8.3M)*	44 fps	2.00 µm	7.03K e-	2.0 e-	73 dB	1/1.8"	05x - 0.63x	i8-LM00-08M
 INFINITY8-9C	4112 x 2176	Sony IMX267 (8.9M)	31 fps	3.45 µm	10.6K e-	2.3 e-	73.3 dB	1"	1x	i8-LC00-09M
 INFINITY8-9M	4112 x 2176	Sony IMX267 (8.9M)	31 fps	3.45 µm	10.6K e-	2.3 e-	73.3 dB	1"	1x	i8-LM00-09M
 INFINITY8-20C	5472 x 3648	Sony IMX183 (20M)*	19 fps	2.40 µm	14.6K e-	3.25 e-	73 dB	1"	1x	i8-LC00-20M

* Rolling Shutter sensors
 ** Maximum sustainable FPS
 *** High Conversion Gain (HCG) mode

**INFINITY8 CAMERA SERIES SPECIFICATIONS
 (COMMON TO ALL MODELS)**

INFINITY8 Microscopy Cameras	
Camera Interface	USB3.1 (5 Gbit/s)
Exposure Control	Manual and automatic control
Data Format	8 or 12-bit
I/O Ports	Support for input trigger and strobe out
Image Buffer	128 MB
Lens Mount	C mount
Size (L x H x W)	41.5 mm (max) x 45 mm x 45 mm
Mass	108 g
Operating Temp	0 to 50 °C
Power Supply	5V via Power Over USB3 Cable
Power Dissipation	2.3 W to 3.6 W
Data Connector	USB3 Type micro-B (Locking Connector supported)
I/O Connector	JST# SM09B-NSHSS-TB (mating part: JST # NSHR-09V-S), GPIO cable available as an accessory
Software Platform	Teledyne Lumenera INFINITY ANALYZE 7, supported on both Windows and Mac, supported third-party plug-ins for MetaMorph and MicroManager
Included In The Box	INFINITY Microscope Camera, USB3 Micro-B to Type-A Cable (3 Meter/ 9.75 feet)

RESPONSIVITY GRAPHS

INFINITY8-8 Color

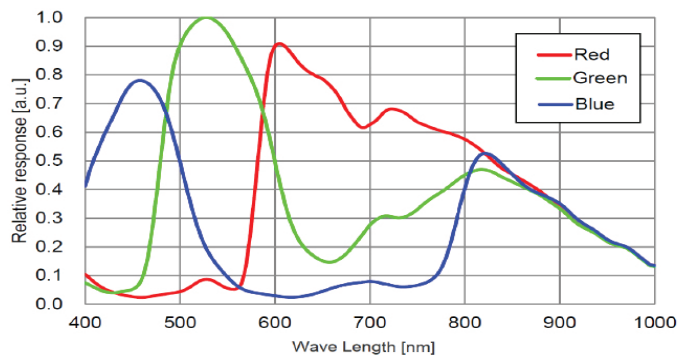

INFINITY8-8 Mono

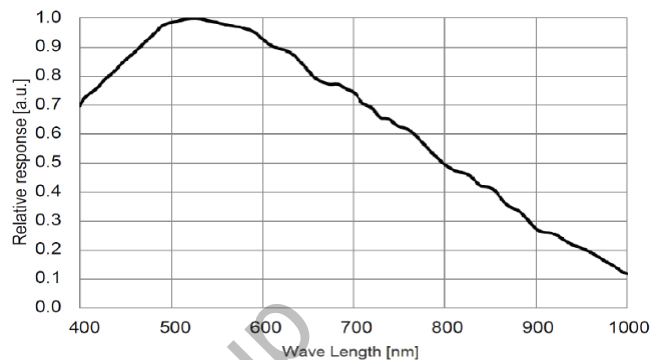

INFINITY8-20 Color

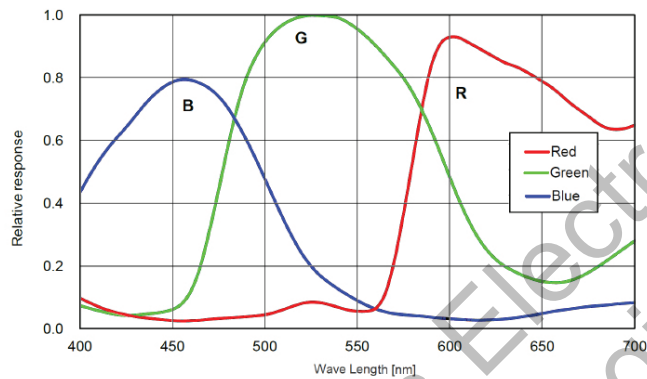

INFINITY8-2 Mono

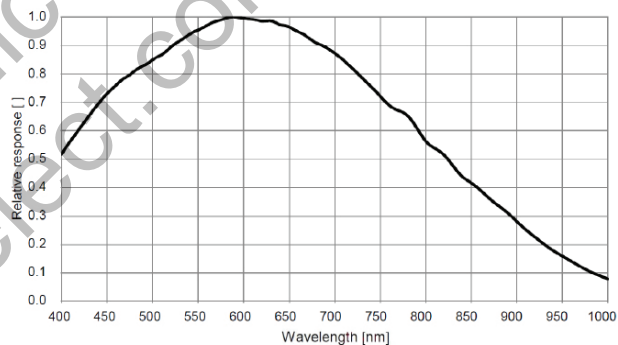

IMAGES CAPTURED WITH INFINITY8 CAMERAS

40X magnification with an INFINITY8-8C

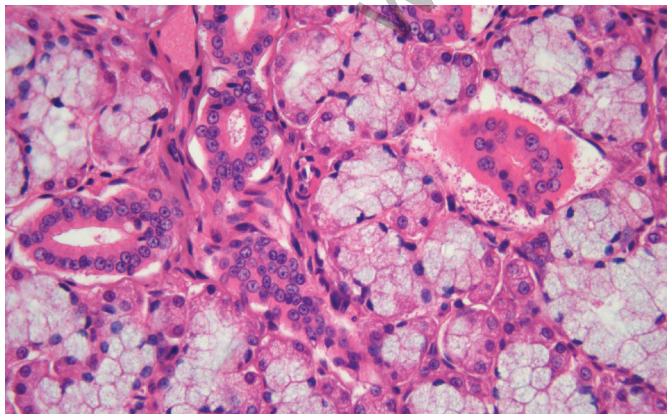

60X magnification with an INFINITY8-2M

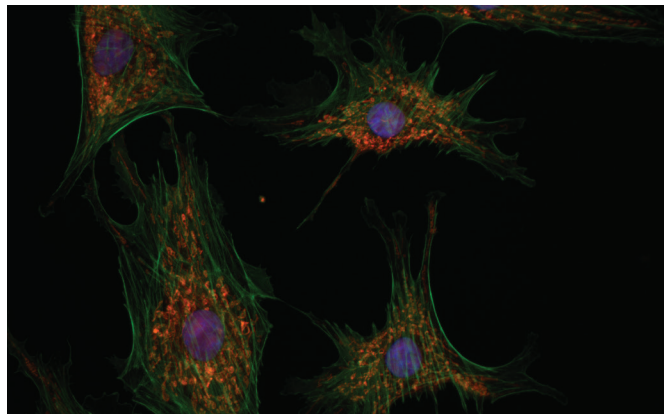

RESPONSIVITY GRAPHS

INFINITY8-3 Color

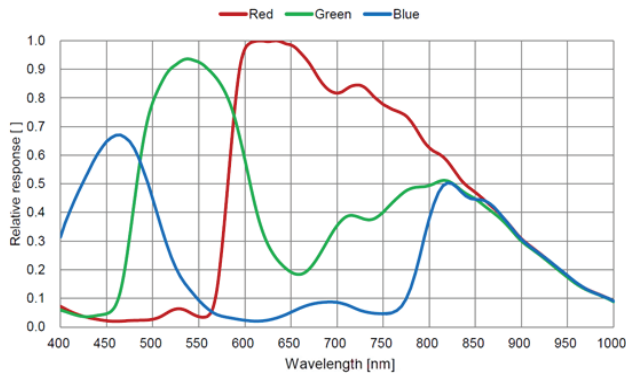

INFINITY8-3 Mono

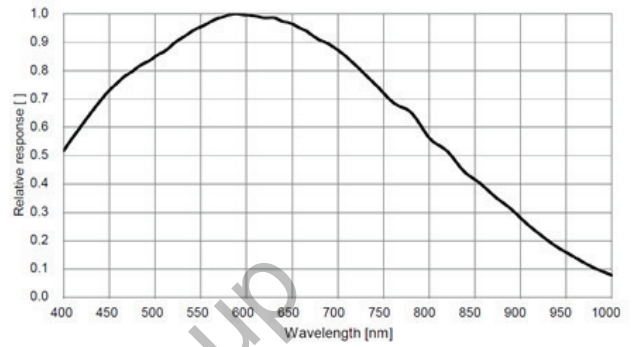

INFINITY8-9 Color

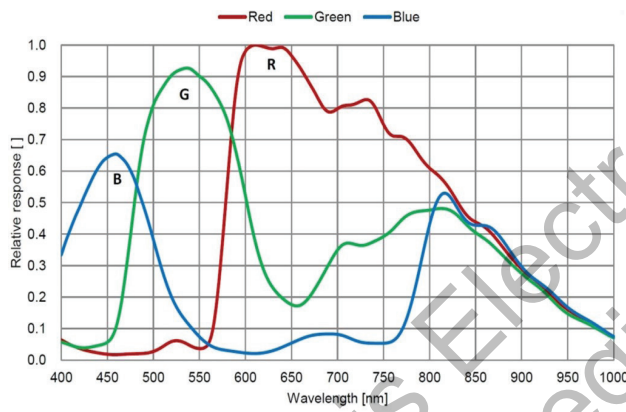

INFINITY8-9 Mono

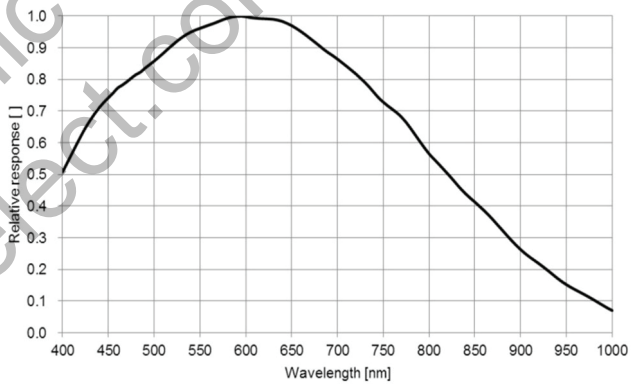

INFINITY8 Camera Series Specifications

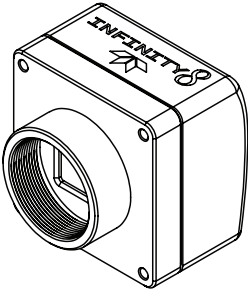
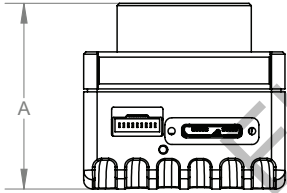
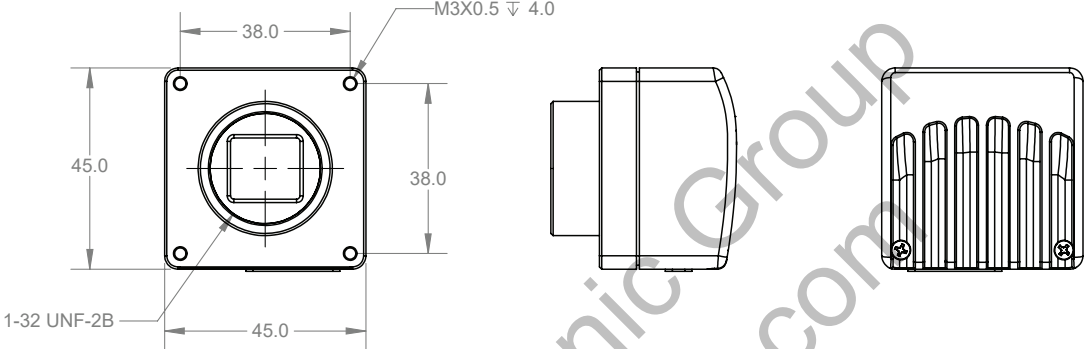

MODELS	DIMENSION
	A
INFINITY8-2	41.5
INFINITY8-3	
INFINITY8-9	
INFINITY8-20	
INFINITY8-8	38.5



Microscopy cameras featuring Sony Pregius & Starvis sensors