

MC-308B

2MP High Resolution 30x Zoom Module

HD-SDI EX-SDI HD-TVI CVBS



Features

- 1/2.8" 2MP Sony CMOS Sensor
- 1080p 60fps/30fps, 720p 60fps/30fps
- 30x Optical Zoom(4.6mm~136mm) & 32x Digital Zoom
- Day & Night(ICR)
- Wide Dynamic Range
- Digital Noise Reduction(2D+3D)
- Digital Image Stabilization
- Privacy Mask Function
- High Light Compensation
- Intelligent Motion Detection
- Defog Function
- Supports VISCA, Pelco-D/P Protocol
- Video Out : HD-SDI, EX-SDI, HD-TVI, CVBS

Dimensions

Unit : mm

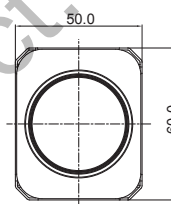

FRONT

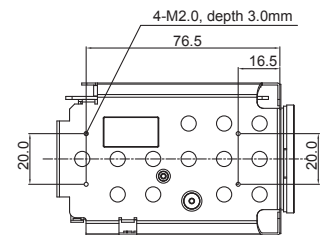

LEFT SIDE

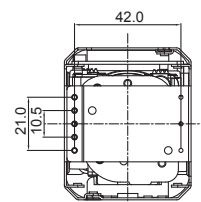

BACK

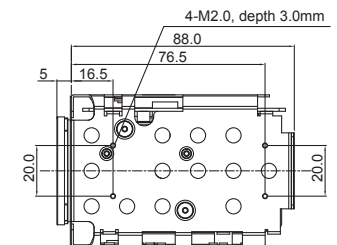

RIGHT SIDE

Field of View

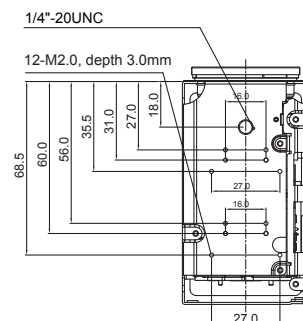
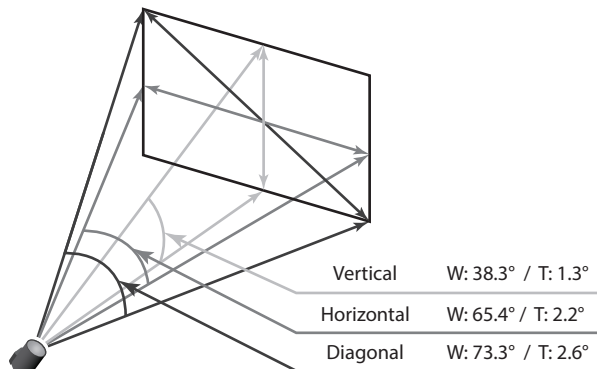

BOTTOM

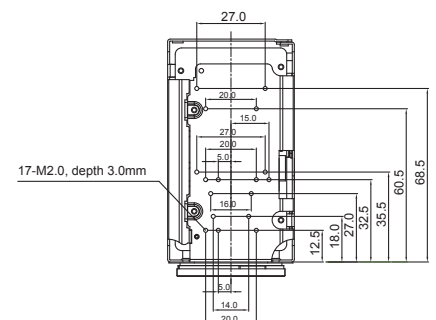

TOP

Specifications

MC-308B				
Image Sensor	1/2.8" Sony CMOS Sensor			
Total Pixels	1,945 (H) x 1,109 (V) = 2.16M Pixels			
Active Pixels	1,945 (H) x 1,097 (V) = 2.13M Pixels			
Scanning System	Progressive Scan			
Sync. System	Internal			
Resolution	Digital : 1080p/60(50)fps, 1080p/30(25)fps, 720p/60(50)fps, 720p/30(25)fps			
	Analog : 700TVL			
Min. Illumination	Color(1/30s, 79.5dB) : 0.005 lux, BW(1/30s, 79.5dB) : 0.0008lux			
	Color DSS(1/8s, 79.5dB) : 0.00125 lux, BW DSS(1/8s, 79.5dB) : 0.0002 lux			
Video Output	HD : HD-SDI, EX-SDI			
	Analog : VBS(without WDR), HD-TVI			
S/N Ratio	more than 50dB (AGC off)			
Lens Type	30x Day & Night Zoom Lens			
Zoom Ratio	Optical 30x, Digital 32x Zoom			
Focal Length	f = 4.6 mm ~ 136.0 mm			
Aperture Ratio	F1.63(wide) ~ F4.85(tele)			
Angle Of View(D, H, V)	Wide	73.3°(±5%)	65.4°(±5%)	38.3°(±5%)
	Tele	2.6°(±5%)	2.2°(±5%)	1.3°(±5%)
AF Mode	Auto / One Push / Manual			
Min. Distance	0.5 / 1.5 / 3.0 / 5.0 / 10.0 m			
Lens Refresh	One Push / 1 ~ 10Day			
Digital Zoom	Off / MAX 2x ~ 32x			
Exposure	Auto / Iris.P / Shut.P / Manual			
Gain Control(AGC)	Off / On			
Shutter Speed	1/30(25) ~ 1/30,000 sec			
Iris	0 ~ 20 steps			
Digital Slow Shutter(DSS)	Off / x2 / x4 (/ x8 : 60 or 50 fps mode only)			
Brightness	0 ~ 20 steps			
WDR/BLC	Off / WDR / BLC			
Day&Night	Auto / Day / Night / Ext-in			
White Balance	Auto / One Push / Manual / Indoor / Outdoor			
HLC	Off / On / Night Only			
DNR	Auto / Off / Low / Middle / High			
Mirror	Off / H / V / H&V			
Sharpness	0 ~ 10 steps			
ACE	Off / Low / Middle / High			
Defog	Off / On(Auto / Manual)			
Privacy Mask	Max. 24 Areas			
Motion Detection	Max. 3 Areas			
Defect Detection	Off / On			
System	NTSC / PAL			
Communication	Baud Rate : 2400 / 4800 / 9600 / 19200 / 38400 / 57600 / 115200			
	Protocol : VISCA / Pelco-D / Pelco- P / Update			
Language	English / Simplified Chinese / Traditional Chinese / Japanese			
Power Source	9V to 15V DC			
Power Consumption	500mA			
Power Input	Connector			
Video Output	Connector			
Storage Temperature	-20℃ ~ +60℃ (Humidity : 0%RH ~ 90%RH)			
Operating Temperature	-10℃ ~ +50℃ (Humidity : 0%RH ~ 90%RH)			
Dimensions	50(W) x 60(H) x 93(D)			
Weight	278g			

* Design and specifications are subject to change without notice.

Pin Assignment

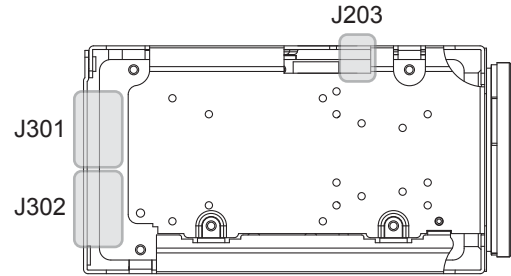

J301		J302		
1	TVI-OUT	1	RxD	
2	GND	2	TxD	
3	VBS-OUT	3	GND	
4	GND	4	DC+12V	
5	NC	5	GND	
6		6	VBS-OUT	
7		7	GND	
8		8	TVI-OUT	
9		9	GND	
10				
11				
12				
13				
14				
15				
16	+5V OUT			
17	GND			
18	GND			
19	DC+12V			
20	DC+12V			
21	DC+12V			
22	GND			
23	GPIO2			
24	GPIO1			
25	ADKEY(OSD Control)			
26	D/N-IN			
27	IR-ON			
28	MD-OUT			
29	RS-485(-)			
30	RS-485(+)			

Ref 10019HR-09(YEONHO)

J203	
-	HD-SDI

Ref MMCX-R/A

Ref USL00-30L-C(KEL Cop.)