

Draft Ver.

# MC-G105

Global Shutter 10x Zoom Module

LVDS CVBS



## Features

- 1/3.1" 3MP Sony CMOS Sensor
- 1080p 60/30fps, 720p 60/30fps
- 10x Optical Zoom(4.7mm~47mm) & 32x Digital Zoom
- Day & Night(ICR)
- Digital Noise Reduction(2D+3D)
- Privacy Mask Function
- Digital Image Stabilization
- High Light Compensation
- Intelligent Motion Detection
- Defog Function
- Supports VISCA, Pelco-D/P Protocol
- Video Out : LVDS, CVBS

## Field of View

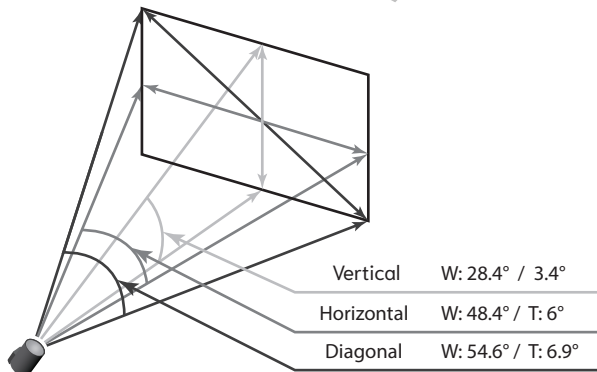

## Dimensions

Unit : mm

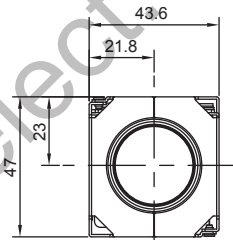

FRONT

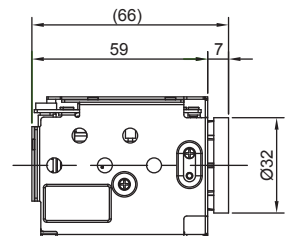

LEFT

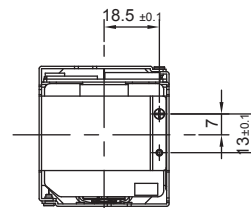

BACK

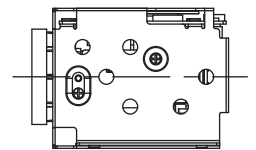

RIGHT

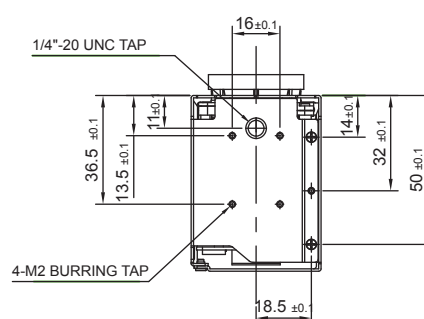

BOTTOM

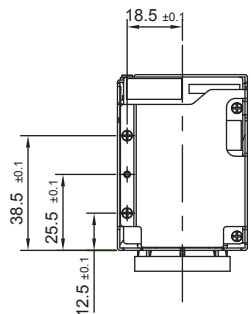

TOP

# Specifications

MC-G105				
Image Sensor	1/3.1" Sony CMOS Sensor			
Total Pixels	2,064 (H) x 1,592 (V) = 3.28M Pixels			
Active pixels	2,064 (H) x 1552 (V) = 3.20M Pixels			
Scanning System	Progressive Scan			
Sync. System	Internal			
Resolution	Digital : 1080p/60(50)fps, 1080p/30(25)fps, 720p/60(50)fps, 720p/30(25)fps			
	Analog : CVBS			
Min. Illumination(50%)	Color(1/30s, 79.5dB) : 0.1 lux , BW(1/30s, 79.5dB) : 0.01 lux			
	Color DSS(1/1s, 79.5dB) : 0.01 lux , BW DSS(1/1s, 79.5dB) : 0.001 lux			
Video Output	Digital : LVDS			
	Analog : CVBS			
S/N Ratio	more than 50dB(AGC off)			
Lens Type	10x Day & Night Zoom Lens			
Zoom Ratio	Optical 10x, Digital 32x Zoom			
Focal Length	f = 4.7mm ~ 47mm			
Aperture Ratio	F1.7(wide) ~ F3.1(tele)			
Angle Of View(D, H, V)	Wide	54.6°	48.4°	28.4°
	Tele	6.9°	6°	3.4°
Trigger Polarity	Active Low / Active High			
Trigger Delay	0 ~ 255.9ms			
Strobe Polarity	Active Low / Active High			
Strobe Delay	Ext-Trigger : 0 ~ 255.9ms / Free run : 0 ~ (1V period - Width)ms			
Strobe Width	Ext-Trigger : 0 ~ 255.9ms / Free run : 0 ~ (1V period - Delay)ms			
Shutter Speed(Ext-trigger)	1/30(25) ~ 1/40,000 sec			
AGC(Ext-trigger)	0 ~ 10 steps			
Iris(Ext-trigger)	Close ~ F1.7			
Day&Night(Ext-trigger)	Day / Night			
AF Mode	Auto / One Push / Manual			
Min. Distance	1.0 / 2.0 / 3.0 / 5.0 / 10.0 m			
Lens Refresh	One Push / 1 ~ 10Day			
Digital Zoom	Off / MAX 2x ~ 32x			
Exposure	Auto / Iris.P / Shut.P / Manual			
Digital Slow Shutter(DSS)	Off / 2x / 4x / 8x / 16x / 32x (/64x : 60 or 50fps mode only)			
Brightness	0 ~ 14 steps			
Back Light	Off / BLC / HLC			
White Balance	Auto / One Push / Manual / Indoor / Outdoor / Auto-Ext			
DNR	2D/3D, 2D+3D			
Mirror	Off / H / V / H&V			
Sharpness	0 ~ 15 steps			
DWDR	Off / Manual / Auto			
Defog	Off / Manual / Auto			
Privacy Mask	Off / On (8 points)			
Motion Detection	Off / On (4 points)			
Defect Detection	Off / On			
System	NTSC / PAL			
Communication	Baud Rate : 2400 / 4800 / 9600 / 19200 / 38400 / 57600 / 115200			
	Protocol : Pelco-P / Pelco-D / VISCA			
Power Source	9V to 15V DC			
Power Consumption	MAX 430mA (@ 12VDC)			
Power Input	Connector			
Video Output	Connector			
Storage Temperature	-20℃ ~ +60℃ (Humidity : 0%RH ~ 90%RH)			
Operating Temperature	-10℃ ~ +50℃ (Humidity : 0%RH ~ 90%RH)			
Dimensions	43.6(W) x 47(H) x 66(D)			
Weight	165g			

# Pin Assignment

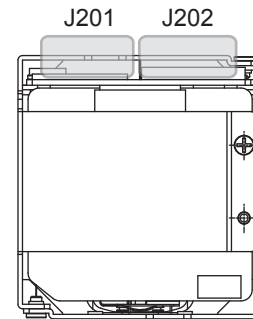

J201	
1	TXOUT3+
2	TXOUT3-
3	TXCLKOUT+
4	TXCLKOUT-
5	TXOUT2+
6	TXOUT2-
7	TXOUT1+
8	TXOUT1-
9	TXOUT0+
10	TXOUT0-
11	GND
12	TxD
13	RxD
14	DC IN
15	DC IN
16	DC IN
17	DC IN
18	DC IN
19	GND
20	GND
21	TXOUT7+
22	TXOUT7-
23	TXOUT6+
24	TXOUT6-
25	TRIG_IN
26	STROBE_OUT
27	TXOUT5+
28	TXOUT5-
29	TXOUT4+
30	TXOUT4-

J202	
1	GND
2	TxD
3	RxD
4	TRIG_IN
5	GND
6	STROBE_OUT
7	GND
8	ADKEY
9	NC
10	D/N-IN
11	NC
12	MD-OUT
13	485-DIR
14	NC
15	GND
16	+5V
17	GND
18	CVBS-OUT
19	GND
20	DC IN
21	DC IN
22	DC IN
23	DC IN
24	DC IN

Ref 05002HR-24J05 (YEONHO)

Ref USL00-30L-C (KEL Cop.)

\* Design and specifications are subject to change without notice.