

---

# PoCL CameraLink Monochrome / Color CMOS Camera

STC-SPB500PCL (5.0M / Monochrome / Low speed)  
STC-SPC500PCL (5.0M / Color / Low speed)

Product Specifications and User's Guide

Aegis Electronic Group, Inc.

---

 (888)687-6877  
ELECTRONIC GROUP, INC  
aegis-g2@aegiselect.com

**OMRON SENTECH CO., LTD.**

# Table of Contents

<b>1</b>	<b>Product Precautions</b> .....	<b>6</b>
<b>2</b>	<b>Warranty</b> .....	<b>6</b>
<b>3</b>	<b>Overview</b> .....	<b>7</b>
<b>4</b>	<b>Features</b> .....	<b>7</b>
<b>5</b>	<b>Specifications</b> .....	<b>8</b>
5.1	Electronic specifications .....	8
5.2	Spectral Sensitivity Characteristics .....	10
5.2.1	STC-SPB500PCL.....	10
5.2.2	STC-SPC500PCL.....	10
5.3	Mechanical specifications.....	11
5.4	Environmental specifications .....	11
5.5	Connector specifications .....	12
5.5.1	Camera Link connector .....	12
5.5.2	Power / I/O connector .....	13
5.5.3	Input signal circuit.....	14
5.5.4	Output signal circuit.....	14
<b>6</b>	<b>Dimensions</b> .....	<b>15</b>
<b>7</b>	<b>Sensor Information</b> .....	<b>16</b>
<b>8</b>	<b>Camera Output Timing Charts</b> .....	<b>17</b>
8.1	Horizontal timing: Full scanning, binning operation.....	17
8.1.1	2TAP (1X2-1Y) / Horizontal: 2,448 pixels.....	17
8.1.2	3TAP (1X3-1Y) / Horizontal: 2,448pixels.....	17
8.2	Horizontal timings: Decimation operation.....	18
8.2.1	2TAP (1X2-1Y) .....	18
8.2.2	3TAP (1X3-1Y) .....	18
8.3	Vertical timings .....	19
<b>9</b>	<b>Scanning Modes</b> .....	<b>20</b>
9.1	ROI output timing.....	20
9.2	Decimation.....	21
9.3	Binning.....	21
<b>10</b>	<b>Image Data Transferring Speed</b> .....	<b>22</b>
10.1	Extend horizontal cycle.....	22
10.2	Change transferring clock .....	22
<b>11</b>	<b>Camera Function Modes</b> .....	<b>23</b>
11.1	Free-run / Continuous mode .....	--
11.1.1	Full frame exposure.....	--
11.1.2	Electronic shutter.....	--
11.2	Pulse width trigger mode.....	--
11.3	Edge Preset Trigger mode .....	--
11.4	Exposure Timing Details.....	--
11.4.1	Fast trigger mode .....	--
11.4.2	Trigger overlap mode .....	--
11.4.3	Exposure timing for each mode .....	--
<b>12</b>	<b>Camera Function</b> .....	
12.1	Lookup table (Gamma).....	
<b>13</b>	<b>Communication Protocol specifications</b> .....	
13.1	Communication method.....	

**(888)687-6877**  
 ELECTRONIC GROUP, INC  
[aegis-g2@aegiselect.com](mailto:aegis-g2@aegiselect.com)



---

13.2	Communication settings .....	28
13.3	Communication format .....	29
13.4	Camera control commands .....	30
13.4.1	Camera control commands list.....	30
13.4.2	Description of the camera control commands (Bank No.: 00H).....	33
13.4.3	Description of the camera control commands (Bank No.: 01H).....	37
13.4.4	Command sequence for the data saves to the EEPROM.....	38
14	<b>Revision History</b> .....	<b>39</b>

Aegis Electronic Group, Inc.

---

*Aegis* (888)687-6877  
ELECTRONIC GROUP, INC  
aegis-g2@aegiselect.com

## Precautions for safe use

Please read carefully this "Precautions for safe use" before use the camera. Then the camera uses correctly with agreeing with below notes.

In this "Precautions for safe use", notes divides into "Warning" and "Caution" to use the camera safety and prevent to harm and damage.

	<b>Warning</b>	This shows, assumption for possibility of serious accident leading death or serious injury if ignore this note and camera uses incorrectly.
	<b>Caution</b>	This shows, assumption for possibility of bear the damage or physical damage if ignore this note and camera uses incorrectly.

About Graphic symbols



This symbol shows general prohibition.



This symbol shows completion or instruction.

### [Environment / condition]

<b>Warning</b>	
	Do not use flammable or explosiveness atmospheres. This will cause of personal injury or fire.
	Do not use for "safety for human body" related usage. This camera is designed for use "do not harm human body immediately" if by any chance the camera has malfunction.
<b>Caution</b>	
	Use and store under specified environmental conditions (Vibration, shock, temperature, humidity) in the specifications for this camera. This will cause of fire or damage the camera.









### [Installation and cable wiring]

<b>Warning</b>	
	Do not use with out of power voltage range that is specified in the specifications for this camera. This will cause of fire, electrification or malfunction.
	Do not wrong wiring. This will cause of fire or malfunction.

<b>Caution</b>	
	Do not grounding DC power (+) of all devices that are connect to the camera. The camera housing is connecting to 0 V line of camera inside circuit. There is a risk of short circuit between camera inside ciurcuit and frame ground. This will cause of malfunction.
	It is necessary to wiring with turn off the camera This will cause of electrification or malfunction.
	Do not use Camera Link un-supported cable and board. There is a risk of malfunction if the camera connects with wrong environment and turn on the camera.

*Aegis* (888)687-6877  
ELECTRONIC GROUP, INC  
aegis-g2@aegiselect.com



[Usage instruction]

 <b>Warning</b>	
 Do not touch the terminal and PCB board While turn on the camera. This will cause of electrification or accident caused by malfunction.	 Do not put combustibles near the camera. This will cause of fire.
 Do not use without usage that is specified in the specifications for this camera. This will cause of personal injury or malfunction.	 Do not push metals including screw driver into radiation holes. This will cause of electrification or malfunction.
 <b>Caution</b>	
 Do not push contamination into opening of the camera. This will cause of electrification or malfunction.	 Do not block the radiation holes. This will cause of fire due to increase the camera inside temperature.

[Maintenance]

 <b>Caution</b>	
 Do not disassemble or repair the camera. This will cause of fire, electrification or malfunction.	 It is turn off the camera when maintaining or inspecting the camera. This will cause of electrification.

[Disposal]

 <b>Caution</b>	
 It is necessary to dispose as industrial waste.	

Aegis Electronic Group, Inc.

 **(888)687-6877**  
**ELECTRONIC GROUP, INC**  
**aegis-g2@aegiselect.com**

## 1 Product Precautions

Do not give shock to the camera.

Do not haul or damage the camera cable.

Do not wrap the camera with any material while using the camera. This will cause the internal camera temperature to increase.

When the camera moving or using the place that temperature difference is extreme, countermeasure for dew condensation (heat removal / cold removal) is necessary.

While the camera is not using, keep the lens cap on the camera to prevent dust or contamination from getting in the sensor or filter and scratching or damaging it.

Do not keep the camera under the following conditions.

In wet, moist, high humidity or dusty place

Under direct sunlight

In extreme high or low temperature place

Near an object that releases a strong magnetic or electric field

Place with strong vibrations

Apply the power that satisfies the specified in specifications for the camera.

The defective pixels may appear due to the sensor characteristics.

Use below recommend materials (or equivalent materials) to clean the surface of glass.

Air dust: Non Freon air duster (NAKABAYASHI Co., LTD.)

Alcohol: Propan-2-ol (SAN'EI KAKO Co., LTD.)

Non-woven: nikowipe clean room (NKB)

Use a soft cloth to clean the camera.

## 2 Warranty

### ■Warranty period

One year after delivery (However, the camera had malfunction with camera uses correctly)

In below case for a fee even within warranty period.

- The malfunction caused by incorrect usage, incorrect modify or repair.
- The malfunction caused by external shock including the camera dropping after delivery the camera.
- The malfunction caused by fire, earthquake, flood disaster, thunderbolt struck, other natural disaster or wrong voltage.

### ■Warranty coverage

Exchange or repair the malfunction camera if the malfunction is occurred by our responsibility.

“Warranty” mean is warranty for the delivered camera itself. Please accept the induction damage by the camera malfunction is not included.

 (888)687-6877

ELECTRONIC GROUP, INC  
aegis-g2@aegiselect.com

### 3 Overview

This camera is the 5.0 Mega pixels global shutter CMOS sensor with the Camera Link interface camera.

This camera has the external trigger function to obtain the fast moving target image for the machine vision usage.

### 4 Features

- High resolution  
The camera has Sony Pregius 5.0 Mega pixels global shutter CMOS sensor to achieve the maximum 35.7 fps at 3TAP 8bits output.
- Camera Link standard (PoCL) compliance  
The camera is compliance with the Camera Link base configuration (3TAP 8bits, 2TAP 8bits, 2TAP 10bits and 2TAP 12bits).  
The camera power can be supply from the PoCL supported Camera Link frame grabber board.
- Global shutter  
The camera has Sony Pregius 5.0 Mega pixels global shutter CMOS sensor to support obtaining fast moving target image.
- Fast exposure time  
The minimum 1μseconds fast exposure time is supported for the free-run / continuous mode and edge preset trigger mode.
- Trigger operation  
Expose and obtain the image by the external trigger signal through CC1 on Camera Link or 2pin on the power / I/O signal connector.
- ROI (Region Of Interest)  
The frame rate can be increase by the ROI (one region) function.
- Decimation  
The horizontal and vertical thinning image is output. The half resolution (2x2 sub-sampling) without change the view angle, and twice faster frame rate image can be obtained by the decimation function.
- Binning \*only available for the monochrome model  
The brightness of two vertical pixels are summing into one pixel. (No horizontal brightness summing) The twice brighter, half resolution and twice faster frame rate image can be obtained by the binning function.
- Selectable Camera Link clock speed  
The Camera Link clock speed can be selectable from 84.857 MHz, 66 MHz or 39.6 MHz.  
(84.857 MHz, 66 MHz or 33 MHz are selectable with extend horizontal cycle)  
Please select the optimum Camera Link clock speed if the long length Camera Link cable is required.
- Heat dissipation design  
The heat of the electronics components inside of the camera is dissipated to the camera housing with the mechanical design, which is the minimized the thermal resistance between the components and housing.  
Please manage the camera housing temperature when the camera using in the environment exceeding the ambient temperature specified in this specifications.

 (888)687-6877

ELECTRONIC GROUP, INC  
aegis-g2@aegiselect.com

## 5 Specifications

### 5.1 Electronic specifications

Model Number			STC-SPB500PCL	STC-SPC500PCL
Image Sensor			2/3" 5.0M Progressive Monochrome CMOS (Sony: IMX264)	2/3" 5.0M Progressive Color CMOS (Sony: IMX264)
Shutter Type			Global shutter	
Effective Picture Resolution			<b>2,448 (H) x 2,048 (V)</b>	
Cell Size			3.45 (H) $\mu\text{m}$ x 3.45 (V) $\mu\text{m}$	
Sync System			External Trigger (hardware / software) / Free-run (continuous)	
Maximum Frame Rate (at full resolution) (*1)	3TAP Output		<b>35.7 fps</b>	
	2TAP Output		32.8 fps	
ADC Bits			12 bits	
Image Output			<b>8 / 10 / 12 bits</b>	
Camera Link Data Output (*2)			Base Configuration	
Camera Link TAP Configuration			<b>3TAP / 2TAP</b>	
Camera Link Clock Speed (*3)	3TAP Output		<b>66 / 39.6 MHz</b>	
	2TAP Output		84.857 / 66 / 39.6 MHz	
Noise Level (Gain 0 dB) (*4)	8bits Output		Less than 3 digits	
	10bits Output		Less than 12 digits	
	12bits Output		Less than 48 digits	
Sensitivity (*5)			530 Lux	1,160 Lux
Exposure Time (2TAP / 3TAP common)			1 $\mu\text{second}$ to 16.777 seconds ( <b>Default: 1 <math>\mu\text{second}</math></b> )	
Gain	Analog Gain		0 dB to 18 dB ( <b>Default: 0 dB</b> )	
	Digital Gain		x1 to x11.59 ( <b>Default: x1</b> )	
Black Level (*4)	8bits Output		0 to 63 digits	
	10bits Output		0 to 255 digits	
	12bits Output		0 to 1,023 digits	
White Balance Gain			N/A	0 (Black level) to x4 ( <b>Default: x1</b> )
ROI	Size	Horizontal	2TAP: 2 to 2,448 pixels (adjustable unit: 2 pixels) 3TAP: 3 to 2,448 pixels (adjustable unit: 3 pixels) <b>(Default: 2,448)</b>	
		Vertical	4 to 2,048 lines (adjustable unit: 4 lines) ( <b>Default: 2,048</b> )	
	Position	Horizontal	0 to 2,447 pixels (adjustable unit: 1 pixel)	0 to 2,446 pixels (adjustable unit: 2 pixels)
		Vertical	0 to 2,044 lines (adjustable unit: 4 lines)	
Multi ROI				
Gamma				
Binning			Two vertical pixels	
Decimation				
Mirror Image				
Pixel Defect Correction				

Default setting: **Bold**

**(888)687-6877**  
 ELECTRONIC GROUP, INC  
[aegis-g2@aegiselect.com](mailto:aegis-g2@aegiselect.com)

Model Number		STC-SPB500PCL	STC-SPC500PCL
Auto Image Control	Auto Exposure		N/A
	Auto Gain		N/A
	Auto White Balance		N/A
Operating Mode		<b>Edge preset trigger</b> / Pulse width trigger / Free-run (continuous)	
Save User Mode		Support	
I/O Ports		4 I/Os	
Power	Input Voltage	+12 Vdc +/- 10 % (PoCL Support)	
	Consumption	Maximum: 2.6 W, Typical: 2.1 W	

Default setting: **Bold**

### Precautions

(\*1) The selected video output bit does not make any influence for the maximum frame rate.

(\*2) Camera Link data output formats (TAP configuration and output bits) are in below table:

	3TAP	2TAP
8bits	Base configuration	Base configuration
10bits	N/A	Base configuration
12bits	N/A	Base configuration

(\*3) Please select the optimum Camera Link clock speed if the long length Camera Link cable is required. Please refer "The image data transferring speed" for more details.

(\*4) The selected TAP configuration does not make any influence for the noise level and black level.

(\*5) The sensitivity is measured the illumination of the light source for 100% white under below conditions:

Camera Setting		Environment	
Parameter	Setting	Parameter	Setting
Gain Up	0 dB	Light Source	Light Box (White)
AGC	Off	Color temperature	5,100K
White Balance	Optimum	Lens	
Electrical Shutter	1/30 seconds	F on Lens	F5.6
Black Level	Optimum	Target Luminance	IM-600 (Topcon)
Gamma	Factory Setting		

 (888)687-6877

ELECTRONIC GROUP, INC  
aegis-g2@aegiselect.com

## 5.2 Spectral Sensitivity Characteristics

### 5.2.1 STC-SPB500PCL

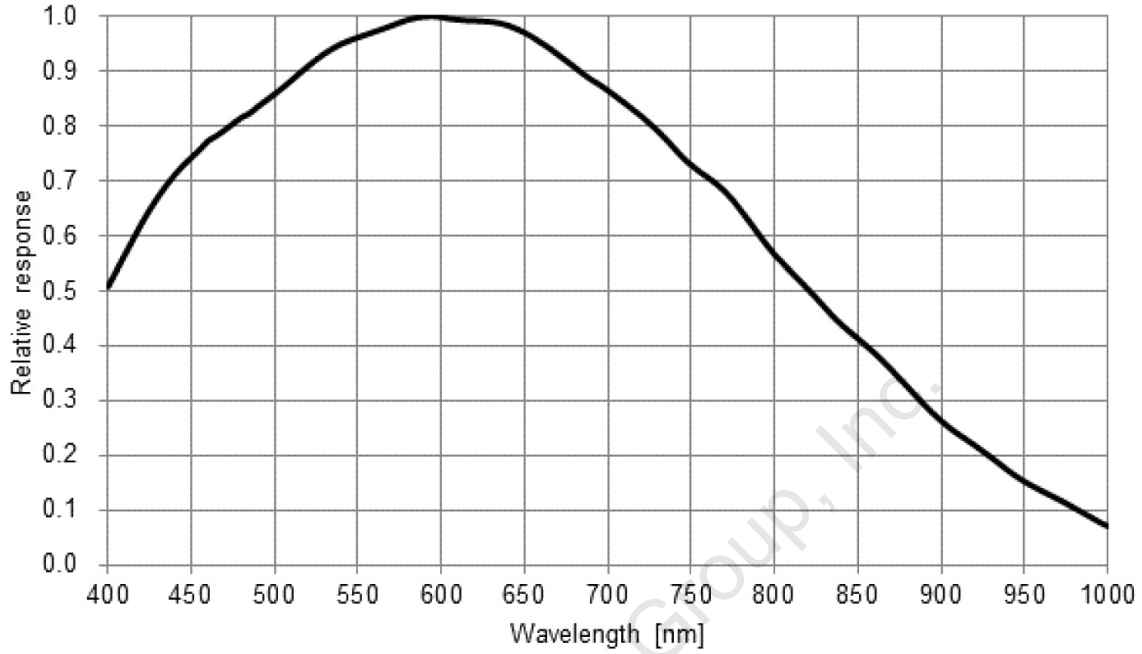

### 5.2.2 STC-SPC500PCL

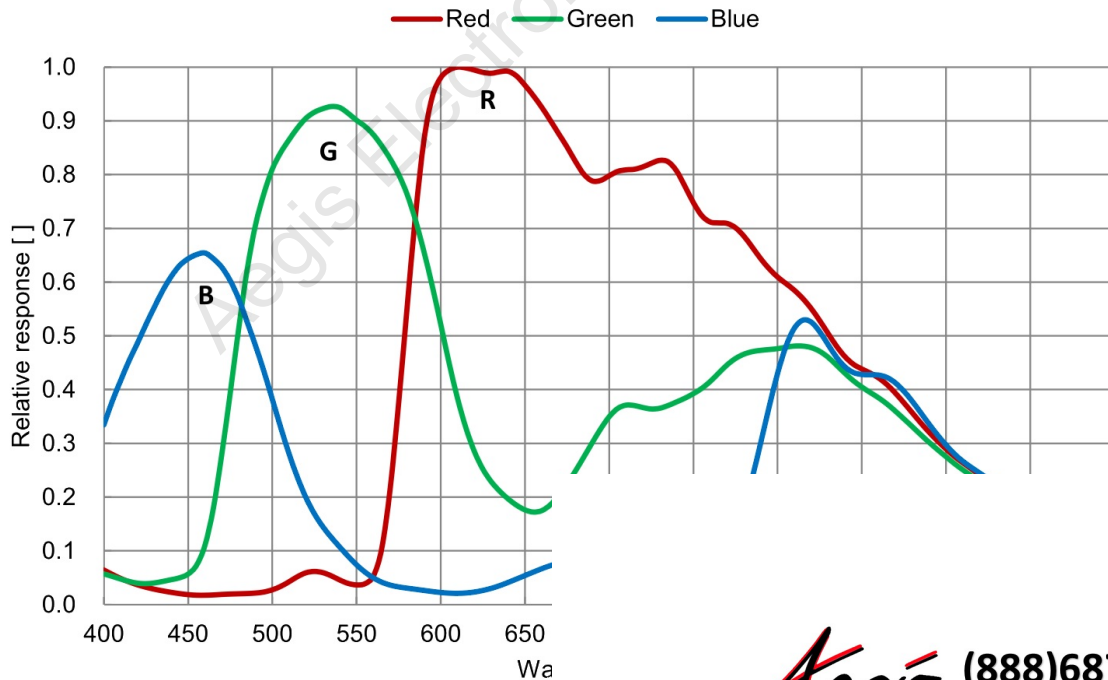

**Aegis** (888)687-6877  
 ELECTRONIC GROUP, INC  
 aegis-g2@aegiselect.com

### 5.3 Mechanical specifications

Model Number	STC-SPB500PCL	STC-SPC500PCL
Dimensions	35 (W) x 35 (H) x 40.7 (D) mm (*1)	
Optical Filter	Non-Optical Filter	
Optical Center Accuracy	Positional accuracy in Horizontal and Vertical directions: +/- 0.3 mm Rotational accuracy in Horizontal and Vertical directions: +/- 1.5 deg.	
Material	Aluminum alloy	
Lens Mount (*2)	C Mount	
Interface Connectors	Camera Link connector: SDR connector (3M) or equivalent x 1 Power / I/O connector: HR10A-7R-6PB (Hirose) or equivalent x 1	
Camera Mounting	1/4" Tripod screw holes (One on top and bottom plates) M4 screws holes (Four on top, bottom and side plates)	
Weight	Approximately 69 g	

(\*1) Excluding the connectors

(\*2) Recommend lens: More than F2.8 (Close side)

### 5.4 Environmental specifications

Model Number	STC-SPB500PCL	STC-SPC500PCL
Operational temperature / Humidity	Environmental temperature: 0 to +45 deg. C (camera housing temperature (top plate): less than +64 deg. C (*1)) Environmental humidity: 0 to 85 %RH (No condensation)	
Storage temperature / Humidity	Environmental temperature: -20 to +75 deg. C Environmental humidity: 0 to 85 %RH (No condensation)	
Vibration	20 Hz to 200 Hz to 20 Hz (5 min. / cycle), acceleration 10 G, XYZ 3 directions 30 min. each	
Shock	Acceleration 38 G, half amplitude 6 ms, XYZ 3 directions 3 times each	
Standard compliancy	EMS: EN61000-6-2, EMI: EN55011	
RoHS	RoHS compliance	

(\*1) Please insure the camera is installed with the appropriate heat dissipation to keep the camera housing temperature (top plate) is less than 64 deg. C when the camera using the ambient temperature is exceeded 45 deg. C. If the camera has a mounted lens and a tripod with an aluminum plate, this could decrease the camera housing temperature for the heat dissipation.

Temperature measuring point

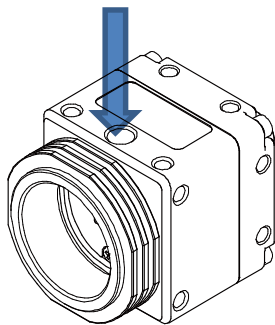

*Aegis* (888)687-6877  
ELECTRONIC GROUP, INC  
aegis-g2@aegiselect.com

## 5.5 Connector specifications

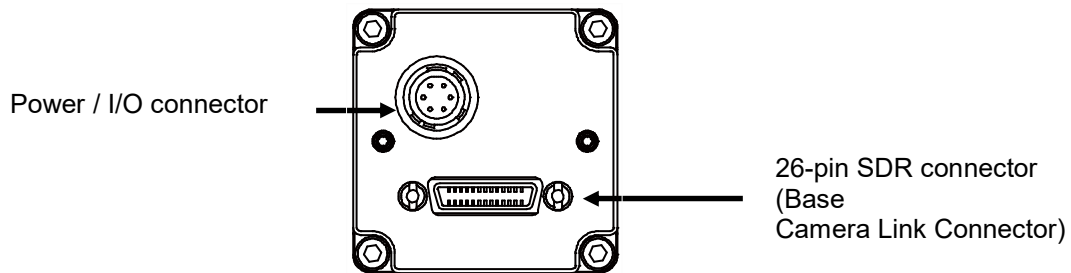

### 5.5.1 Camera Link connector SDR (3M) or equivalent connector x 1

This camera is PoCL supported Camera Link camera.  
The Camera Link frame grabber board is supplied the power to the camera through the Camera Link cable if the frame grabber board and the cable are applicable for the PoCL.

Please supply the power (+12 Vdc) from the power / I/O connector if the frame grabber board is not applicable for the PoCL.

#### Camera Link connector pin assignment

##### Base Camera Link Connector

Pin No.	Signal Name	Pin No.	Signal Name
1	+12V	14	GND
2	X0-	15	X0+
3	X1-	16	X1+
4	X2-	17	X2+
5	Xclk-	18	Xclk+
6	X3-	19	X3+
7	SerTC+	20	SerTC-
8	SerTFG-	21	SerTFG+
9	CC1- (TRG)	22	CC1+ (TRG)
10	CC2+	23	CC2-
11	CC3-	24	CC3+
12	CC4+	25	CC4-
13	GND	26	+12V

**Aegis** (888)687-6877  
ELECTRONIC GROUP, INC  
aegis-g2@aegiselect.com

### 5.5.2 Power / I/O connector

HR10A-7R-6PB (Hirose) or equivalent connector x 1

This connector is for DC12V power input and the input and output signals.  
Please use HR10A-7P-6S (Hirose) or equivalent connector for the connecting cable.

#### Power / I/O connector pin assignment

Pin No.	Signal Name	IN / OUT	Voltage		Consumption
			Low voltage	High voltage	
1	GND	IN	0 V		
2	Trigger	IN	0 to +0.99 V	+2.3 to +3.6V	5 $\mu$ A (typ.) (*1)
	FVAL	OUT	0 V	+3.3 V	10 mA (Max.) (*2)
3	LVAL	OUT	0 V	+3.3 V	10 mA (Max.) (*2)
4	Exposure	OUT	0 V	+3.3 V	10 mA (Max.) (*2)
5	Trigger Filter	OUT	0 V	+3.3 V	10 mA (Max.) (*2)
6	12 Vdc	IN	+12 V		

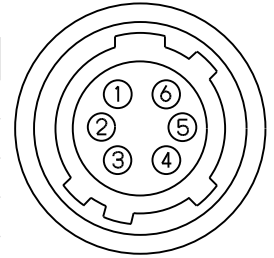

The trigger signal input connector is selectable from below two connectors by the camera control command (12H).

Camera Link connector: CC1

Power / I/O connector: Pin No. 2

When selecting "Pin No.2" for trigger input connector, input and output signals are below:

No.2: Trigger signal input, No.3: LVAL signal out, No.4: Exposure signal out (active low)

When not selecting "Pin No.2" for trigger input connector, input and output signals are below:

No.2: FVAL signal out, No.3: LVAL signal out, No.4: Exposure signal out (active low)

(\*1) The power consumption when the high voltage trigger signal input to the input port.

(\*2) The power consumption for the output port has to be managed less than 10 mA.

 (888)687-6877

ELECTRONIC GROUP, INC  
aegis-g2@aegiselect.com

### 5.5.3 Input signal circuit

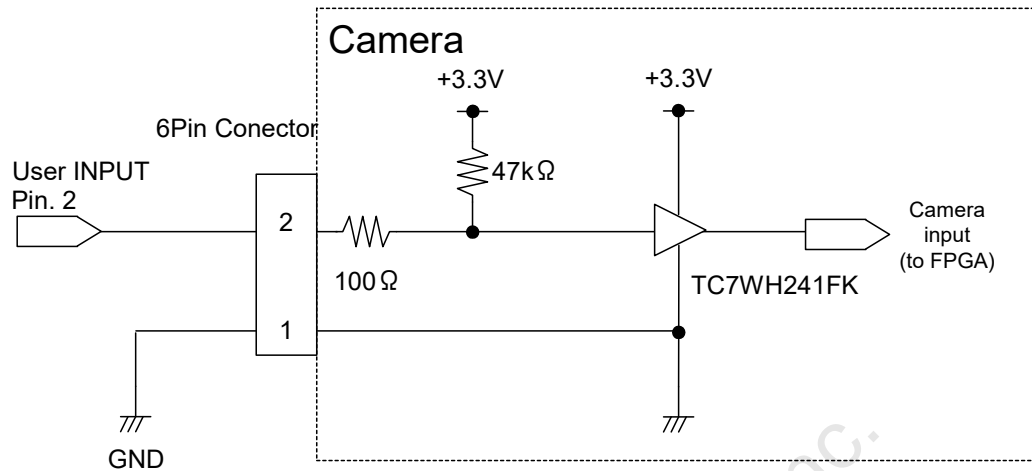

### 5.5.4 Output signal circuit

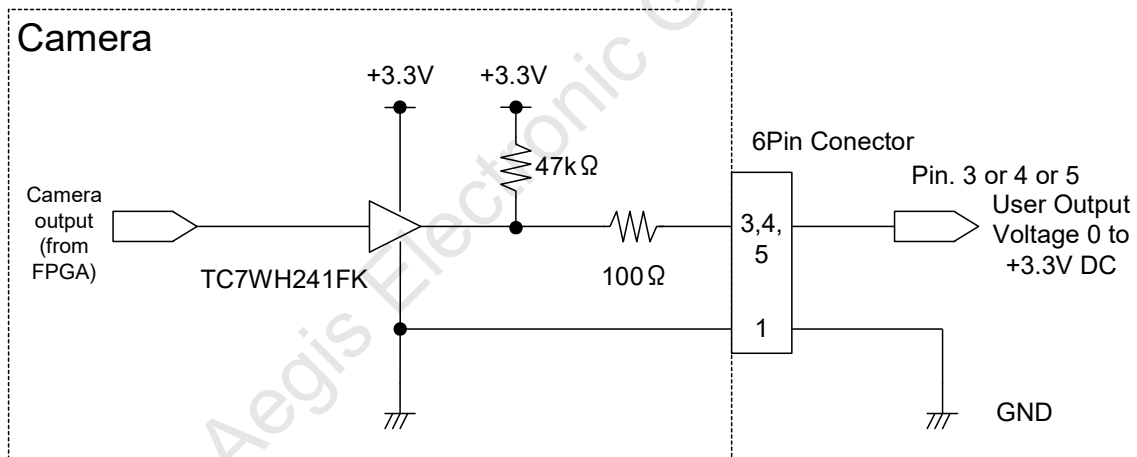

**Aegis** (888)687-6877  
 ELECTRONIC GROUP, INC  
 aegis-g2@aegiselect.com

## 6 Dimensions

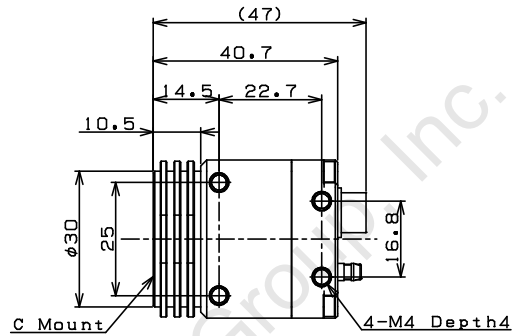
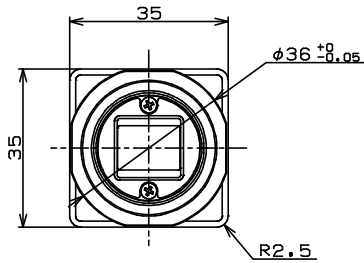
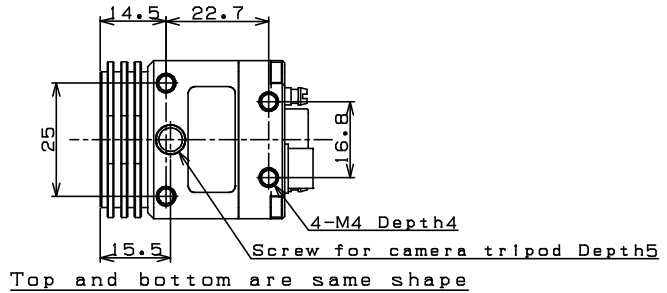
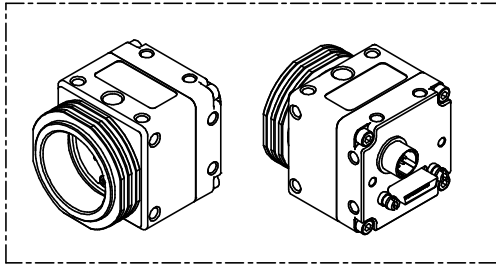

Left and right are same shape

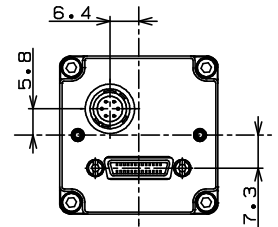

Unit: mm

Aegis Electronic Group, Inc.

**(888)687-6877**  
**ELECTRONIC GROUP, INC**  
**aegis-g2@aegiselect.com**

## 7 Sensor Information

### STC-SPB500PCL (Monochrome model)

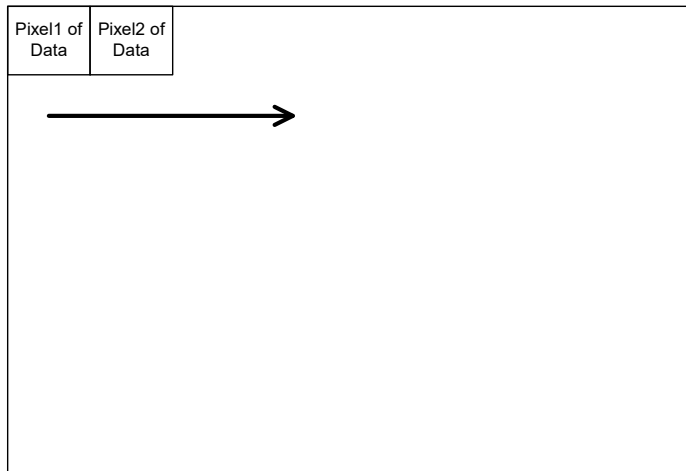

Pixel (n) of Data: nth pixel being transferred

### STC-SPC500PCL (Color model)

The Bayer pattern array on the sensor

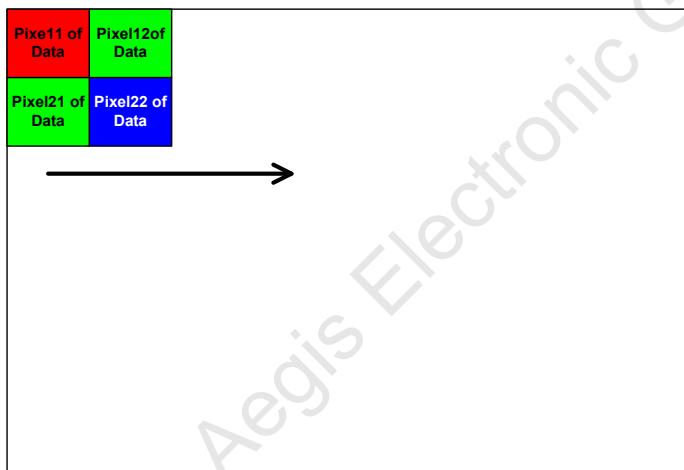

Pixel (m, n) of Data: nth pixel of the mth line being transferred

**(888)687-6877**  
**ELECTRONIC GROUP, INC**  
**aegis-g2@aegiselect.com**

## 8 Camera Output Timing Charts

### 8.1 Horizontal timing: Full scanning, binning operation

#### 8.1.1 2TAP (1X2-1Y) / Horizontal: 2,448 pixels

1CLK = 11.785 nseconds

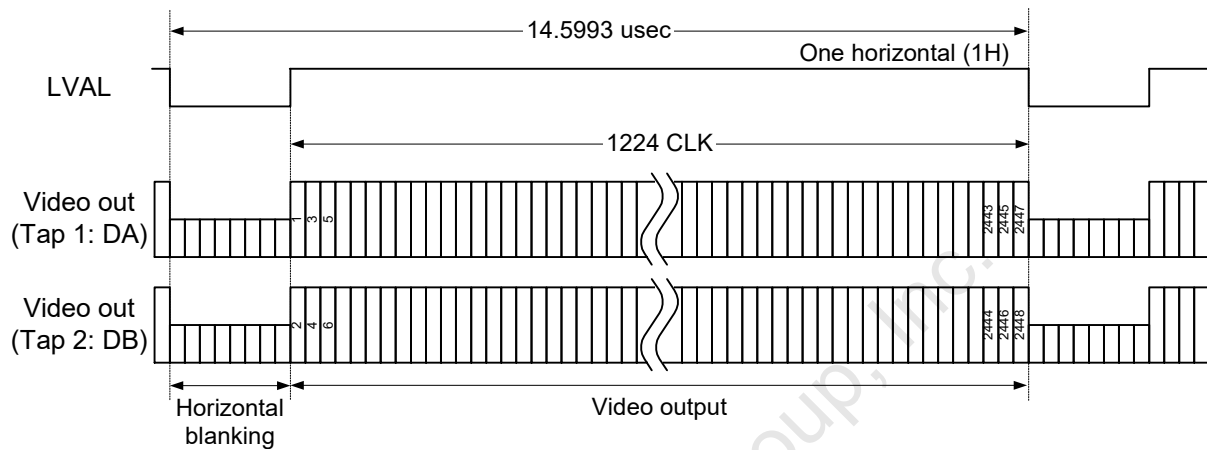

#### 8.1.2 3TAP (1X3-1Y) / Horizontal: 2,448pixels

1CLK = 15.15 nseconds

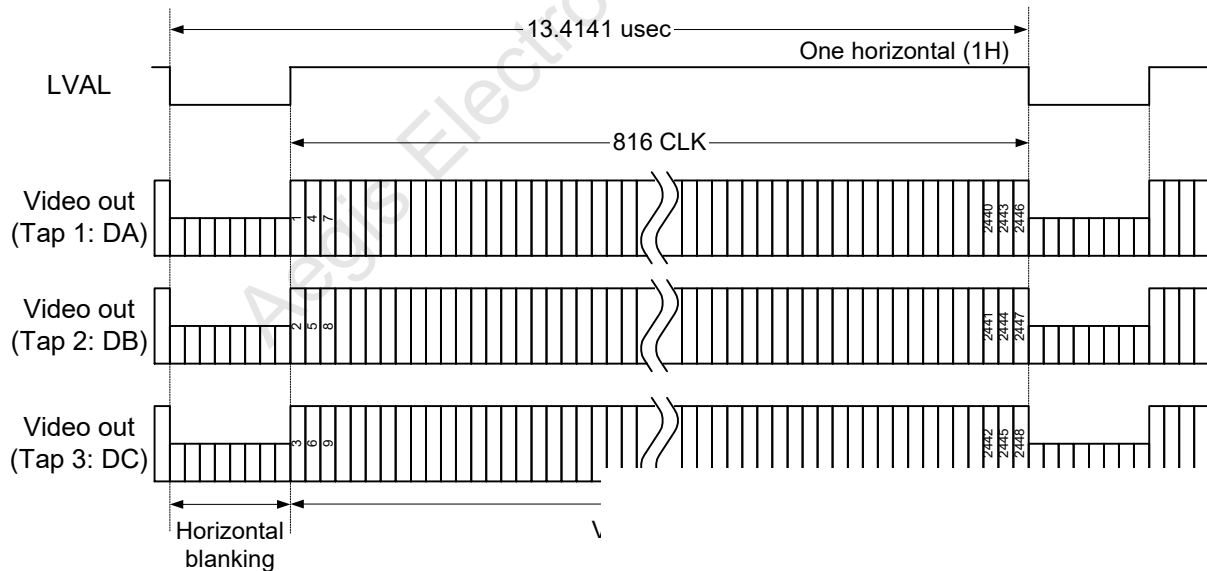

**Aegis** (888)687-6877  
 ELECTRONIC GROUP, INC  
 aegis-g2@aegiselect.com

## 8.2 Horizontal timings: Decimation operation

### 8.2.1 2TAP (1X2-1Y)

1CLK = 11.785 nseconds

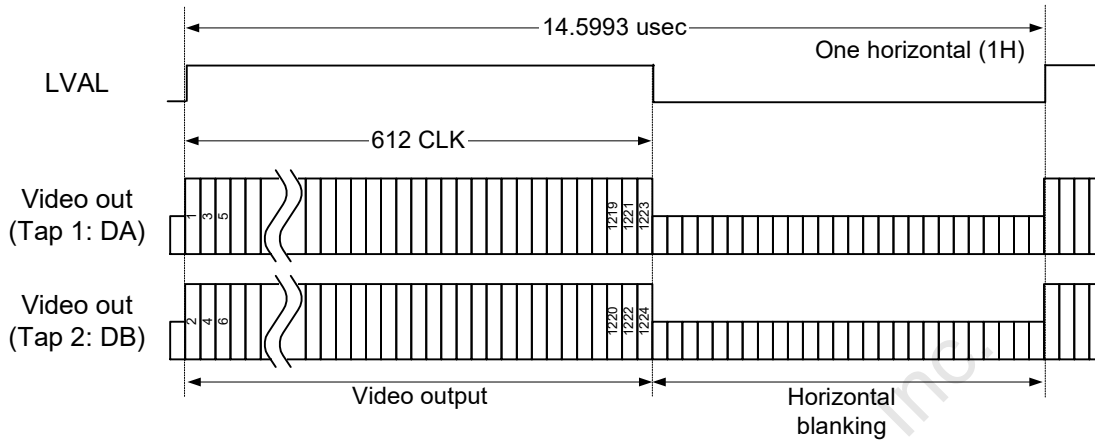

### 8.2.2 3TAP (1X3-1Y)

1CLK = 15.15 nseconds

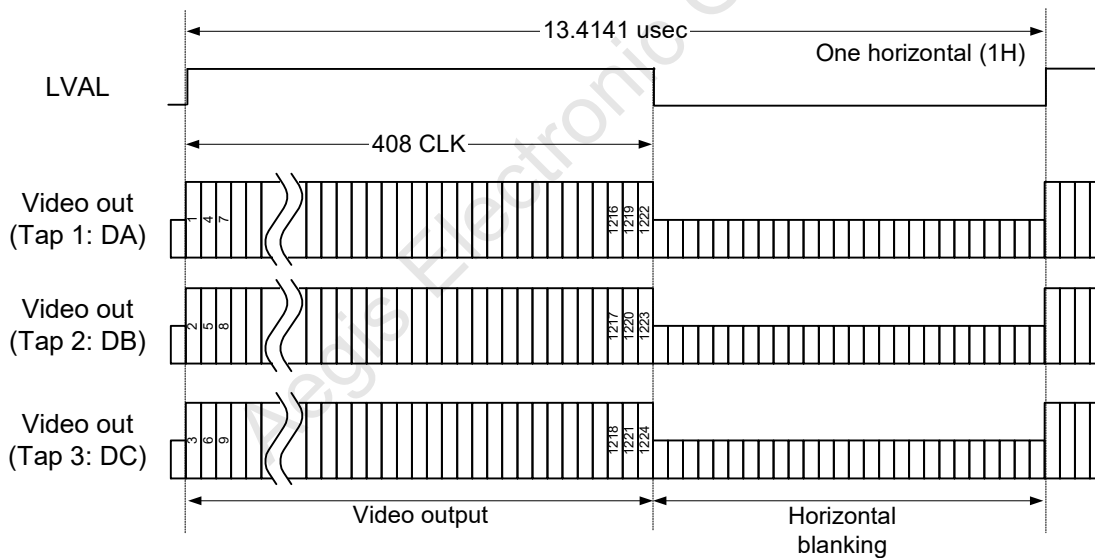

**Aegis** (888)687-6877  
 ELECTRONIC GROUP, INC  
 aegis-g2@aegiselect.com

### 8.3 Vertical timings

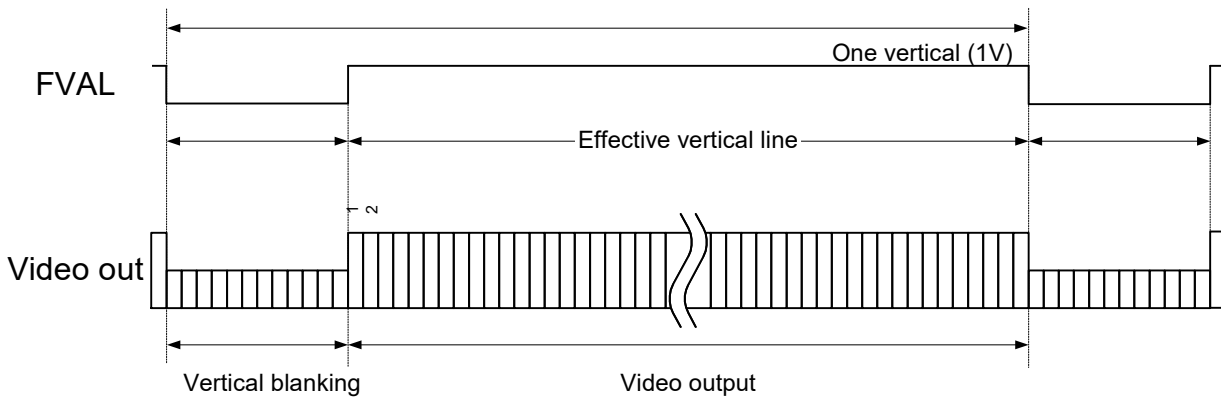

The table of the vertical effective lines and vertical blanking (Free-run / continuous operation)

Camera Link output TAP number	Full scanning			Binning		
	Vertical blanking (H)	Vertical effective lines (H)	Frame rate (fps)	Vertical blanking (H)	Vertical effective lines (H)	Frame rate (fps)
3	46	2,048	35.60	46	1,024	69.67
2			32.71			64.01

Aegis Electronic Group, Inc.

**(888)687-6877**  
**ELECTRONIC GROUP, INC**  
**aegis-g2@aegiselect.com**

## 9 Scanning Modes

### 9.1 ROI output timing

The size and position for ROI region (one region) are adjustable.  
Please refer ROI setting parameters in below drawing.

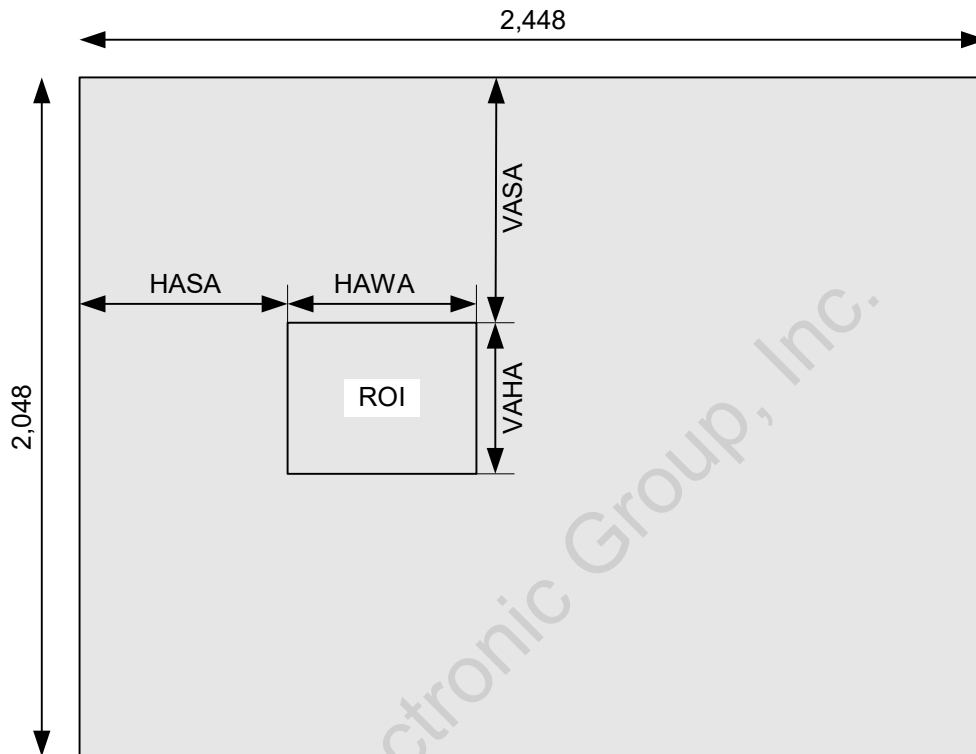

#### The frame rate on ROI

The maximum frame rate can be increase by adjusting the vertical effective lines for ROI.

The frame rate calculation formula is as following:

$$\text{Frame rate} = \text{Horizontal frequency} / (\text{Vertical effective lines} + \text{Vertical blanking})$$

The horizontal effective pixels for ROI do not make any influence for the maximum frame rate.  
Please refer "The image data transferring speed" for the details of the horizontal frequency.

 (888)687-6877  
ELECTRONIC GROUP, INC  
aegis-g2@aegiselect.com

### 9.2 Decimation

The horizontal and vertical thinning image is output.

By using decimation function, half resolution (2x2 sub-sampling) without change the view angle, and twice faster frame rate image can be obtained.

- \* Decimation function cannot use with the binning function.
- \* Decimation function cannot use with the ROI function.

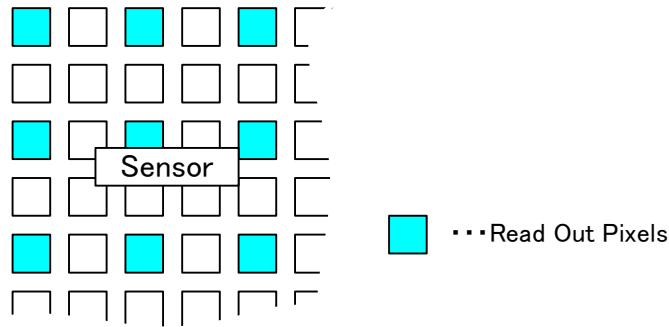

### 9.3 Binning

The brightness of two vertical pixels are summing into one pixel. (No horizontal brightness summing)

By using binning function, twice brighter, half resolution and twice faster frame rate image can be obtained.

- \* Binning function cannot use with the decimation function.
- \* Binning function can use with the ROI function.

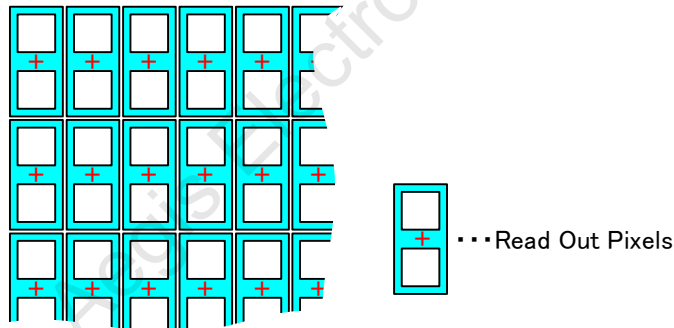

**(888)687-6877**  
**ELECTRONIC GROUP, INC**  
**aegis-g2@aegiselect.com**

## 10 Image Data Transferring Speed

### 10.1 Extend horizontal cycle

The horizontal cycle of the image can extend with the camera control command.  
 The frame rate is changed when the horizontal cycle of the image is extended.  
 The Camera Link clock speed is selectable from 84.857 MHz, 66 MHz or 33 MHz.

Please select the optimum Camera Link clock speed if the long length Camera Link cable is required.

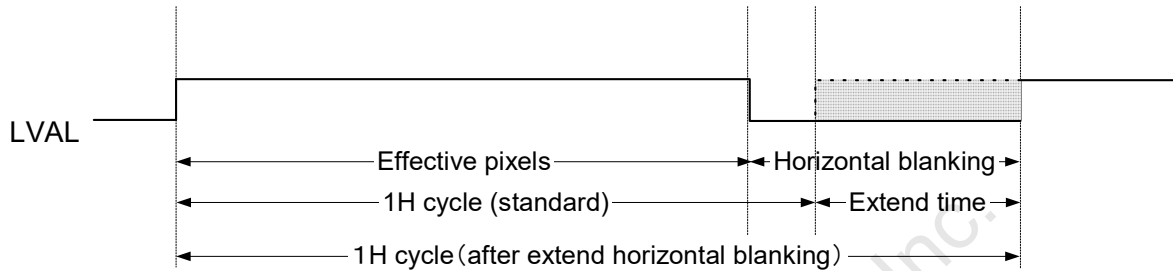

The calculate formula for extend time:  
 Extend time = EXT\_HB [11:0] \* 13.468 nsec.  
 \* EXT\_B: Data of 77H and 76H

The table of the Camera Link clock speed and the camera operation

Camera settings		Camera operation		
Register [EEH]	EXT_HB[11:0] Register [77H,76H]	Camera Link Clock speed (MHz)	Horizontal frequency (KHz)	Frame rate (fps)
3	0	66	74.55	35.60
	849	33	40.24	19.21
2	0	84.857	68.50	32.71
	298	66	53.73	25.65
	1,680	33	26.86	12.82

### 10.2 Change transferring clock

The Camera Link clock speed is selectable from 84.857 MHz, 66 MHz or 39.6 MHz.  
 (This function is available if serial number of camera is 18Exxxx or later. Please use extending horizontal cycle to reduce transferring clock)

Please select the optimum Camera Link clock speed if the long length Camera Link cable is required

The table of the Camera Link clock speed and the

Camera settings		Ca Clock
Register [EEH]	Register [11H[D6~D5]]	
3	00 / 01	
	10 / 11	
2	00	
	01	
	10 / 11	

**Aegis** (888)687-6877  
 ELECTRONIC GROUP, INC  
 aegis-g2@aegiselect.com

## 11 Camera Function Modes

### 11.1 Free-run / Continuous mode

This mode can be outputted camera video signal continuously.

#### 11.1.1 Full frame exposure

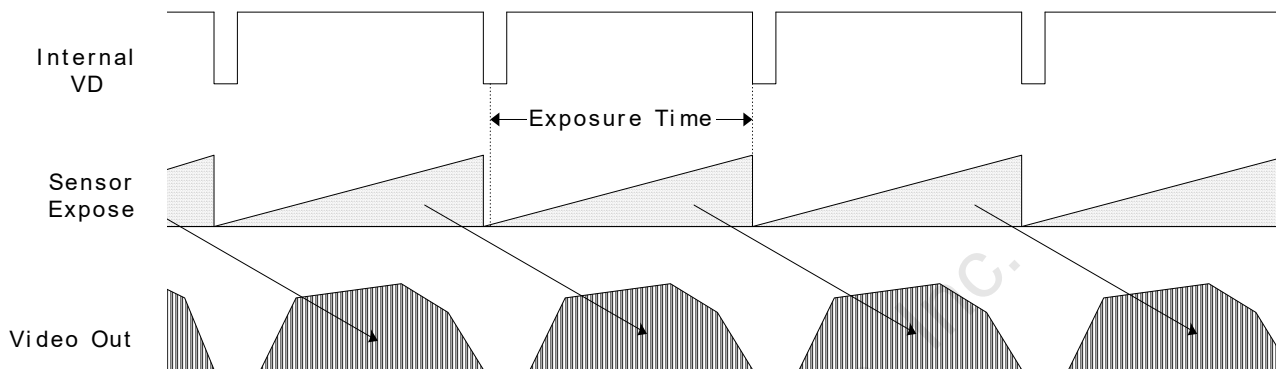

#### 11.1.2 Electronic shutter

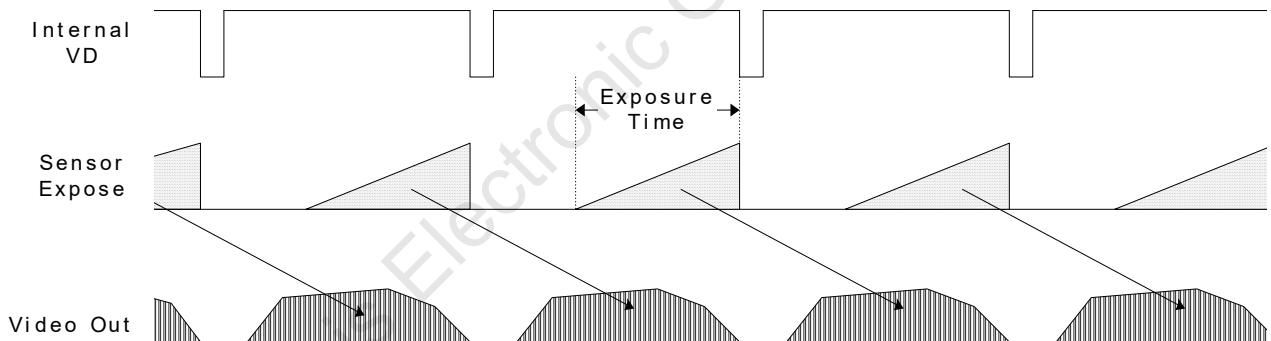

**(888)687-6877**  
 ELECTRONIC GROUP, INC  
[aegis-g2@aegiselect.com](mailto:aegis-g2@aegiselect.com)

### 11.2 Pulse width trigger mode

The camera exposure starts by the trigger signal.

In this trigger mode with positive trigger polarity, the camera exposure starts at the rising edge of the trigger signal and stops at the falling edge of the trigger signal.

Therefore, In the case of the exposure positive polarity is selected, the exposure periods (exposure time) are the high states of the trigger signal.

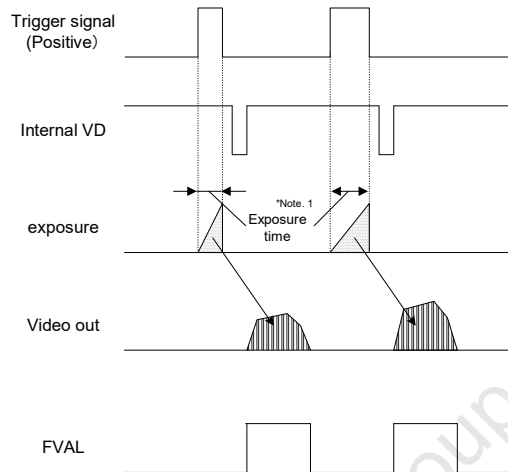

Note.1: The exposure time sets by the active pulse width of the trigger signal.  
No FVAL output without any trigger signal.

### 11.3 Edge Preset Trigger mode

The camera exposure starts by the trigger signal.

In this trigger mode with positive trigger polarity, the camera exposure starts at the rising edge of the trigger signal. The exposure time is preset by the "Electrical Shutter" settings.

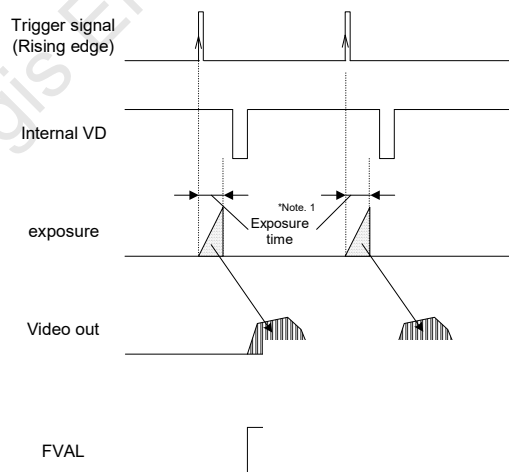

Note.1: The exposure time sets by the preset ele

**Aegis** (888)687-6877  
ELECTRONIC GROUP, INC  
aegis-g2@aegiselect.com

## 11.4 Exposure Timing Details

### 11.4.1 Fast trigger mode

The camera exposure starts immediately after the valid edge of the trigger signal is detected.

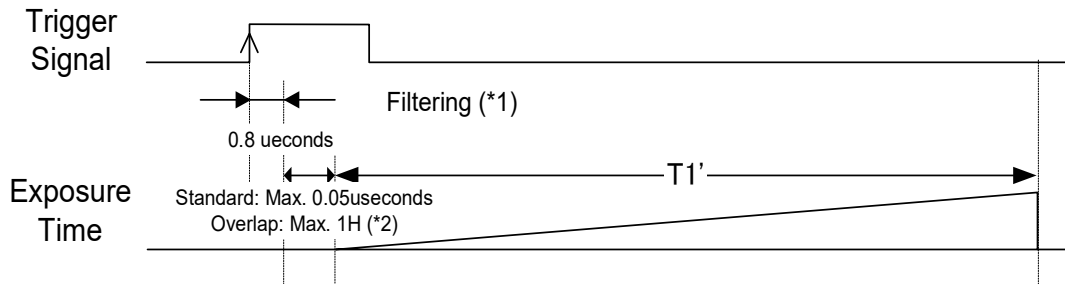

Exposure time: Pulse width trigger:  $T1' = \text{Active pulse width of the trigger signal} + \text{Toffset}$   
(Toffset = 13.73us.)

Edge preset trigger:  $T1' = \text{Preset exposure time}$

(\*1) The active pulse width for the trigger signal has to be longer than 0.8  $\mu$ seconds.  
If this is shorter than 0.8  $\mu$ seconds, the trigger signal is invalid.

(\*2) The overlap is the trigger signal input to the camera while the image is transferring.

### 11.4.2 Trigger overlap mode

The fast trigger mode is recommended to use.

Please use this overlap mode, if the one horizontal line has different level of the signal (similar of the horizontal line noise), is appeared in the image when the trigger signal inputs while the image data is transferring.

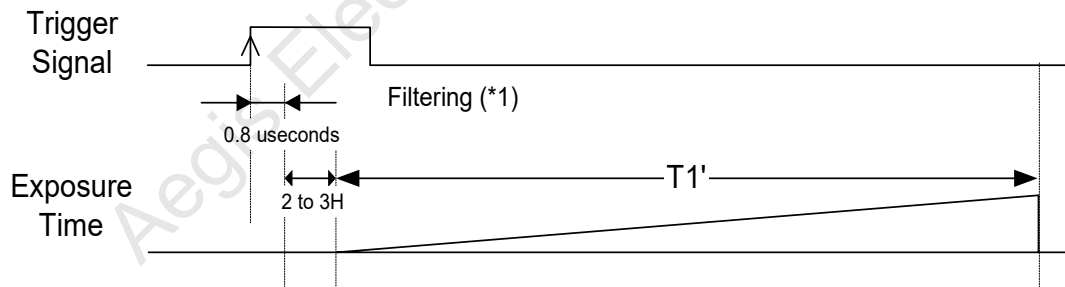

Exposure time: Pulse width trigger:  $T1' = \text{Active pulse width of the trigger signal} + \text{Toffset}$   
(Toffset = 13.73us.)

Edge preset trigger:  $T1' = \text{Preset exposure time}$

\* The actual exposure time u

(\*1) The active pulse width for the trigger sig  
If this is shorter than 0.8  $\mu$ seconds, the tr

**Aegis** (888)687-6877  
ELECTRONIC GROUP, INC  
aegis-g2@aegiselect.com



11.4.3 Exposure timing for each mode

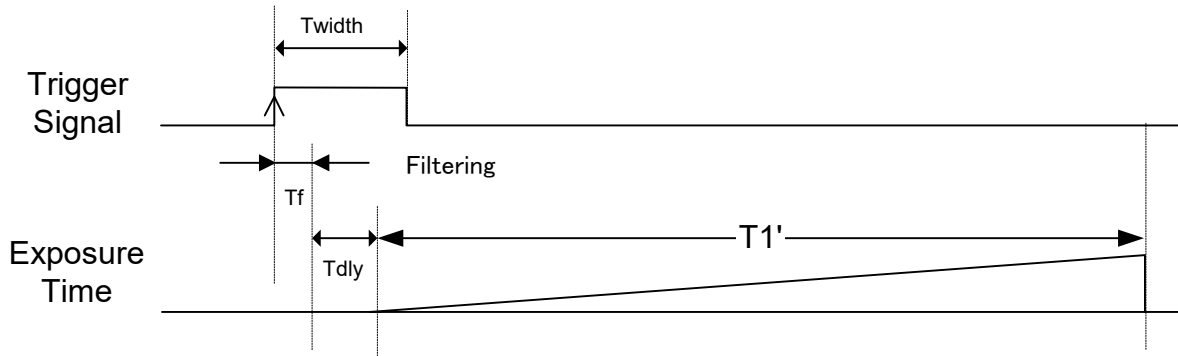

Toffset = 13.73 μseconds.

Exposure start mode	Trigger mode	(Tf)	Delay for the trigger signal input to start exposure (Tdly)		Adjustment unit for the exposure time	Exposure time (T1)	Minimum Exposure time (T1min)
			Without trigger overlap	With trigger overlap			
Fast trigger	Pulse width	0.8 μs.	No delay	No delay to 1H	40.4ns (24.75MHz)	Twidth + Toffset	Toffset
	Edge preset				1us	Preset exposure time	1us
Trigger Overlap	Pulse width	0.8 μs.	2 to 3H	2 to 3H	1H	Twidth + Toffset	1H + Toffset
	Edge preset					Preset exposure time	

Aegis Electronic Group, Inc.

**(888)687-6877**  
**ELECTRONIC GROUP, INC**  
**aegis-g2@aegiselect.com**

## 12 Camera Function

### 12.1 Lookup table (Gamma)

The camera has the brightness signal conversion function based on the input brightness level with the lookup table. This table has 32 steps (input signal (0 to 4,095) divided by 32). The output signal is converted for these 32 steps. The midpoint  $x$  that is between the 32 steps, is calculated automatically. Please refer B0H to CEH [The lookup table (Gamma)] in the camera control command for more details. Gamma Level can be set as 15 steps.

The output signal formula is as following:

$$\text{Output signal} = \text{Table value} * (\text{Gamma Level (0 to 15) [Address: 4FH]} / 15)$$

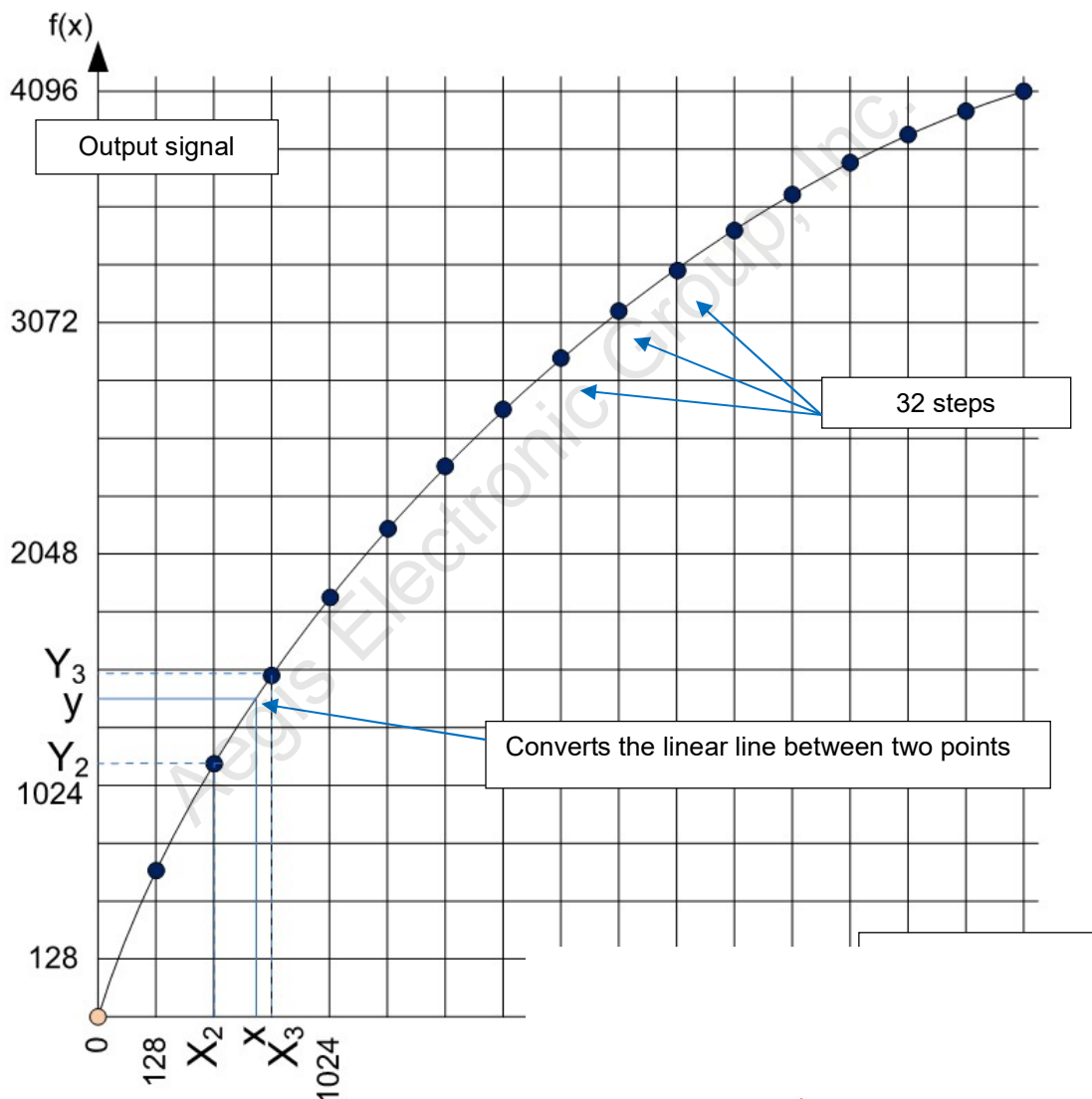

e.g.:  $X_2$ ,  $X_3$  are selected as the inputs from 32 steps.  
The output  $y$  will come from the converted point  $l$  and  $X_3$ .

**Aegis** (888)687-6877  
ELECTRONIC GROUP, INC  
aegis-g2@aegiselect.com

## 13 Communication Protocol specifications

This camera has a communication function that enables external devices such as a PC, to change the camera settings. Please use "CLCtrl2 (ver. 1.18 or later)" communication software or use the following communication protocol to communicate to the camera.

### 13.1 Communication method

UART (RS232C standard compliant), Binary communication

### 13.2 Communication settings

Baud rate	<b>9,600bps</b> / 38,400bps / 57,600bps / 115,200bps
Data bit	8bits
Parity	None
Stop bit	1bit
Flow control	None

Aegis Electronic Group, Inc.

 **(888)687-6877**  
 ELECTRONIC GROUP, INC  
**aegis-g2@aegiselect.com**

### 13.3 Communication format

A. The sending data format from the PC to the camera is as follows:

SOF (8bits)	Device code (6bits)	Read / write (1bit)	Page selection (1bit)	Command code (8bits)	Data length (8bits)	Data (Write: Data length ) (Read: 1byte)	EOF (8bits)
----------------	------------------------	------------------------	--------------------------	-------------------------	------------------------	--	----------------

B. The receiving data format from the camera is as follows:

a. After sent the read command

SOF (8bits)	Data length (8bits)	Data (Data length byte)	EOF (8bits)
----------------	------------------------	----------------------------	----------------

b. After sent the write command

SOF (8bits)	Data length (00H) (8bits)	Receiving code (8bits)	EOF (8bits)
----------------	------------------------------	---------------------------	----------------

C. Descriptions of the format

SOF	Start of the frame. Sets (or obtains) the value is as "02H" always.
Device code	Sets the device code of the camera. Sets the value is as "000000" always.
Read / Write	Sets "0" when sending read command. Sets "1" when sending write command.
Page selection	Sets "0" when accessing to the register of the camera. Obtains the current data from the register when sending read command. Replaces the data in the register by sending data when sending write command. <b>The data in the EEPROM does not replace.</b> Sets "1" when accessing to the EEPROM of the camera. Obtains the data from the EEPROM when sending read command. Replaces the data in the EEPROM by sending data when sending write command.  The camera uses the data in the EEPROM when the power on the camera. The camera sends the receiving code as "01H" to the PC after the data in the EEPROM is replaced. The camera rejects any commands while the data in the EEPROM is replacing. (Approximately 5 mseconds / byte)
Command code	Sets the command code. Please refer "The camera control commands" for more details.
Data length	Sets (or obtains) the data length. (unit: byte) For receiving data: The data length is based on the command after sent read command. The data length is "00H" after sent write command. For sending data: The data length is 1 byte when sending read command. The data length is based on the command when sending write command.
Data	Sets (or obtains) the data based on the command.
EOF	End of the frame Sets (or obtains) the value is as "03H" always.
Receiving code	Obtains the result of the sending command. 01H: The command proceeded correctly (ACK) 10H: The command could not process correctly (NAC) 11H: The communication issue

D. Command example

Send the read command to read the 00H address:

02, 00, 00, 01, 00, 03  
SOF, (Device code / Read / Register), Comr

The return command

02, 01, 00, 03

 (888)687-6877  
ELECTRONIC GROUP, INC  
aegis-g2@aegiselect.com

### 13.4 Camera control commands

#### 13.4.1 Camera control commands list

Note. 1: The data unit of each command is 1 byte (8bits).

Note. 2: The data can be saved to EEPROM if "X" in "EEPROM" column in the list.

Note. 3: The camera is operating with the data of EEPROM when power on camera.

Bank No.	Command No.	R/W	EEPROM	Function	Default Data	Data Range
00H	00 - 0EH			Reserved	-	-
	0FH	R/W	X	Bank number of control command (8bits: D[7..0])	00H	
	10H	R/W	X	Camera function mode 1 (8bits: D[7..0])	00H	
	11H	R/W	X	Camera function mode 2 (8bits: D[7..0])	00H	
	12H	R/W	X	Camera function mode 3 (8bits: D[7..0])	40H	
	13H			Reserved	-	-
	14H	R/W	X	Communication mode (8bits: D[7..0])	01H	
	15 - 1FH			Reserved	-	-
	20H	R/W	X	Exposure time of electronic shutter (24bits: D[7..0])	0	0 to 16,777,215
	21H	R/W	X	Exposure time of electronic shutter (24bits: D[15..8])		
	22H	R/W	X	Exposure time of electronic shutter (24bits: D[23..16])		
	23 - 27H			Reserved	-	-
	28H	R/W	X	Delay time for trigger signal (8bits: D[7..0])	0	0 to 255
	29 - 2FH			Reserved	-	-
	30H	R/W	X	Analog gain (8bits: D[7..0])	0	0 to 180
	31H	R/W	X	Digital gain (8bits: D[7..0])	Factory adjusted value	0 to 240
	32 - 37H			Reserved	-	-
	38H	R/W	X	Clamp level (8bits: D[7..0])	40	0 to 255
	39H			Reserved	-	-
	3AH	R/W	X	White Balance R gain (15bits: D[7..0]) (*1)	0	0 to 255
	3BH	R/W	X	White Balance B gain (15bits: D[7..0]) (*1)	0	0 to 255
	3CH	R/W	X	White Balance GR gain (15bits: D[7..0]) (*1)	0	0 to 255
	3DH	R/W	X	White Balance GB gain (15bits: D[7..0]) (*1)	0	0 to 255
3E - 4EH			Reserved	-	-	
4FH	R/W	X	Gamma level setting (4bits: D[3..0])	15	0 to 15	

(\*1) Only available for the color model

**(888)687-6877**  
**ELECTRONIC GROUP, INC**  
**aegis-g2@aegiselect.com**

Bank No.	Command No.	R/W	EEPROM	Function	Default Data	Data Range
00H	50 - 75H			Reserved	-	-
	76H	R/W	X	Horizontal cycle extend time (12bits: D[7..0])	0	0 to 4,095
	77H	R/W	X	Horizontal cycle extend time (12bits: D[11..8])		
	78H	R/W	X	Test Pattern (3bits: D[2..0])	0	0 to 7
	79 - 7FH			Reserved	-	-
	80H	R/W	X	EEPROM control (8bits: D[7..0])	0	
	81 - 8FH			Reserved	-	-
	90H	R/W	X	Vertical ROI_A Start line (16bits: D[7..0])	0	0 to 2,044
	91H	R/W	X	Vertical ROI_A Start line (16bits: D[15..8])		
	92 - 9FH			Reserved	-	-
	A0H	R/W	X	Vertical ROI_A Effective lines (16bits: D[7..0])	2,048	4 to 2,048
	A1H	R/W	X	Vertical ROI_A Effective lines (16bits: D[15..8])		
	A2 - AFH			Reserved	-	-
	B0H	R/W	X	Horizontal ROI_A Start pixel (16bits: D[7..0])	0	Color: 0 to 2,446 Monochrome: 0 to 2,447
	B1H	R/W	X	Horizontal ROI_A Start pixel (16bits: D[15..8])		
	B2 - BFH			Reserved	-	-
	C0H	R/W	X	Horizontal ROI_A Effective pixels (16bits: D[7..0])	2,448	2TAP: 2 to 2,448 3TAP: 3 to 2,448
	C1H	R/W	X	Horizontal ROI_A Effective pixels (16bits: D[15..8])		
	C2 - CFH			Reserved	-	-
	D0H	R/W	X	Pixel defect correction control (8bits: D[7..0])	0	
	D1H	R/W	X	Pixel defect correction coordinate number (8bits: D[7..0])	0	0 to 255
	D2H	R/W	X	Pixel defect X position (Set) (16bits: D[7..0])	0	0 to 2,448
	D3H	R/W	X	Pixel defect X position (Set) (16bits: D[15..8])		
	D4H	R/W	X	Pixel defect Y position (Set) (16bits: D[7..0])	0	0 to 2,048
	D5H	R/W	X	Pixel defect Y position (Set) (16bits: D[15..8])		
	D6H	R/W	X	Pixel defect X position (Read) (16bits: D[7..0])	0	-
	D7H	R/W	X	Pixel defect X position (Read) (16bits: D[15..8])		
	D8H	R/W	X	Pixel defect Y position (Read) (16bits: D[7..0])	0	-
	D9H	R/W	X	Pixel defect Y position (Read) (16bits: D[15..8])		
	DA - DDH			Reserved	-	-
	DEH	R/W	X	Pixel defect correc		
	DF - E9H			Reserved		
	EAH	R/W	X	White Balance R c		
	EBH	R/W	X	White Balance B c		
	ECH	R/W	X	White Balance GF		
	EDH	R/W	X	White Balance GB		
EEH	R/W	X	Camera function n			
EF - FFH			Reserved			

(\*1) Only available for the color model

 (888)687-6877  
ELECTRONIC GROUP, INC  
aegis-g2@aegiselect.com

Bank No.	Command No.	R/W	EEPROM	Function	Default Data	Data Range
01H	50H	R/W	X	Lookup table (Gamma) GSTEP0 (8bits: D[7..0])	36H	0 to FFH
	51H	R/W	X	Lookup table (Gamma) GSTEP1 (8bits: D[7..0])	4AH	0 to FFH
	52H	R/W	X	Lookup table (Gamma) GSTEP2 (8bits: D[7..0])	58H	0 to FFH
	53H	R/W	X	Lookup table (Gamma) GSTEP3 (8bits: D[7..0])	64H	0 to FFH
	54H	R/W	X	Lookup table (Gamma) GSTEP4 (8bits: D[7..0])	6FH	0 to FFH
	55H	R/W	X	Lookup table (Gamma) GSTEP5 (8bits: D[7..0])	79H	0 to FFH
	56H	R/W	X	Lookup table (Gamma) GSTEP6 (8bits: D[7..0])	81H	0 to FFH
	57H	R/W	X	Lookup table (Gamma) GSTEP7 (8bits: D[7..0])	89H	0 to FFH
	58H	R/W	X	Lookup table (Gamma) GSTEP8 (8bits: D[7..0])	91H	0 to FFH
	59H	R/W	X	Lookup table (Gamma) GSTEP9 (8bits: D[7..0])	98H	0 to FFH
	5AH	R/W	X	Lookup table (Gamma) GSTEP10 (8bits: D[7..0])	9EH	0 to FFH
	5BH	R/W	X	Lookup table (Gamma) GSTEP11 (8bits: D[7..0])	A5H	0 to FFH
	5CH	R/W	X	Lookup table (Gamma) GSTEP12 (8bits: D[7..0])	ABH	0 to FFH
	5DH	R/W	X	Lookup table (Gamma) GSTEP13 (8bits: D[7..0])	B0H	0 to FFH
	5EH	R/W	X	Lookup table (Gamma) GSTEP14 (8bits: D[7..0])	B6H	0 to FFH
	5FH	R/W	X	Lookup table (Gamma) GSTEP15 (8bits: D[7..0])	BBH	0 to FFH
	60H	R/W	X	Lookup table (Gamma) GSTEP16 (8bits: D[7..0])	C1H	0 to FFH
	61H	R/W	X	Lookup table (Gamma) GSTEP17 (8bits: D[7..0])	C6H	0 to FFH
	62H	R/W	X	Lookup table (Gamma) GSTEP18 (8bits: D[7..0])	CAH	0 to FFH
	63H	R/W	X	Lookup table (Gamma) GSTEP19 (8bits: D[7..0])	CFH	0 to FFH
	64H	R/W	X	Lookup table (Gamma) GSTEP20 (8bits: D[7..0])	D4H	0 to FFH
	65H	R/W	X	Lookup table (Gamma) GSTEP21 (8bits: D[7..0])	D8H	0 to FFH
	66H	R/W	X	Lookup table (Gamma) GSTEP22 (8bits: D[7..0])	DDH	0 to FFH
	67H	R/W	X	Lookup table (Gamma) GSTEP23 (8bits: D[7..0])	E1H	0 to FFH
	68H	R/W	X	Lookup table (Gamma) GSTEP24 (8bits: D[7..0])	E5H	0 to FFH
	69H	R/W	X	Lookup table (Gamma) GSTEP25 (8bits: D[7..0])	E9H	0 to FFH
	6AH	R/W	X	Lookup table (Gamma) GSTEP26 (8bits: D[7..0])	EDH	0 to FFH
	6BH	R/W	X	Lookup table (Gamma) GSTEP27 (8bits: D[7..0])	F1H	0 to FFH
	6CH	R/W	X	Lookup table (Gamma) GSTEP28 (8bits: D[7..0])	F5H	0 to FFH
	6DH	R/W	X	Lookup table (Gamma) GSTEP29 (8bits: D[7..0])	F9H	0 to FFH
	6EH	R/W	X	Lookup table (Gamma) GSTEP30 (8bits: D[7..0])	FCH	0 to FFH
	6FH	R/W	X	Lookup table (Gamma) GSTEP31 (8bits: D[7..0])	FFH	0 to FFH

**(888)687-6877**  
**ELECTRONIC GROUP, INC**  
**aegis-g2@aegiselect.com**

### 13.4.2 Description of the camera control commands (Bank No.: 00H)

The underline settings are the factory default settings.

Command No.	Command Description																																				
0FH: [7..0]	<p>[Bank number of control command] Default data: 00H Selects the bank number of control command.</p> <table border="1"> <tr> <td>D7</td><td>D6</td><td>D5</td><td>D4</td><td>D3</td><td>D2</td><td>D1</td><td>D0</td> </tr> </table> <table border="1"> <tr> <td>D7 to D1</td> <td>No Function</td> <td colspan="2"><u>Always set as "0000000"</u></td> </tr> <tr> <td>D0</td> <td>Bank number</td> <td>0: 00H Bank</td> <td>1: 01H Bank</td> </tr> </table>	D7	D6	D5	D4	D3	D2	D1	D0	D7 to D1	No Function	<u>Always set as "0000000"</u>		D0	Bank number	0: 00H Bank	1: 01H Bank																				
D7	D6	D5	D4	D3	D2	D1	D0																														
D7 to D1	No Function	<u>Always set as "0000000"</u>																																			
D0	Bank number	0: 00H Bank	1: 01H Bank																																		
10H: MOD1 [7..0]	<p>[Camera function mode 1] Default data: MOD1 [7..0] = 00H Sets the camera function mode.</p> <table border="1"> <tr> <td>D7</td><td>D6</td><td>D5</td><td>D4</td><td>D3</td><td>D2</td><td>D1</td><td>D0</td> </tr> </table> <table border="1"> <tr> <td>D7</td> <td>No Function</td> <td colspan="2"><u>Always set as "0"</u></td> </tr> <tr> <td>D6</td> <td>Trigger Polarity</td> <td>0: Positive</td> <td>1: Negative</td> </tr> <tr> <td>D5</td> <td>Trigger Mode</td> <td>0: <u>Edge Preset</u></td> <td>1: Pulse Width</td> </tr> <tr> <td>D4</td> <td>Binning Mode *1</td> <td>0: Off</td> <td>1: On</td> </tr> <tr> <td>D3</td> <td>Scanning Mode *1</td> <td>0: <u>Full Scanning</u></td> <td>1: Decimation</td> </tr> <tr> <td>D2 to D0</td> <td>No Function</td> <td colspan="2"><u>Always set as "000"</u></td> </tr> </table> <p>*1 Only available for the monochrome model (Please set as "0" for the color model)</p>	D7	D6	D5	D4	D3	D2	D1	D0	D7	No Function	<u>Always set as "0"</u>		D6	Trigger Polarity	0: Positive	1: Negative	D5	Trigger Mode	0: <u>Edge Preset</u>	1: Pulse Width	D4	Binning Mode *1	0: Off	1: On	D3	Scanning Mode *1	0: <u>Full Scanning</u>	1: Decimation	D2 to D0	No Function	<u>Always set as "000"</u>					
D7	D6	D5	D4	D3	D2	D1	D0																														
D7	No Function	<u>Always set as "0"</u>																																			
D6	Trigger Polarity	0: Positive	1: Negative																																		
D5	Trigger Mode	0: <u>Edge Preset</u>	1: Pulse Width																																		
D4	Binning Mode *1	0: Off	1: On																																		
D3	Scanning Mode *1	0: <u>Full Scanning</u>	1: Decimation																																		
D2 to D0	No Function	<u>Always set as "000"</u>																																			
11H: MOD2 [7..0]	<p>[Camera function mode 2] Default data: MOD2 [7..0] = 00H Sets the camera function mode.</p> <table border="1"> <tr> <td>D7</td><td>D6</td><td>D5</td><td>D4</td><td>D3</td><td>D2</td><td>D1</td><td>D0</td> </tr> </table> <table border="1"> <tr> <td>D7 to D4</td> <td>No Function</td> <td colspan="2"><u>Always set as "0"</u></td> </tr> <tr> <td>D6 to D5</td> <td>Clock Speed</td> <td>00: 84.857 MHz 10: 39.6 MHz</td> <td>01: 66 MHz 11: 39.6 MHz</td> </tr> <tr> <td>D4</td> <td>No Function</td> <td colspan="2"><u>Always set as "0"</u></td> </tr> <tr> <td>D3</td> <td>Operation Mode</td> <td>0: <u>Trigger</u></td> <td>1: Free-run / Continuous</td> </tr> <tr> <td>D2 to D0</td> <td>No Function</td> <td colspan="2"><u>Always set as "000"</u></td> </tr> </table> <p>* Note: While the camera is in trigger mode, the image will not output without the trigger signal input.</p>	D7	D6	D5	D4	D3	D2	D1	D0	D7 to D4	No Function	<u>Always set as "0"</u>		D6 to D5	Clock Speed	00: 84.857 MHz 10: 39.6 MHz	01: 66 MHz 11: 39.6 MHz	D4	No Function	<u>Always set as "0"</u>		D3	Operation Mode	0: <u>Trigger</u>	1: Free-run / Continuous	D2 to D0	No Function	<u>Always set as "000"</u>									
D7	D6	D5	D4	D3	D2	D1	D0																														
D7 to D4	No Function	<u>Always set as "0"</u>																																			
D6 to D5	Clock Speed	00: 84.857 MHz 10: 39.6 MHz	01: 66 MHz 11: 39.6 MHz																																		
D4	No Function	<u>Always set as "0"</u>																																			
D3	Operation Mode	0: <u>Trigger</u>	1: Free-run / Continuous																																		
D2 to D0	No Function	<u>Always set as "000"</u>																																			
12H: MOD3 [7..0]	<p>[Camera function mode 3] Default data: MOD3 [7..0] = 40H Sets the camera function mode.</p> <table border="1"> <tr> <td>D7</td><td>D6</td><td>D5</td><td>D4</td><td>D3</td><td>D2</td><td>D1</td><td>D0</td> </tr> </table> <table border="1"> <tr> <td>D7 to D6</td> <td>Output Format</td> <td>00: 10bits 10: 12bits</td> <td>01: 8bits 11: No Function</td> </tr> <tr> <td>D5</td> <td>Trigger Input Selection</td> <td>0: CC1 on Camera Link</td> <td>1: 2pin on power / I/O</td> </tr> <tr> <td>D4</td> <td>Exposure Start Mode</td> <td>0: <u>Fast Trigger</u></td> <td>1: Trigger Overlap</td> </tr> <tr> <td>D3</td> <td>No Function</td> <td colspan="2"><u>Always set as "0"</u></td> </tr> <tr> <td>D2</td> <td>Vertical Image Flip</td> <td>0: Off</td> <td>1: Vertical Flip</td> </tr> <tr> <td>D1</td> <td>Horizontal Image Flip</td> <td>0: Off</td> <td>1: Horizontal Flip</td> </tr> <tr> <td>D0</td> <td>Gamma Mode</td> <td colspan="2"></td> </tr> </table> <p>* Note: Please refer "The details of the e</p>	D7	D6	D5	D4	D3	D2	D1	D0	D7 to D6	Output Format	00: 10bits 10: 12bits	01: 8bits 11: No Function	D5	Trigger Input Selection	0: CC1 on Camera Link	1: 2pin on power / I/O	D4	Exposure Start Mode	0: <u>Fast Trigger</u>	1: Trigger Overlap	D3	No Function	<u>Always set as "0"</u>		D2	Vertical Image Flip	0: Off	1: Vertical Flip	D1	Horizontal Image Flip	0: Off	1: Horizontal Flip	D0	Gamma Mode		
D7	D6	D5	D4	D3	D2	D1	D0																														
D7 to D6	Output Format	00: 10bits 10: 12bits	01: 8bits 11: No Function																																		
D5	Trigger Input Selection	0: CC1 on Camera Link	1: 2pin on power / I/O																																		
D4	Exposure Start Mode	0: <u>Fast Trigger</u>	1: Trigger Overlap																																		
D3	No Function	<u>Always set as "0"</u>																																			
D2	Vertical Image Flip	0: Off	1: Vertical Flip																																		
D1	Horizontal Image Flip	0: Off	1: Horizontal Flip																																		
D0	Gamma Mode																																				
14H: UART [7..0]	<p>[Communication mode] Default data: UA Sets the communication mode.</p> <table border="1"> <tr> <td>D7</td><td>D6</td><td>D5</td><td>D4</td><td>D3</td><td>D2</td><td>D1</td><td>D0</td> </tr> </table> <table border="1"> <tr> <td>D7 to D2</td> <td>No Function</td> </tr> <tr> <td>D1 to D0</td> <td>Communication Mode</td> </tr> </table>	D7	D6	D5	D4	D3	D2	D1	D0	D7 to D2	No Function	D1 to D0	Communication Mode																								
D7	D6	D5	D4	D3	D2	D1	D0																														
D7 to D2	No Function																																				
D1 to D0	Communication Mode																																				



Command No.	Command Description																																
20H: SVR [7:0] 21H: SVR [15:8] 22H: SVR [23:16]	[Exposure time of electronic shutter] Default data: SVR [23..0] = 0, Data range: 0 to 16,777,215 Sets the preset shutter speed (exposure time) for electronic shutter. Exposure time (shutter speed) = 1 * SVR (μseconds)																																
28H: DLY [7:0]	[Delay time for trigger signal] Default data: DLY [7..0] = 0, data range: 0 to 255 Sets the delay time from the trigger signal input to start exposure. Delay time = 2 * DLY [7..0] (μseconds)																																
30H: A_GAIN [7:0] 31H: D_GAIN [7:0]	[Analog gain / Digital gain] Default data: A_GAIN [7:0] = 0, D_GAIN [7:0] = The factory adjusted value, Data range: GAIN_A: 0 to 180, D_GAIN: 0 to 240 Sets the analog gain and digital gain. TOTAL_GAIN = (A_GAIN + D_GAIN + OFFSET_GAIN) / 10 [dB]																																
38H: CLAMP [7:0]	[Clamp level] Default data: CLAMP [7..0] = 40, Data range: 0 to 255 Sets the 10bits clamp level of the black signal.																																
3AH: WBR [7:0]	[White Balance R gain] Default data: WBR [14..0] = 4,096, Data range (WBR [7..0]): 0 to 255 Sets the Red gain on Bayer Video level = (Input video level - CLAMP [7..0]) * WBR [14..0] / 4,096 + CLAMP [7..0] WBR [14..0] = 4,096: x1 gain, WBR [14..0] = 8,192: x2 gain, WBR [14..0] = 12,288: x3 gain, WBR [14..0] = 16,384: x4 gain, WBR [14..0] = 20,480: x5 gain, WBR [14..0] = 24,576: x6 gain, WBR [14..0] = 28,672: x7 gain, WBR [14..0] = 32,768: x8 gain *WBR [14..8]: EAH																																
3BH: WBB [7:0]	[White Balance B gain] Default data: WBB [14..0] = 4,096, Data range (WBB [7..0]): 0 to 255 Sets the Blue gain on Bayer Video level = (Input video level - CLAMP [7..0]) * WBB [14..0] / 4,096 + CLAMP [7..0] WBB [14..0] = 4,096: x1 gain, WBB [14..0] = 8,192: x2 gain, WBB [14..0] = 12,288: x3 gain, WBB [14..0] = 16,384: x4 gain, WBB [14..0] = 20,480: x5 gain, WBB [14..0] = 24,576: x6 gain, WBB [14..0] = 28,672: x7 gain, WBB [14..0] = 32,768: x8 gain *WBB [14..8]: EBH																																
3CH: WBGR [7:0]	[White Balance GR gain] Default data: WBGR [14..0] = 4,096, Data range (WBGR [7..0]): 0 to 255 Sets the Green gain on Bayer GR line Video level = (Input video level - CLAMP [7..0]) * WBGR [14..0] / 4,096 + CLAMP [7..0] WBGR [14..0] = 4,096: x1 gain, WBGR [14..0] = 8,192: x2 gain, WBGR [14..0] = 12,288: x3 gain, WBGR [14..0] = 16,384: x4 gain, WBGR [14..0] = 20,480: x5 gain, WBGR [14..0] = 24,576: x6 gain, WBGR [14..0] = 28,672: x7 gain, WBGR [14..0] = 32,768: x8 gain *WBGR [14..8]: ECH																																
3DH: WBGB [7:0]	[White Balance GB gain] Default data: WBGB [14..0] = 4,096, Data range (WBGB [7..0]): 0 to 255 Set the Green gain on Bayer GB line Video level = (Input video level - CLAMP [7..0]) * WBGB [15..0] / 4,096 + CLAMP [7..0] WBGB [14..0] = 4,096: x1 gain, WBGB [14..0] = 8,192: x2 gain, WBGB [14..0] = 12,288: x3 gain, WBGB [14..0] = 16,384: x4 gain, WBGB [14..0] = 20,480: x5 gain, WBGB [14..0] = 24,576: x6 gain, WBGB [14..0] = 28,672: x7 gain, WBGB [14..0] = 32,768: x8 gain *WBGB [14..8]: EDH																																
4FH: GAMMA_LEVEL [3:0]	[Gamma Level Setting] Default data: GAMMA_LEVEL [3..0] = 15, Data range: 0 to 15 Sets the Gamma level setting for the gamma table function. <table border="1" style="width: 100%; border-collapse: collapse;"> <tr> <td style="width: 12.5%;">D7</td> <td style="width: 12.5%;">D6</td> <td style="width: 12.5%;">D5</td> <td style="width: 12.5%;">D4</td> <td style="width: 12.5%;">D3</td> <td style="width: 12.5%;">D2</td> <td style="width: 12.5%;">D1</td> <td style="width: 12.5%;">D0</td> </tr> <tr> <td colspan="2">D7</td> <td colspan="3">Lookup table gamma correction</td> <td colspan="2">0: With Gamma correction between two points</td> <td>1: Without Gamma correction between two points</td> </tr> <tr> <td colspan="2">D6 to D4</td> <td colspan="3">No Function</td> <td colspan="3">Always set as "000"</td> </tr> <tr> <td colspan="2">D3 to D0</td> <td colspan="3">Gamma level</td> <td colspan="3"></td> </tr> </table> <p>Please refer "Lookup table (Gamma)" for</p>	D7	D6	D5	D4	D3	D2	D1	D0	D7		Lookup table gamma correction			0: With Gamma correction between two points		1: Without Gamma correction between two points	D6 to D4		No Function			Always set as "000"			D3 to D0		Gamma level					
D7	D6	D5	D4	D3	D2	D1	D0																										
D7		Lookup table gamma correction			0: With Gamma correction between two points		1: Without Gamma correction between two points																										
D6 to D4		No Function			Always set as "000"																												
D3 to D0		Gamma level																															
76H: EXT_HB [7..0] 77H: EXT_HB [11..8]	[Horizontal cycle extend time] Default: E Horizontal cycle extended time = EXT_H (13.468 nseconds = 1 / Pixel clock frequ) Please refer "The image data transferrin																																

(888)687-6877

ELECTRONIC GROUP, INC

aegis-g2@aegiselect.com



Command No.	Command Description																				
78H: TESTP [7:0]	<p>[Test Pattern] Default data: TESTP [7..0] = 00H Sets the output test pattern.</p> <table border="1"> <tr> <td>D7</td><td>D6</td><td>D5</td><td>D4</td><td>D3</td><td>D2</td><td>D1</td><td>D0</td> </tr> </table> <table border="1"> <tr> <td>D7 to D3</td> <td>No Function</td> <td colspan="2">Always set as "00000"</td> </tr> <tr> <td rowspan="3">D2 to D0</td> <td rowspan="3">Test Pattern</td> <td>0: Off (Video output)</td> <td>1: Gray scale image</td> </tr> <tr> <td>2: Lamp image</td> <td>3: White image</td> </tr> <tr> <td>4: Color bar image</td> <td>Others: Black image</td> </tr> </table>	D7	D6	D5	D4	D3	D2	D1	D0	D7 to D3	No Function	Always set as "00000"		D2 to D0	Test Pattern	0: Off (Video output)	1: Gray scale image	2: Lamp image	3: White image	4: Color bar image	Others: Black image
D7	D6	D5	D4	D3	D2	D1	D0														
D7 to D3	No Function	Always set as "00000"																			
D2 to D0	Test Pattern	0: Off (Video output)	1: Gray scale image																		
		2: Lamp image	3: White image																		
		4: Color bar image	Others: Black image																		
80H: E2P [7..0]	<p>[EEPROM control] Default data: E2P[7:0] = 00H Controls the data writing to the EEPROM.</p> <table border="1"> <tr> <td>D7</td><td>D6</td><td>D5</td><td>D4</td><td>D3</td><td>D2</td><td>D1</td><td>D0</td> </tr> </table> <table border="1"> <tr> <td>D7 to D1</td> <td>No Function</td> <td colspan="2">Always set as "0000000"</td> </tr> <tr> <td>D0</td> <td>Data writes to the EEPROM</td> <td>0: Prohibited</td> <td>1: Accept</td> </tr> </table> <p>Note: This bit is cleared to "0" automatically after the data writes into the EEPROM.</p>	D7	D6	D5	D4	D3	D2	D1	D0	D7 to D1	No Function	Always set as "0000000"		D0	Data writes to the EEPROM	0: Prohibited	1: Accept				
D7	D6	D5	D4	D3	D2	D1	D0														
D7 to D1	No Function	Always set as "0000000"																			
D0	Data writes to the EEPROM	0: Prohibited	1: Accept																		
90H:VASA [7..0] 91H:VASA [15..8]	<p>[Vertical ROI_A Start line] Default data: VASA [15..0] = 0, Data range: 0 to 2,044 Sets the start line (vertical) of the ROI. The actual start line of the ROI = this value (VASA) + 1</p>																				
A0H:VAHA [7..0] A1H:VAHA [15..8]	<p>[Vertical ROI_A Effective lines] Default data: VAHA [15..0] = 2,048, Data range: 4 to 2,048, Data adjustable unit: 4 lines Sets the effective lines (image height) of the ROI.</p>																				
B0H:HASA [7..0] B1H:HASA [15..8]	<p>[Horizontal ROI_A Start pixel] Default data: HASA [15..0] = 0, Data range: Color: 0 to 2,446, Monochrome: 0 to 2,447, Data adjustable unit: Color: 2 pixels, Monochrome: 1 pixel Sets the start pixel (horizontal) of the ROI. The actual start pixel of the ROI = this value (HASA) + 1</p>																				
C0H:HAWA [7..0] C1H:HAWA [15..8]	<p>[Horizontal ROI_A Effective pixels] Default data: HAWA [15..0] = 2,448, Data range: 2TAP: 2 to 2,448, 3TAP: 3 to 2,448, Data adjustable unit: 2TAP: 2 pixels, 3TAP: 3 pixels Sets the effective pixels (image width, DVAL, LVAL) of ROI.</p>																				
D0H: DEF_M[7..0]	<p>[Pixel defect correction control] Default data: PDC0 [7..0] = 0</p> <table border="1"> <tr> <td>D7</td><td>D6</td><td>D5</td><td>D4</td><td>D3</td><td>D2</td><td>D1</td><td>D0</td> </tr> </table> <table border="1"> <tr> <td>D7</td> <td>Set coordinate of pixel defect position</td> <td>0 to 1: Set the coordinate of the pixel defect position Sets the correspond positions in D2H to D5H registers to the pixel defect coordinate number is assigned in D1H register. (This bit is cleared to "0" automatically after sets the coordinate of the pixel defect position)</td> </tr> <tr> <td>D6</td> <td>Load coordinate of pixel defect position</td> <td>0 to 1: Read the coordinate of the pixel defect position Reads the pixel defect coordinate number is assigned in D1H register corresponding position to D6H to D9H registers. (This bit is cleared to "0" automatically after reads the coordinate of the pixel defect position)</td> </tr> <tr> <td>D5</td> <td>Save coordinate of defect pixel position into the EEPROM</td> <td></td> </tr> <tr> <td>D4 to D0</td> <td>No Function</td> <td></td> </tr> </table>	D7	D6	D5	D4	D3	D2	D1	D0	D7	Set coordinate of pixel defect position	0 to 1: Set the coordinate of the pixel defect position Sets the correspond positions in D2H to D5H registers to the pixel defect coordinate number is assigned in D1H register. (This bit is cleared to "0" automatically after sets the coordinate of the pixel defect position)	D6	Load coordinate of pixel defect position	0 to 1: Read the coordinate of the pixel defect position Reads the pixel defect coordinate number is assigned in D1H register corresponding position to D6H to D9H registers. (This bit is cleared to "0" automatically after reads the coordinate of the pixel defect position)	D5	Save coordinate of defect pixel position into the EEPROM		D4 to D0	No Function	
D7	D6	D5	D4	D3	D2	D1	D0														
D7	Set coordinate of pixel defect position	0 to 1: Set the coordinate of the pixel defect position Sets the correspond positions in D2H to D5H registers to the pixel defect coordinate number is assigned in D1H register. (This bit is cleared to "0" automatically after sets the coordinate of the pixel defect position)																			
D6	Load coordinate of pixel defect position	0 to 1: Read the coordinate of the pixel defect position Reads the pixel defect coordinate number is assigned in D1H register corresponding position to D6H to D9H registers. (This bit is cleared to "0" automatically after reads the coordinate of the pixel defect position)																			
D5	Save coordinate of defect pixel position into the EEPROM																				
D4 to D0	No Function																				
D1H: PDC1[7..0]	<p>[Pixel defect correction coordinate number] Sets the coordinate number of the pixel c</p> <table border="1"> <tr> <td>D7</td><td>D6</td><td>D5</td><td>D4</td><td>D3</td><td>D2</td> </tr> </table> <table border="1"> <tr> <td>D7 to D0</td> <td>Pixel defect correction coordinate number</td> </tr> </table>	D7	D6	D5	D4	D3	D2	D7 to D0	Pixel defect correction coordinate number												
D7	D6	D5	D4	D3	D2																
D7 to D0	Pixel defect correction coordinate number																				

**Aegis** (888)687-6877  
ELECTRONIC GROUP, INC  
aegis-g2@aegiselect.com



Command No.	Command Description																				
D2H: PDC_WX [7..0] D3H: PDC_WX [15..8]	[Pixel defect X position (Set)] Default data: PDC_WX [15..0] = 0, Data range: 0 to 2,448 Sets the X (horizontal) coordinate position of the defect pixel for set the position.																				
D4H: PDC_WY [7..0] D5H: PDC_WY [15..8]	[Pixel defect Y position (Set)] Default data: PDC_WY [15..0] = 0, Data range: 0 to 2,048 Sets the Y (vertical) coordinate position of the defect pixel for set the position.																				
D6H: PDC_RX [7..0] D7H: PDC_RX [15..8]	[Pixel defect X position (Read)] Default data: PDC_RX [15..0] = 0 Sets the X (horizontal) coordinate position of the defect pixel for read the position.																				
D8H: PDC_RY [7..0] D9H: PDC_RY [15..8]	[Pixel defect Y position (Read)] Default data: PDC_RY [15..0] = 0 Sets the Y (vertical) coordinate position of the defect pixel for read the position.																				
DEH: DEF_M [7..0]	[Pixel defect correction mode] Default data: DEF_M [7..0] = 1 <table border="1" style="width: 100%; border-collapse: collapse;"> <tr> <td style="width: 12.5%;">D7</td> <td style="width: 12.5%;">D6</td> <td style="width: 12.5%;">D5</td> <td style="width: 12.5%;">D4</td> <td style="width: 12.5%;">D3</td> <td style="width: 12.5%;">D2</td> <td style="width: 12.5%;">D1</td> <td style="width: 12.5%;">D0</td> </tr> </table> <table border="1" style="width: 100%; border-collapse: collapse;"> <tr> <td style="width: 25%;">D7 to D2</td> <td style="width: 50%;">No Function</td> <td colspan="2" style="width: 25%;">Always set as "0000000"</td> </tr> <tr> <td>D1</td> <td>Highlight the corrected pixel</td> <td style="width: 25%;">0: Disable</td> <td style="width: 25%;">1: Enable</td> </tr> <tr> <td>D0</td> <td>Pixel defect correction</td> <td>0: Disable</td> <td>1: Enable</td> </tr> </table> <p>The corrected pixel is appeared with the highlight when "Highlight the corrected pixel" is enabled.</p>	D7	D6	D5	D4	D3	D2	D1	D0	D7 to D2	No Function	Always set as "0000000"		D1	Highlight the corrected pixel	0: Disable	1: Enable	D0	Pixel defect correction	0: Disable	1: Enable
D7	D6	D5	D4	D3	D2	D1	D0														
D7 to D2	No Function	Always set as "0000000"																			
D1	Highlight the corrected pixel	0: Disable	1: Enable																		
D0	Pixel defect correction	0: Disable	1: Enable																		
EAH: WBR [14..8]	[White Balance R Gain] Default data: WBR [14..0] = 4,096, Data range (WBR [14..8]): 0 to 127 Sets the Red gain on Bayer Video level = (Input video level - CLAMP [7..0]) * WBR [14..0] / 4,096 + CLAMP [7..0] WBR [14..0] = 4,096: x1 gain, WBR [14..0] = 8,192: x2 gain, WBR [14..0] = 12,288: x3 gain, WBR [14..0] = 16,384: x4 gain, WBR [14..0] = 20,480: x5 gain, WBR [14..0] = 24,576: x6 gain, WBR [14..0] = 28,672: x7 gain, WBR [14..0] = 32,768: x8 gain *WBR [7:0]: 3AH																				
EBH: WBB [14..8]	[White Balance B Gain] Default data: WBB [14..0] = 4,096, Data range (WBB [14..8]): 0 to 127 Sets the Blue gain on Bayer Video level = (Input video level - CLAMP [7..0]) * WBB [14..0] / 4,096 + CLAMP [7..0] WBB [14..0] = 4,096: x1 gain, WBB [14..0] = 8,192: x2 gain, WBB [14..0] = 12,288: x3 gain, WBB [14..0] = 16,384: x4 gain, WBB [14..0] = 20,480: x5 gain, WBB [14..0] = 24,576: x6 gain, WBB [14..0] = 28,672: x7 gain, WBB [14..0] = 32,768: x8 gain *WBB [7:0]: 3BH																				
ECH: WBGR [14..8]	[White Balance GR Gain] Default data: WBGR [14..0] = 4,096, Data range (WBGR [14..8]): 0 to 127 Sets the Green gain on Bayer GR line Video level = (Input video level - CLAMP [7..0]) * WBGR [14..0] / 4,096 + CLAMP [7..0] WBGR [14..0] = 4,096: x1 gain, WBGR [14..0] = 8,192: x2 gain, WBGR [14..0] = 12,288: x3 gain, WBGR [14..0] = 16,384: x4 gain, WBGR [14..0] = 20,480: x5 gain, WBGR [14..0] = 24,576: x6 gain, WBGR [14..0] = 28,672: x7 gain, WBGR [14..0] = 32,768: x8 gain *WBGR [7:0]: 3CH																				
EDH: WBGB [14..8]	[White Balance GB Gain] Default data: WBGB [14..0] = 4,096, Data range (WBGB [14..8]): 0 to 127 Sets the Green gain on Bayer GB line Video level = (Input video level - CLAMP [7..0]) * WBGB [14..0] / 4,096 + CLAMP [7..0] WBGB [14..0] = 4,096: x1 gain, WBGB [14..0] = 8,192: x2 gain, WBGB [14..0] = 12,288: x3 gain, WBGB [14..0] = 16,384: x4 gain, WBGB [14..0] = 20,480: x5 gain, WBGB [14..0] = 24,576: x6 gain, WBGB [14..0] = 28,672: x7 gain, WBGB [14..0] = 32,768: x8 gain *WBGB [7:0]: 3DH																				
EEH: MOD6 [7..0]	[The camera function mode] Default data: MOD6 [7..0] = 0 Sets the camera TAP number for each sensor <table border="1" style="width: 100%; border-collapse: collapse;"> <tr> <td style="width: 12.5%;">D7</td> <td style="width: 12.5%;">D6</td> <td style="width: 12.5%;">D5</td> <td style="width: 12.5%;">D4</td> <td style="width: 12.5%;">D3</td> <td style="width: 12.5%;">D2</td> </tr> </table> <table border="1" style="width: 100%; border-collapse: collapse;"> <tr> <td style="width: 25%;">D7 to D2</td> <td style="width: 75%;">TAP Configuration</td> </tr> </table>	D7	D6	D5	D4	D3	D2	D7 to D2	TAP Configuration												
D7	D6	D5	D4	D3	D2																
D7 to D2	TAP Configuration																				

(888)687-6877

ELECTRONIC GROUP, INC

aegis-g2@aegiselect.com

### 13.4.3 Description of the camera control commands (Bank No.: 01H)

The underline settings are the factory default settings.

Command No.	Command Description
50H: GSTEP0 [7..0]	[Lookup table (Gamma)] Default data: GSTEP0 [7..0] = 36H (Gamma = 0.45)
51H: GSTEP1 [7..0]	[Lookup table (Gamma)] Default data: GSTEP1 [7..0] = 4AH (Gamma = 0.45)
52H: GSTEP2 [7..0]	[Lookup table (Gamma)] Default data: GSTEP2 [7..0] = 58H (Gamma = 0.45)
53H: GSTEP3 [7..0]	[Lookup table (Gamma)] Default data: GSTEP3 [7..0] = 64H (Gamma = 0.45)
54H: GSTEP4 [7..0]	[Lookup table (Gamma)] Default data: GSTEP4 [7..0] = 6FH (Gamma = 0.45)
55H: GSTEP5 [7..0]	[Lookup table (Gamma)] Default data: GSTEP5 [7..0] = 79H (Gamma = 0.45)
56H: GSTEP6 [7..0]	[Lookup table (Gamma)] Default data: GSTEP6 [7..0] = 81H (Gamma = 0.45)
57H: GSTEP7 [7..0]	[Lookup table (Gamma)] Default data: GSTEP7 [7..0] = 89H (Gamma = 0.45)
58H: GSTEP8 [7..0]	[Lookup table (Gamma)] Default data: GSTEP8 [7..0] = 91H (Gamma = 0.45)
59H: GSTEP9 [7..0]	[Lookup table (Gamma)] Default data: GSTEP9 [7..0] = 98H (Gamma = 0.45)
5AH: GSTEP10 [7..0]	[Lookup table (Gamma)] Default data: GSTEP10 [7..0] = 9EH (Gamma = 0.45)
5BH: GSTEP11 [7..0]	[Lookup table (Gamma)] Default data: GSTEP11 [7..0] = A5H (Gamma = 0.45)
5CH: GSTEP12 [7..0]	[Lookup table (Gamma)] Default data: GSTEP12 [7..0] = ABH (Gamma = 0.45)
5DH: GSTEP13 [7..0]	[Lookup table (Gamma)] Default data: GSTEP13 [7..0] = B0H (Gamma = 0.45)
5EH: GSTEP14 [7..0]	[Lookup table (Gamma)] Default data: GSTEP14 [7..0] = B6H (Gamma = 0.45)
5FH: GSTEP15 [7..0]	[Lookup table (Gamma)] Default data: GSTEP15 [7..0] = BBH (Gamma = 0.45)
60H: GSTEP16 [7..0]	[Lookup table (Gamma)] Default data: GSTEP16 [7..0] = C1H (Gamma = 0.45)
61H: GSTEP17 [7..0]	[Lookup table (Gamma)] Default data: GSTEP17 [7..0] = C6H (Gamma = 0.45)
62H: GSTEP18 [7..0]	[Lookup table (Gamma)] Default data: GSTEP18 [7..0] = CAH (Gamma = 0.45)
63H: GSTEP19 [7..0]	[Lookup table (Gamma)] Default data: GSTEP19 [7..0] = CFH (Gamma = 0.45)
64H: GSTEP20 [7..0]	[Lookup table (Gamma)] Default data: GSTEP20 [7..0] = D4H (Gamma = 0.45)
65H: GSTEP21 [7..0]	[Lookup table (Gamma)] Default data: GSTEP21 [7..0] = D8H (Gamma = 0.45)
66H: GSTEP22 [7..0]	[Lookup table (Gamma)] Default data: GSTEP22 [7..0] = DDH (Gamma = 0.45)
67H: GSTEP23 [7..0]	[Lookup table (Gamma)] Default data: GSTEP23 [7..0] = E1H (Gamma = 0.45)
68H: GSTEP24 [7..0]	[Lookup table (Gamma)] Default data: GSTEP24 [7..0] = E5H (Gamma = 0.45)
69H: GSTEP25 [7..0]	[Lookup table (Gamma)] Default data: GSTEP25 [7..0] = E9H (Gamma = 0.45)
6AH: GSTEP26 [7..0]	[Lookup table (Gamma)] Default data: GSTEP26 [7..0] = EDH (Gamma = 0.45)
6BH: GSTEP27 [7..0]	[Lookup table (Gamma)] Default data: G
6CH: GSTEP28 [7..0]	[Lookup table (Gamma)] Default data: G
6DH: GSTEP29 [7..0]	[Lookup table (Gamma)] Default data: G
6EH: GSTEP30 [7..0]	[Lookup table (Gamma)] Default data: G
6FH: GSTEP31 [7..0]	[Lookup table (Gamma)] Default data: G

**(888)687-6877**  
 ELECTRONIC GROUP, INC  
[aegis-g2@aegiselect.com](mailto:aegis-g2@aegiselect.com)

---

#### 13.4.4 Command sequence for the data saves to the EEPROM

Please follow the command sequence in below for the data saves to the EEPROM.

- 1) Sets "1" to command 80H.0 to accept "write control to the EEPROM".
- 2) Sends the EEPROM write command with data, which sets "1" for the page selection.
- 3) The camera sends back one of the below receiving code after the EEPROM write command is proceeding.  
01H: Data saves to the EEPROM correctly  
10H: EEPROM write error
- 4) Command 80H.0 is changed to "0" automatically after the EEPROM write command is proceeding.

Note.1) The data does not save into the EEPROM when the command 80H.0 is "0".

Note.2) The data of the multiple continuous commands can save to the EEPROM by one sets of above sequence (1) to 4)).  
e.g. Multiple continuous command: "10H, 11H, 12H and 13H" or "22H, 23H and 24H".

Note.3) When save the data of the multiple commands, which is not continuous commands, to the EEPROM, it is necessary to operate the multiple sets of above sequence (1) to 4)).  
e.g. Multiple commands: "10H, 13H, 19H and 1BH" or "20H, 23H and 25H".

Aegis Electronic Group, Inc.

---

 (888)687-6877  
ELECTRONIC GROUP, INC  
aegis-g2@aegiselect.com

## 14 Revision History

Rev	Date	Changes	Note
00	2016/11/29	New Document	
01	2017/07/03	Revised Change the name of company	
02	2019/01/22	Revised Change "Image Data Transferring Speed"	
03	2019/02/27	Revised Added trademark information	

Aegis Electronic Group, Inc.

**(888)687-6877**  
 ELECTRONIC GROUP, INC  
**aegis-g2@aegiselect.com**

Camera Link (including PoCL) is trademark of AIA.  
 Other company names and product names in this document are trademarks of their respective owners.

Aegis Electronic Group, Inc.

---

*Aegis* (888)687-6877  
ELECTRONIC GROUP, INC  
aegis-g2@aegiselect.com