



GigE Vision Camera SXGA Color / Monochrome CCD

STC-SC152POEHS / STC-SB152POEHS

User's Guide

Aegis Electronic Group, Inc.

OMRON SENTECH CO., LTD.

Table of Contents

1	Connector Specifications	3
1.1	RJ45 Connector	3
1.2	Power-I/O connector	4
1.2.1	Equivalent Circuit for the Input Pin of the I/O Connector	6
1.2.2	Typical Input circuit	7
1.2.3	Typical output circuit	7
1.2.4	Input and Output Signal Timing (Hardware Trigger)	8
1.2.5	Input and Output Signal Timing (Software Trigger)	9
1.2.6	Trigger Signal Processing Process	10
2	Camera Output Timing Charts	11
2.1	Horizontal Timing	11
2.1.1	Color Bayer order (This information is only for STC-SC152POEHS)	11
2.2	Vertical Timing	12
2.2.1	Full scanning	12
2.2.2	ROI (Region of Interest)	13
2.3	Pixel Transferring Image	14
3	Camera Operational Modes	15
3.1	Normal Mode	15
3.2	Pulse Width Trigger Mode	15
3.2.1	Timing	15
3.2.2	Exposure Timing with the Positive Polarity Trigger Signal	16
3.2.3	Exposure Timing with the Negative Polarity Trigger Signal	16
3.3	Edge Preset Trigger Mode	17
3.3.1	Timing	17
3.3.2	Exposure Timing with the Positive Polarity Trigger Signal	18
3.3.3	Exposure timing with the negative polarity trigger signal	18
3.4	Edge Preset Trigger Mode (Trigger Input While the Image Is Out)	19
3.4.1	Timing	19
3.4.2	Exposure Timing with the Positive Polarity Trigger Signal	20
3.4.3	Exposure Timing with the Negative Polarity Trigger Signal	20
3.5	H Reset Mode	21
4	Communication Protocol	22
4.1	Communication Method	22
4.2	Communication Settings	22
4.3	Communication Format	22
4.4	Camera Control Command	25
4.4.1	Camera Command List (Device Code: 000000)	25
4.4.2	Camera Command List (Device Code: 100000)	27
4.4.3	Descriptions of the Camera Commands (Device code: 000000);	29
4.4.4	Descriptions of the Camera Commands (Device code: 100000);	34
4.1	enlCam Command / Camera Command Reference Table	41
5	Saving and Loading a User Set data	44
5.1.1	When the Camera is Saving the Parameters	44
5.1.2	When the Camera is Loading the Parameters	44
5.1.3	When the Camera is Running	45
5.1.4	Camera initialization (Factory Defaults)	45
6	Revision History	46

1 Connector Specifications

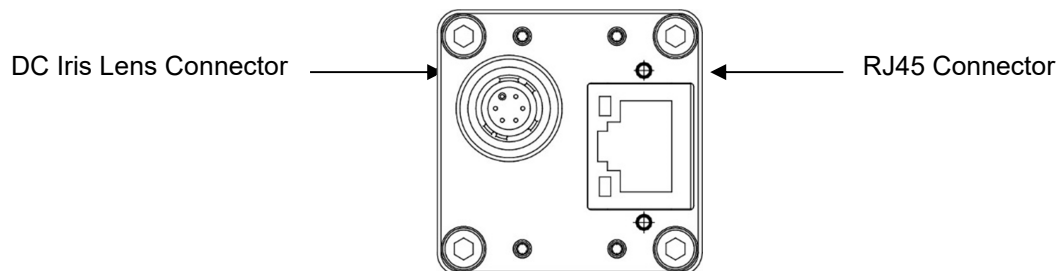

1.1 RJ45 Connector

This product is NOT a PoE type. Apply power (+10.8 to +26.4Vdc) ONLY through the I/O connector.

Pin Assignment:

Pin No.	Signal Name
1	TA+
2	TA-
3	TB+
4	TC+
5	TC-
6	TB-
7	TD+
8	TD-

LED Information:

Green LED	Yellow LED	Status
Green Light ON	Orange Light ON	Power ON
Green Light ON	Orange Light Blinking	1Gb Transferring
Light OFF	Orange Light Blinking	100 Mb Transferring

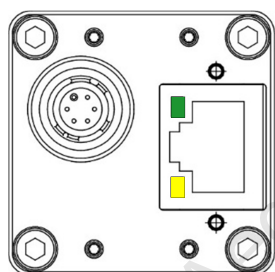

The camera is powered-on

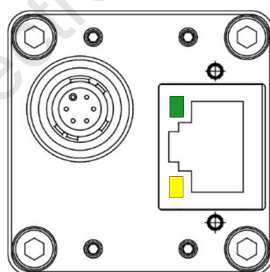

Green light: ON
Yellow light: Blinking
1 Gb Transferring

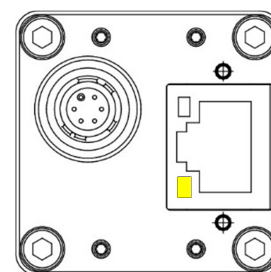

Green light: OFF
Yellow light: Blinking
100 Mb Transferring

Please use a 1Gb supported NIC, Network Switch and LAN cable. Check that the NIC and Network Switch being used is "1Gb transferring".

NIC and Network Switch support 1Gb. Please confirm the setting on 1Gb transfer.

As for the actual connection, please refer another document "System Configuration".

1.2 Power-I/O connector

- HR10A-7R-6PB (Hirose) or equivalent
- This connector is for the power supply (12Vdc) and input /output signals.
- Use HR10A-7P-6S (Hirose) or equivalent for the cable side.

Pin Assignment

Pin No.	Signal Name	IN / OUT	Voltage
1	GND	IN	0V
2	I/O-1	OUT	Open Collector
3	I/O-2	OUT	Open Collector
4	TRG_In-	IN	Low: Smaller than +1.0V (Opt. Isolated -) High: +3.0 to +26.4V (Opt. Isolated +) *potential difference between TRG_In- and TRG_In+
5	TRG_In+	IN	
6	POWER IN	IN	+10.8 to +26.4 Vdc

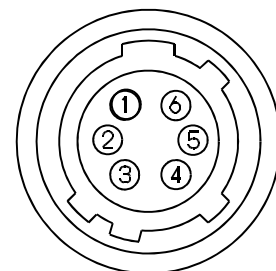

- Output signals can be assigned through the camera setting communication.
(Device Code = 00H, Command = F0H and F1H)

IO Signal Patterns for Pin No.2 (I/O-1) and Pin No.3 (I/O-2)

Command No.				GenICam
F0H[3..0]	F1[3]	F0H[7..4]	F1[4]	I/O-1 (Pin No.2) / I/O-2 (Pin No.3)
For I/O-1 (Pin No. 2)		For I/O-2 (Pin No.3)		
0H (initial setting)	-	0H	-	FrameTriggerWait (initial setting for I/O-1)
1H	Set Value	1H	Set Value	UserOutput
2H	-	2H (initial setting)	-	ExposureActive (initial setting for I/O-2)
3H	-	3H	-	TriggerAuxiliary
4H	-	4H	-	TriggerInternal
5H	-	5H	-	SensorReadOut
6H	-	6H	-	StrobeSignal
7H-FH	-	7H-FH	-	For Test Use Only

Note: I/O-1 can be assigned only by F0H[3..0] and F1[3], and I/O-2 can be assigned only by F0H[7..4] and F1[4].

1) FrameTriggerWait

The user can check the camera condition (camera exposure and image output processing by the trigger signal with this FrameTriggerWait signal).

This signal is LOW for the period from the trigger input signal to the image output.

- a) High status (3.3V): No processing by the trigger signal. The camera accepts the trigger signal.
- b) Low status (0V): The camera is exposed and the image output processes by the trigger signal.

The camera default setting is the input trigger signal is INVALID while at the low status of this signal. When the exposure starts while the image output by the next trigger signal, please change the camera setting (Device code: 00H, Command No. :13H) to accept the trigger signal while the image outputs.

The noise appears on the image when the exposure begins while the image is output. The noise appears on the image when the start exposure while the image is output. In this case, please change the "H reset" for the exposure start mode (Device code: 00H, Command No. : 12H) to change the exposure start point to the next HD timing.

2) UserOutput

The status of the UserOutput signal can change with the "UserOutputValue".

3) ExposureActive

The user can check the exposure time with the ExposureActive signal.

4) TriggerAuxiliary

The TriggerAuxiliary signal is the input trigger signal.

5) TriggerInternal

The TriggerInternal signal is the input trigger signal with the trigger delay time.

6) SensorReadOut

The SensorReadOut signal is the FVAL signal, which is the image output period of the time.

7) StrobeSignal

The StrobeSignal signal is the strobe control signal.

1.2.1 Equivalent Circuit for the Input Pin of the I/O Connector

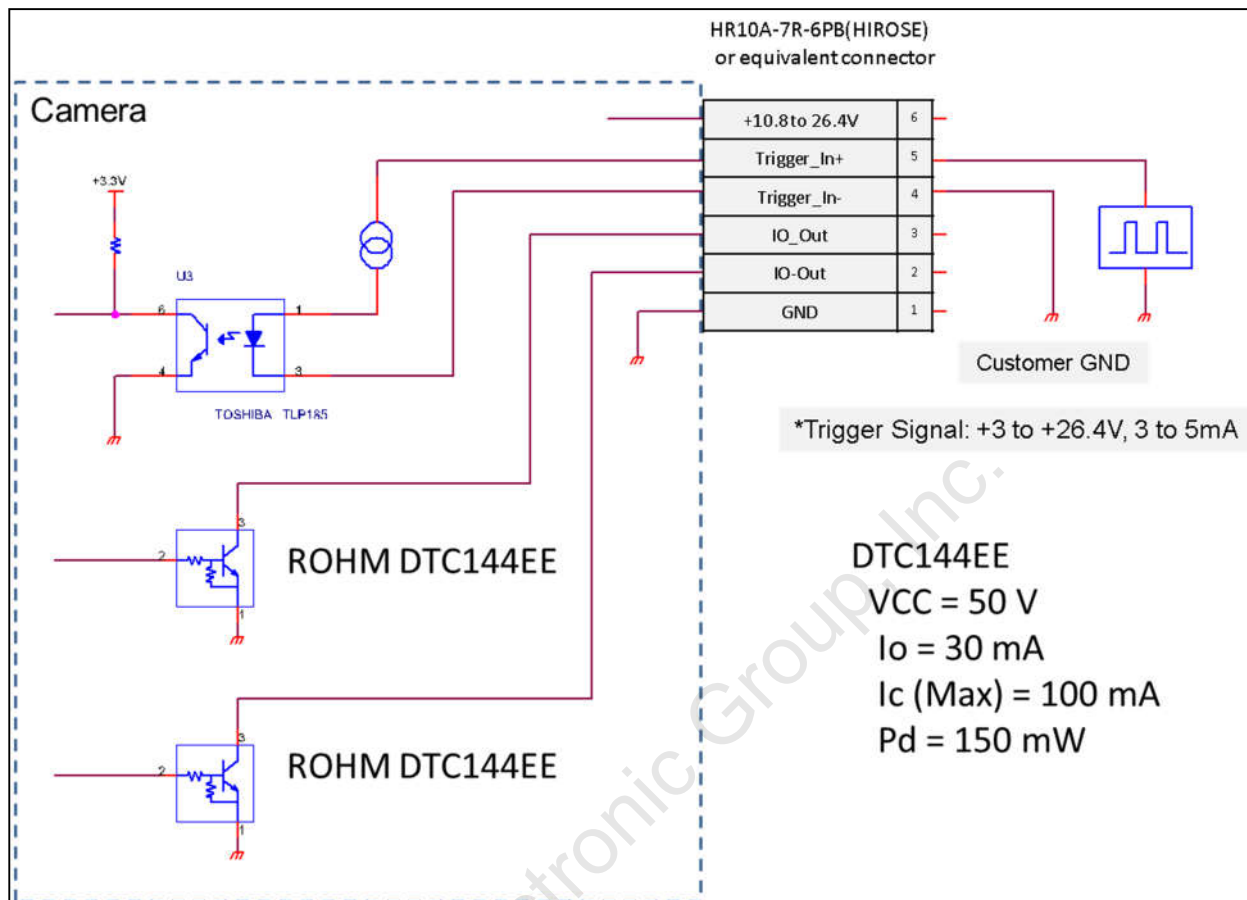

1.2.2 Typical Input circuit

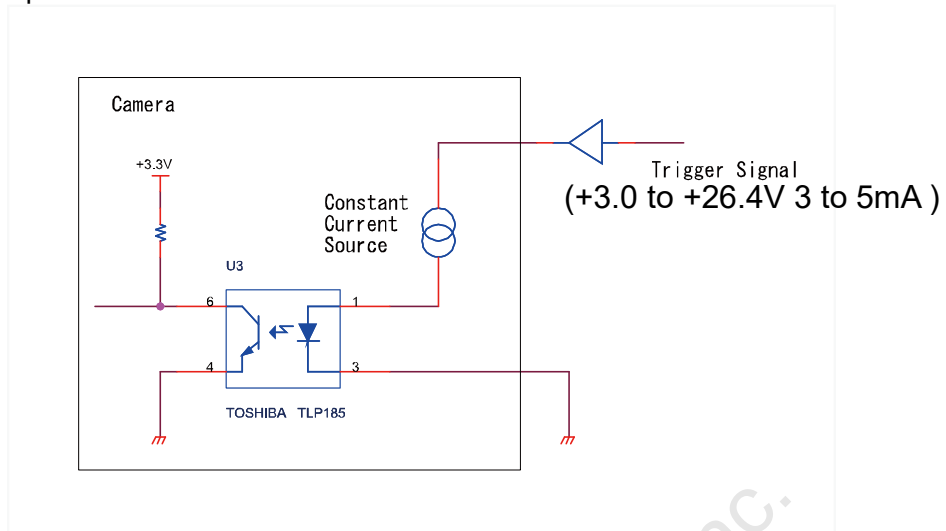

1.2.3 Typical output circuit

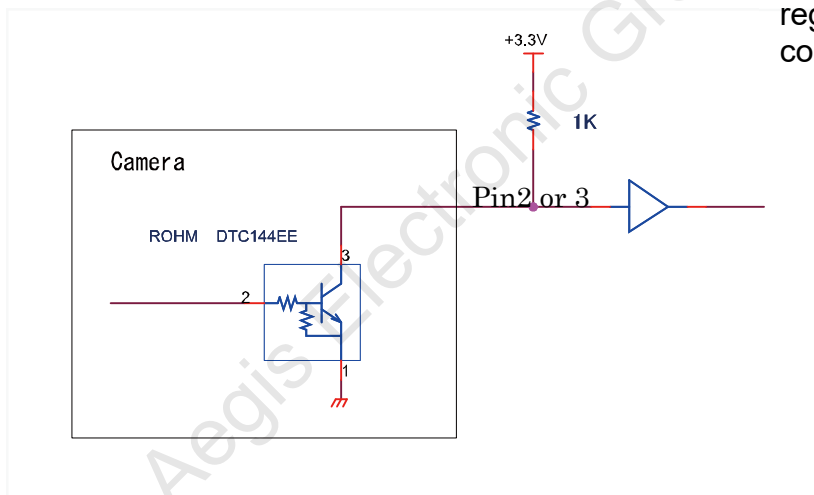

Note;
Vcc and pull-up
register can be
configurable.

1.2.4 Input and Output Signal Timing (Hardware Trigger)
 Case of "External Hardware Trigger", "Positive Edge Trigger", "Edge Preset Exposure",

Camera internal processing

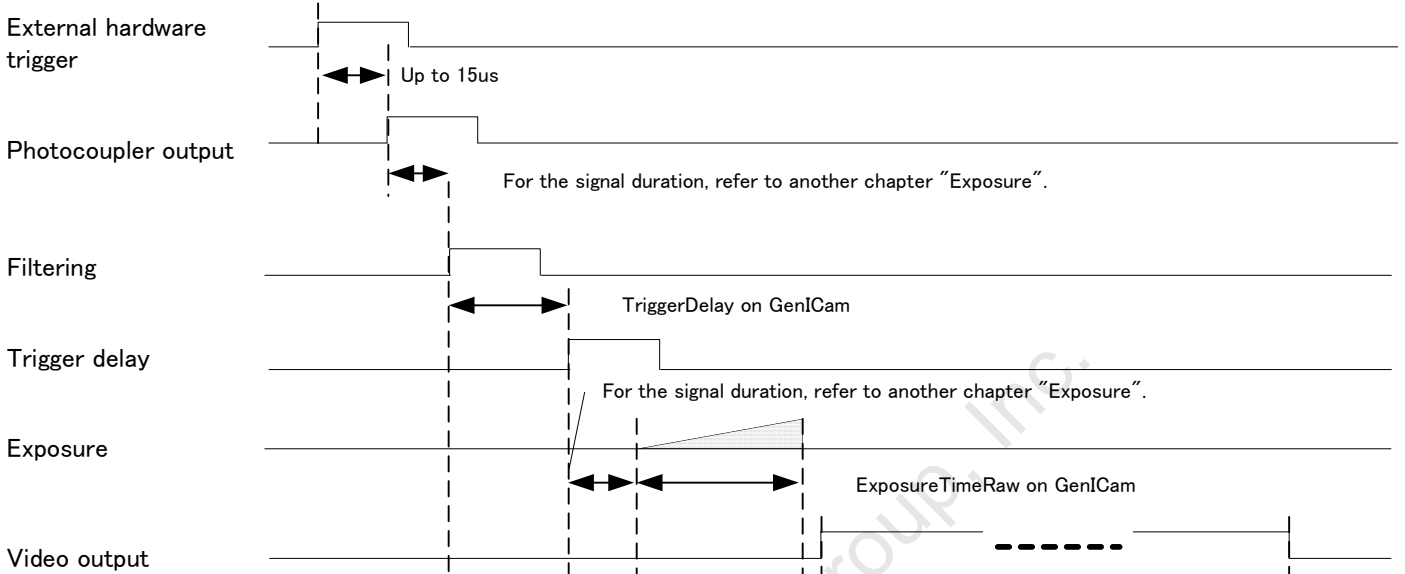

Output Signal

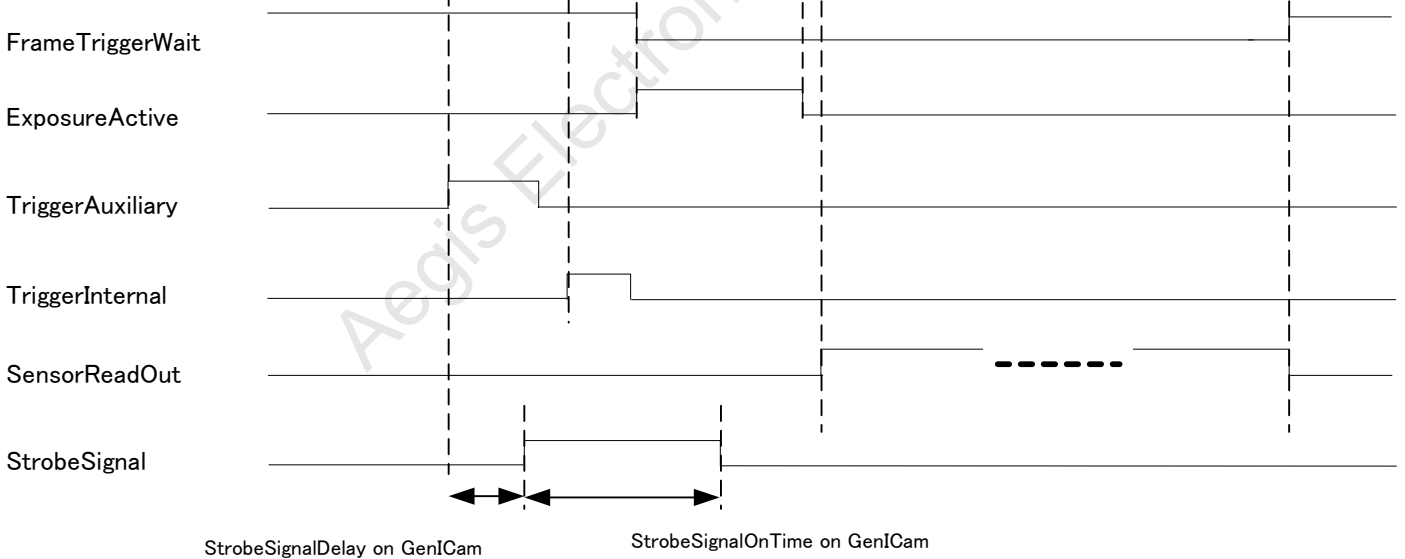

1.2.5 Input and Output Signal Timing (Software Trigger)
 Case of "Software Trigger", "Positive Edge Trigger", "Edge Preset Exposure",

Camera internal processing

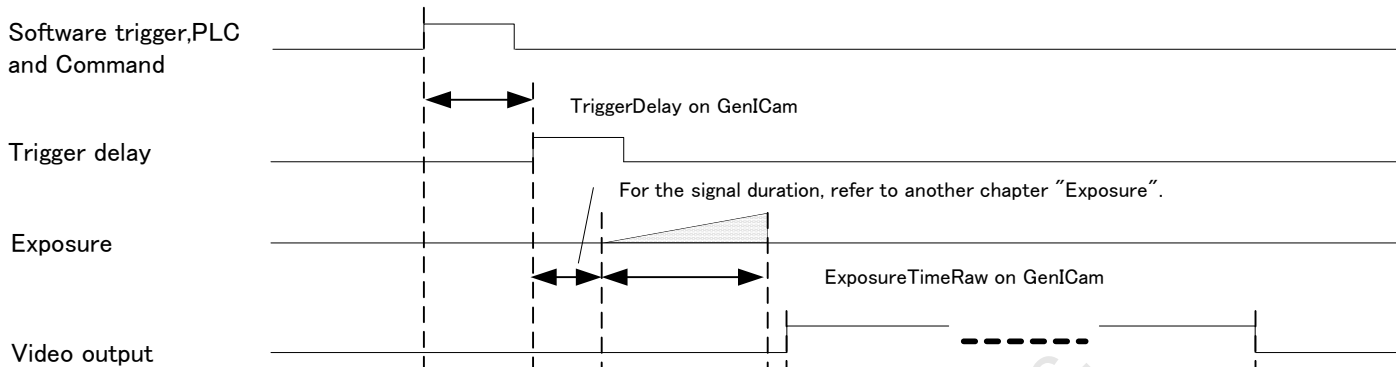

Output Signal

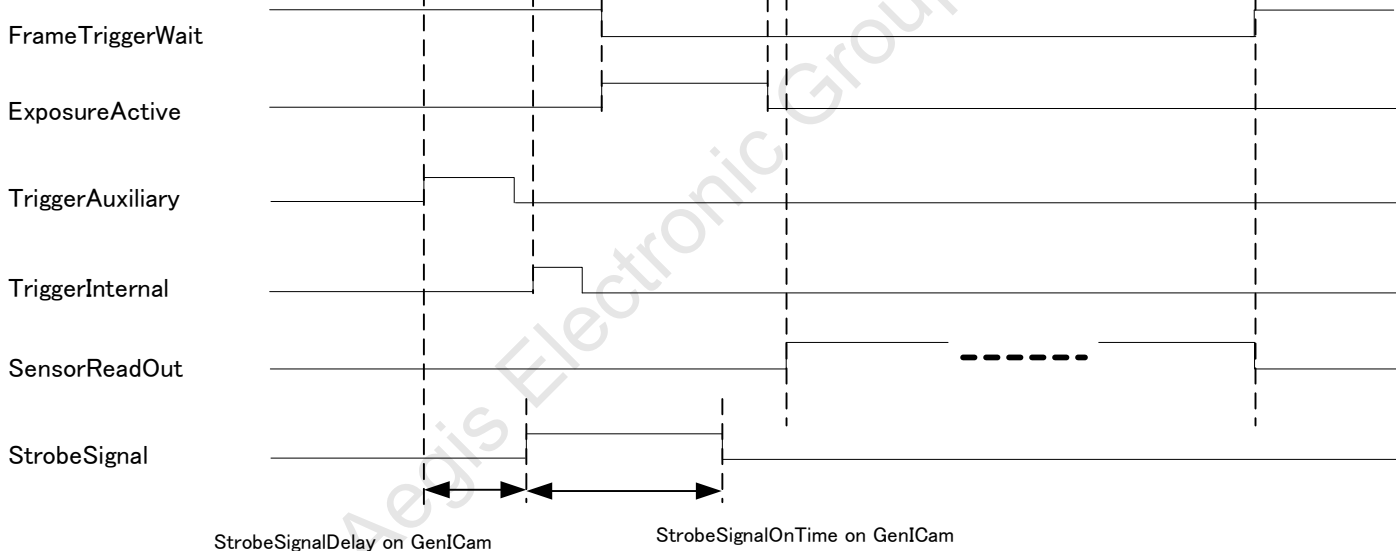

StrobeSignalDelay on GenICam StrobeSignalOnTime on GenICam

1.2.6 Trigger Signal Processing Process

External Hardware Trigger or Software Trigger input the camera's internal process as follows.

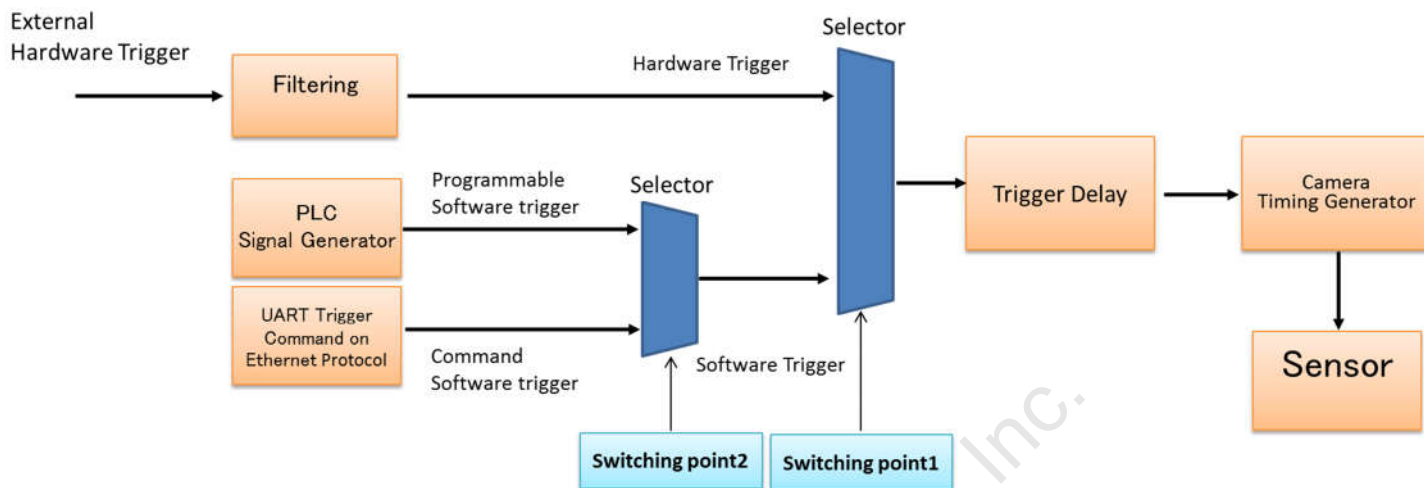

Switching Trigger can be done through register access or GenICam commands

Switching point 1 : Switch to Hardware Trigger and Software Trigger

Register: 12H.5=0

Register: 12H.5=1

TriggerSource=Software on GenICam

TriggerSource=Hardware on GenICam

Switching point 2 : Switch to PLC programmable Software trigger and command software trigger

Register: 16H.7-6=00

Register: 16H.7-6=10

GenICam ⌀ TriggerSoftwareSource=PLC

GenICam ⌀ TriggerSource=Command

2 Camera Output Timing Charts

2.1 Horizontal Timing

1 CLK = 15.2778 nseconds

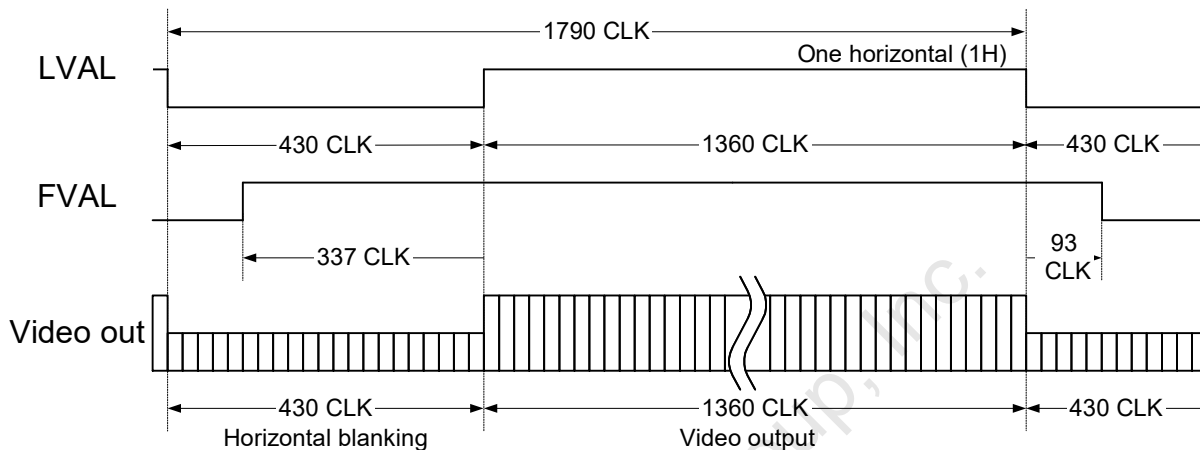

2.1.1 Color Bayer order (This information is only for STC-SC152POEHS)

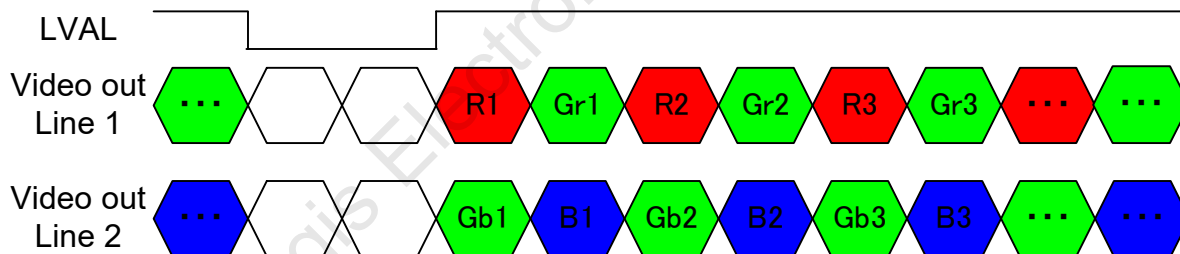

2.2 Vertical Timing

2.2.1 Full scanning

1 H = 27.3512 useconds, 34.23358 Hz

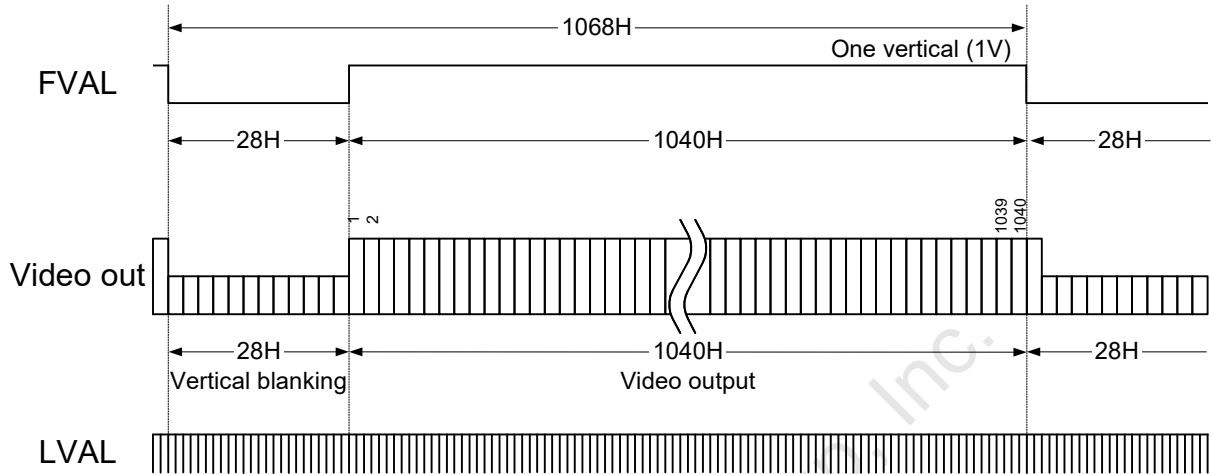

Aegis Electronic Group, Inc.

2.2.2 ROI (Region of Interest)

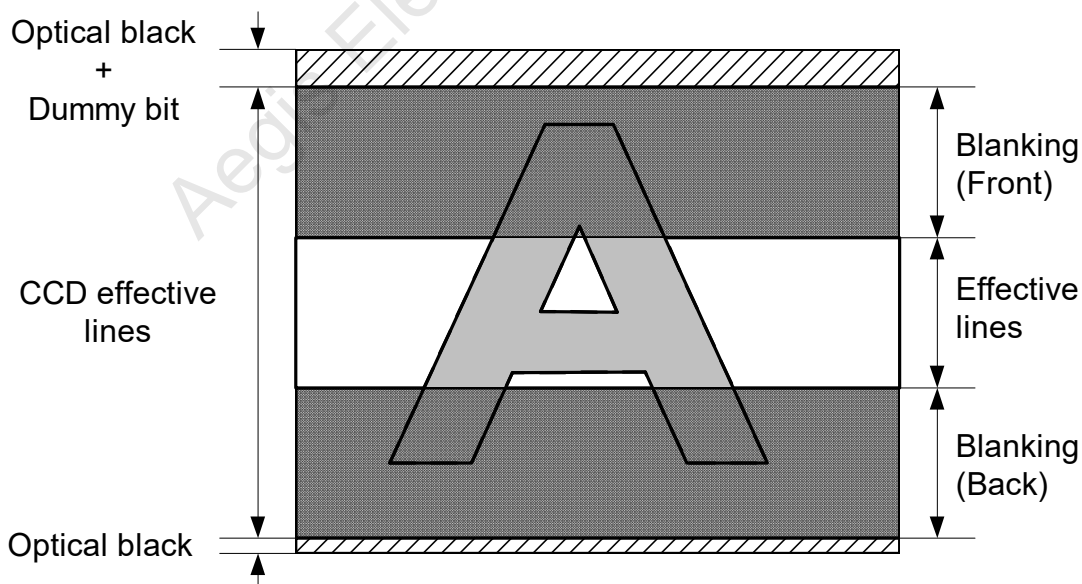
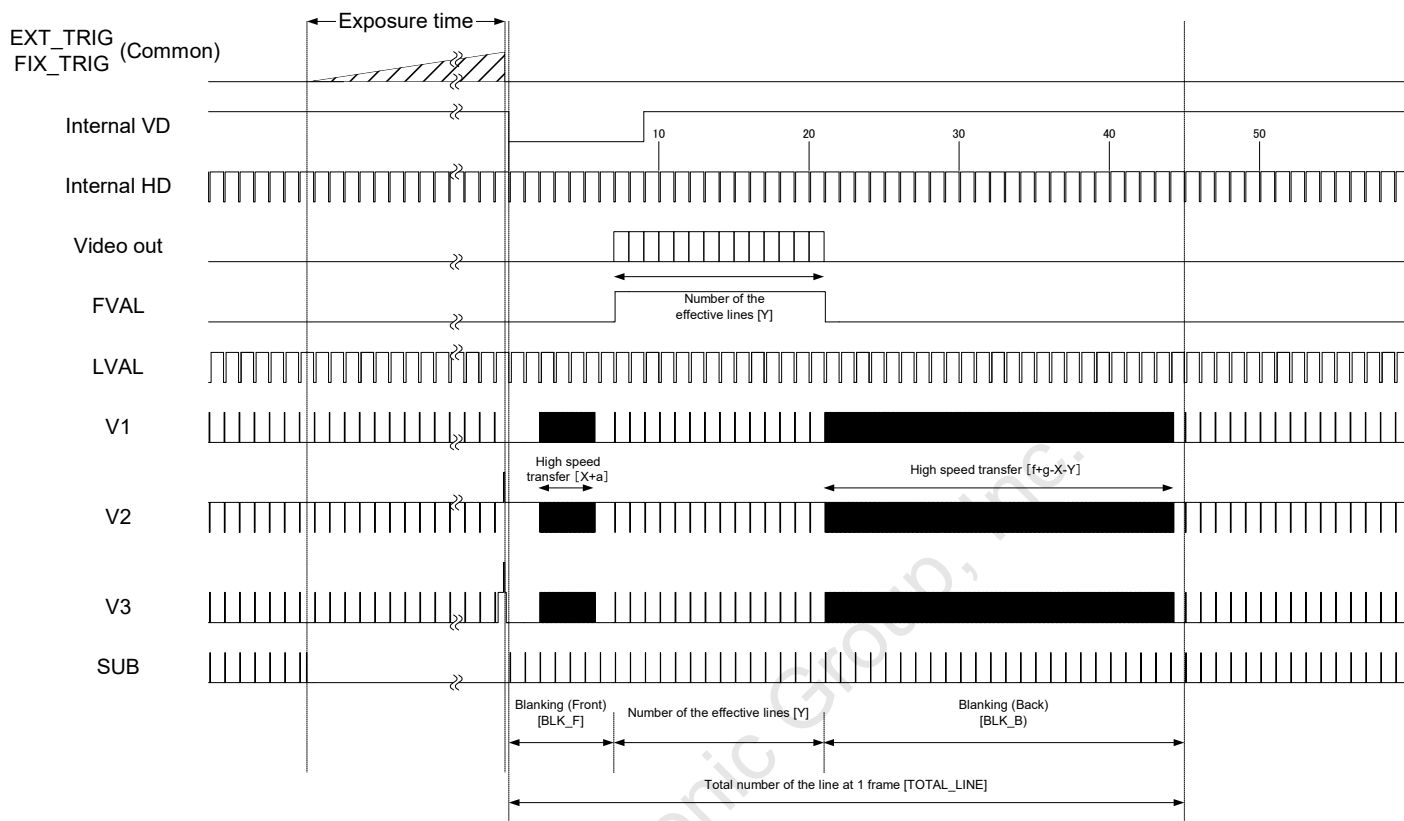

2.3 Pixel Transferring Image

STC-SB152POEHS (Monochrome)

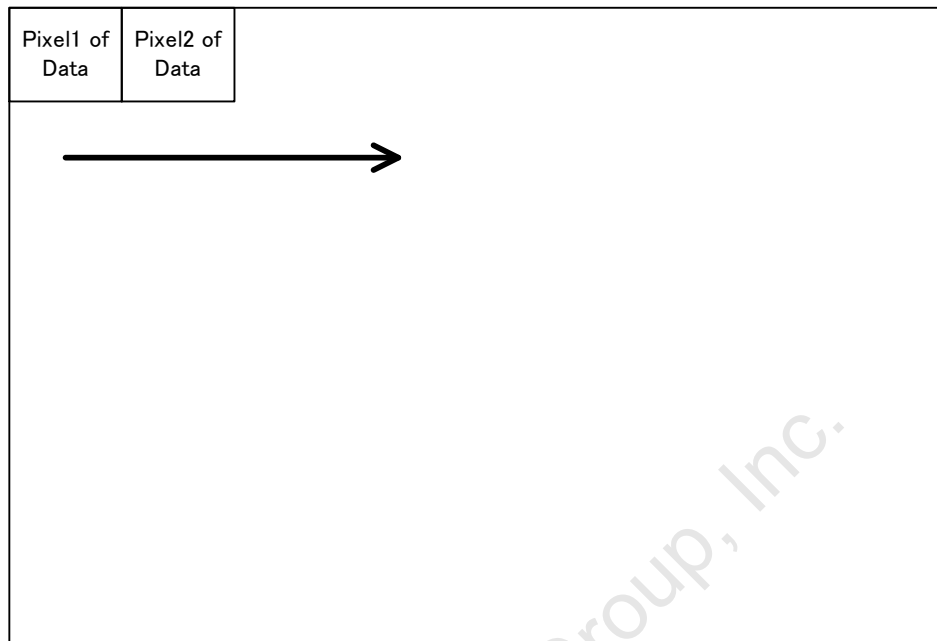

Pixel (n) of Data: nth pixel being transferred

STC-SC152POEHS (Color)

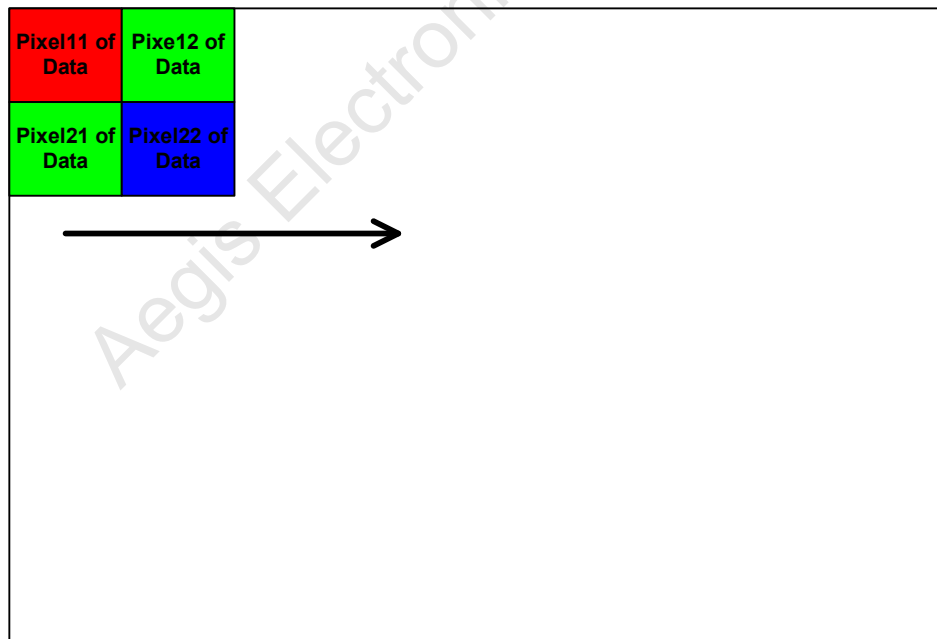

Pixel (m,n) of Data: nth pixel of the mth line being transferred

3 Camera Operational Modes

3.1 Normal Mode

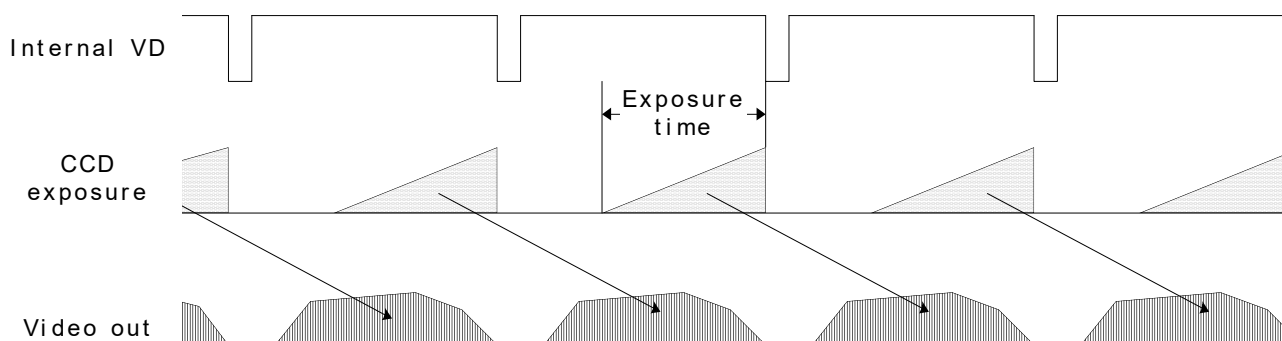

3.2 Pulse Width Trigger Mode

In this trigger mode with positive polarity, the camera exposure starts at the rising edge of the trigger pulse and stops at the falling edge of the trigger pulse. Therefore, if positive polarity exposure is selected, the exposure periods are the high states of the trigger pulse.

3.2.1 Timing

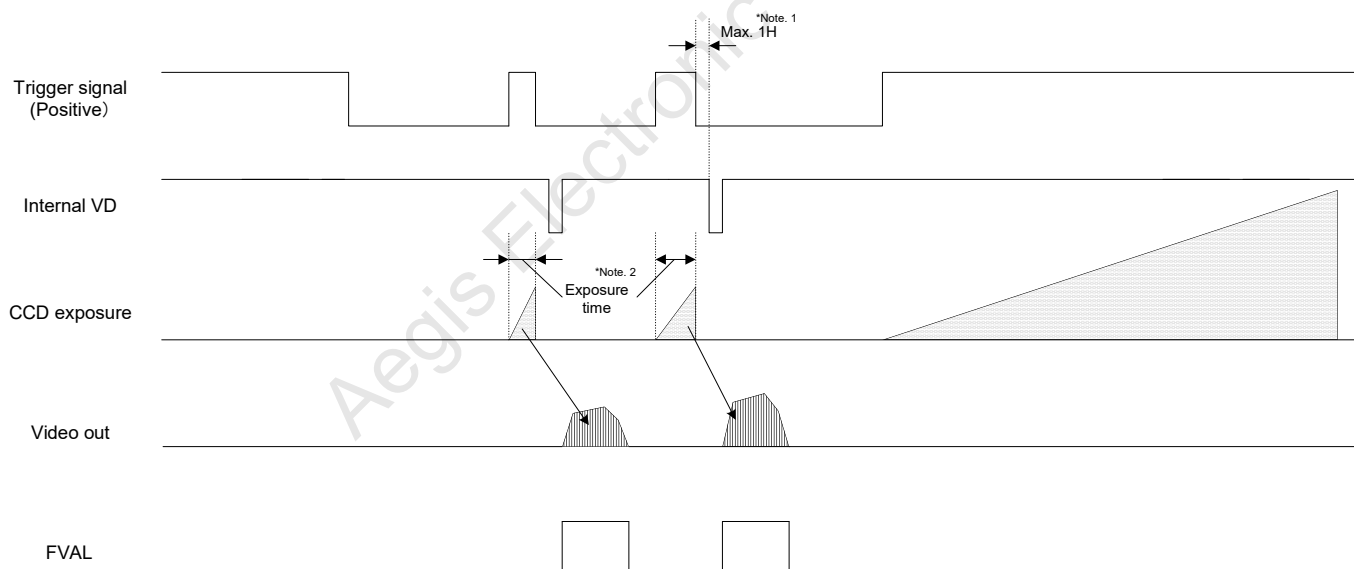

Note 1: The video output is going to be V reset by the next internal HD signal immediately after the exposure is finished. The exposure time is set by the pulse width of the trigger signal.

Note 2: The FVAL signal does not output when the exposure by the trigger signal does not exist.

3.2.2 Exposure Timing with the Positive Polarity Trigger Signal

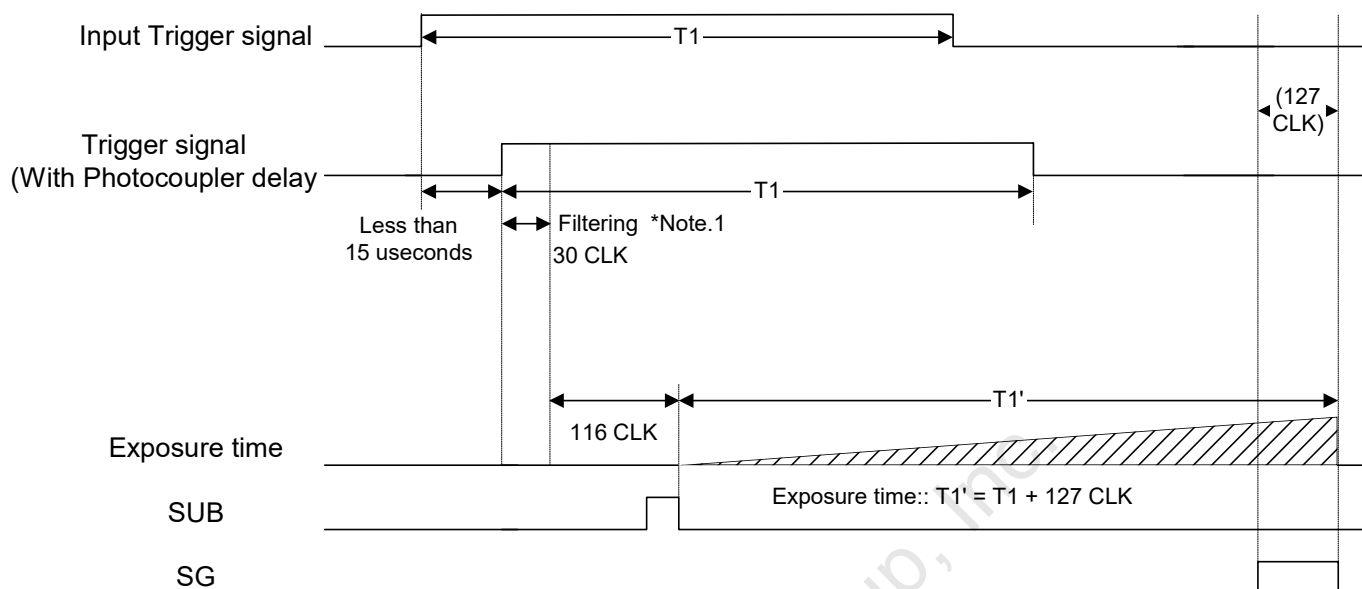

Note 1: The trigger signal will be removed by the filtering if the pulse width of the input trigger signal is less than 30 CLK. Please input a trigger signal with more than 31 CLK pulse width.

Note 2: The exposure will start 146 CLK after the rising edge of the trigger signal.

3.2.3 Exposure Timing with the Negative Polarity Trigger Signal

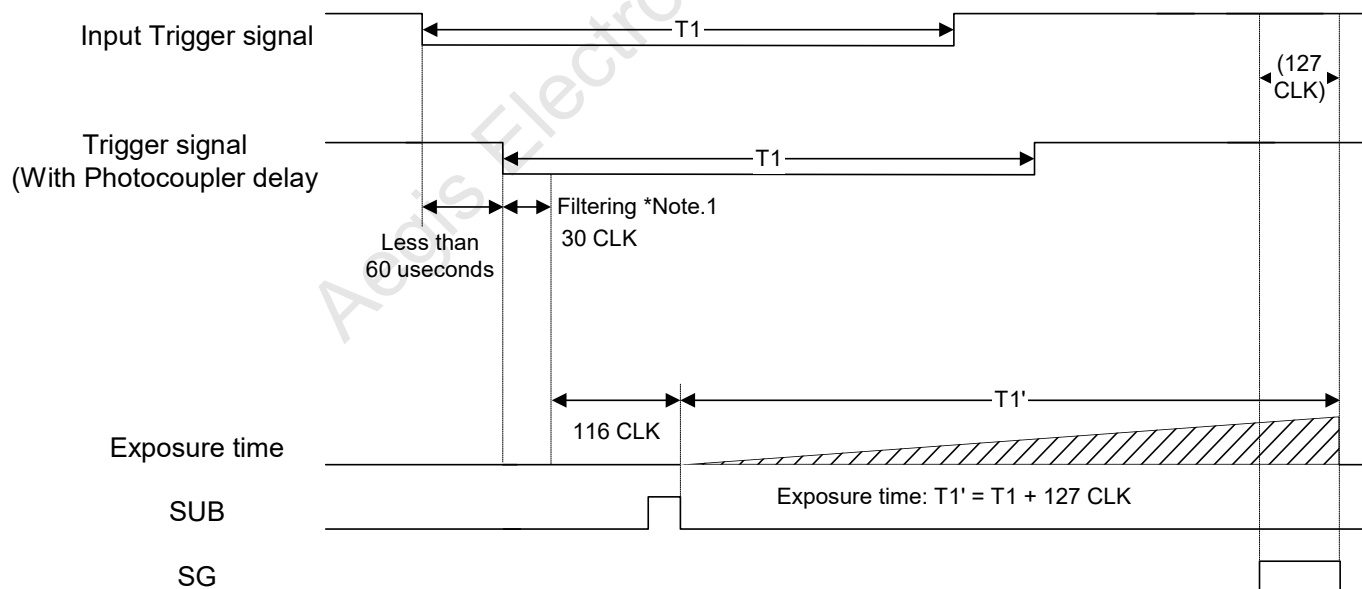

Note 1: The trigger signal will be removed by the filtering if the pulse width of the input trigger signal is less than 30 CLK. Please input a trigger signal with more than 31 CLK pulse width.

Note 2: The exposure will start 146 CLK after the rising edge of the trigger signal.

3.3 Edge Preset Trigger Mode

In this “edge preset trigger mode”, the camera exposure starts at the rising edge of the trigger signal like the “pulse width trigger mode” in the previous sections. However, in this mode, the exposure duration time is based on the preset value stored by the camera setting communication.

3.3.1 Timing

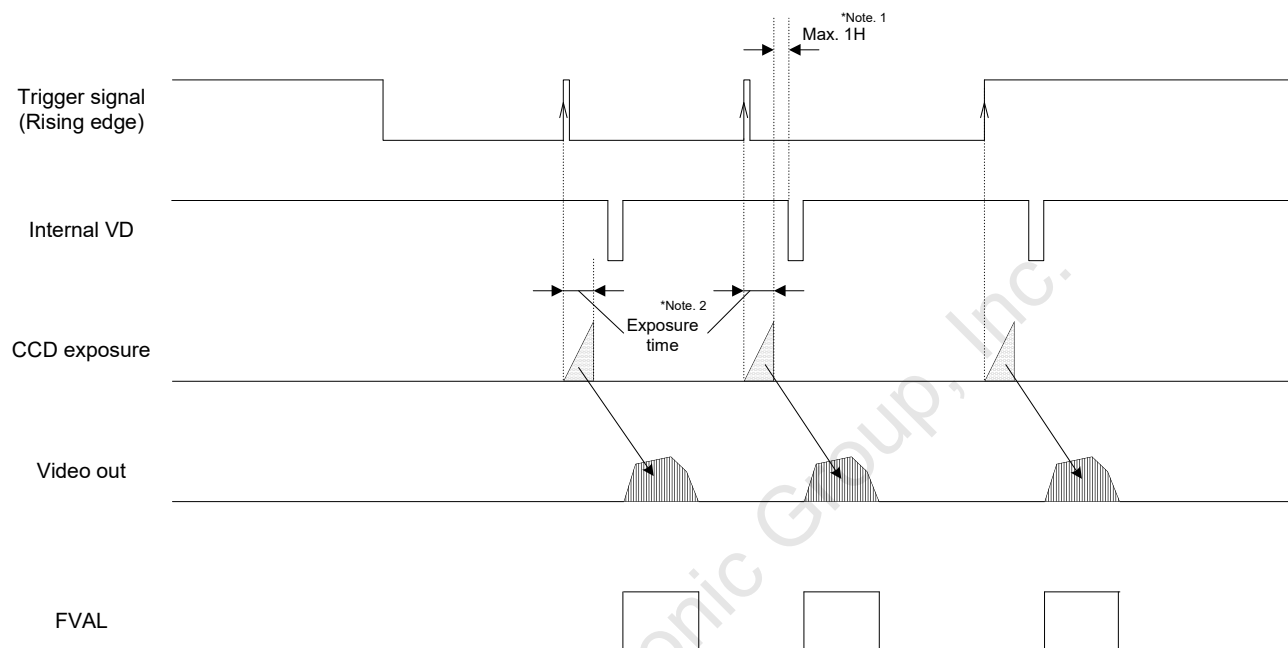

Note 1: The video output will be V reset by the next internal HD signal immediately after the exposure is finished.

Note 2: The exposure time is set by the preset electronic shutter speed.

3.3.2 Exposure Timing with the Positive Polarity Trigger Signal

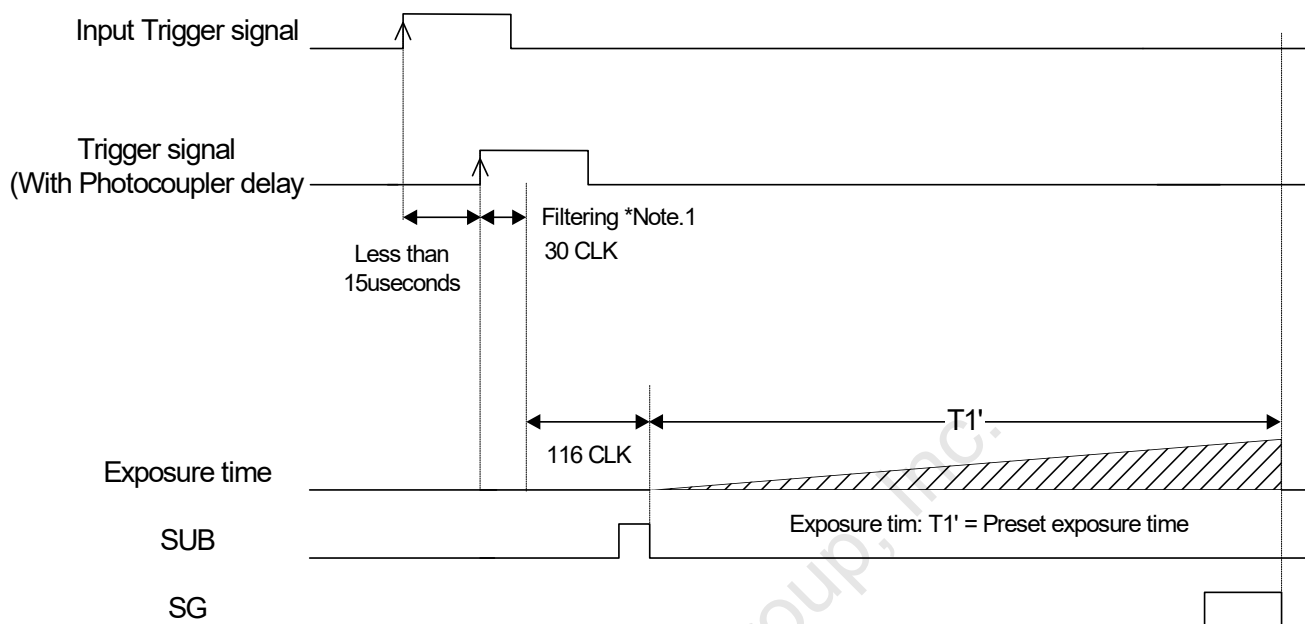

Note 1: The trigger signal will be removed by the filtering if the pulse width of the input trigger signal is less than 30 CLK. Please input a trigger signal with more than 31 CLK pulse width.

Note 2: The exposure will start 146 CLK after the rising edge of the trigger signal.

3.3.3 Exposure timing with the negative polarity trigger signal

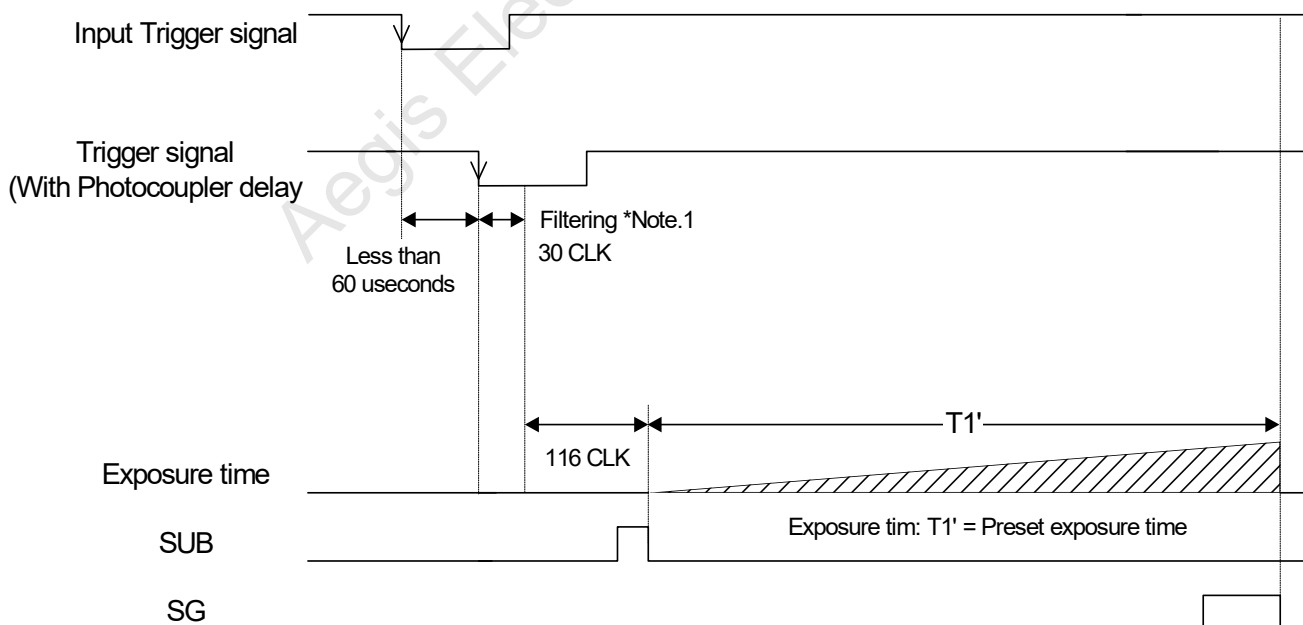

Note 1: The trigger signal will be removed by the filtering if the pulse width of the input trigger signal is less than 30 CLK. Please input a trigger signal with more than 31 CLK pulse width.

Note 2: The exposure will start 146 CLK after the rising edge of the trigger signal.

3.4 Edge Preset Trigger Mode (Trigger Input While the Image Is Out)

In this trigger mode, the camera exposure starts at the rising edge of the trigger pulse.

If trigger signal input is required while the image is out, then it is necessary to disable the trigger signal mask with the communication.

To avoid generating additional noise on the image, it is necessary to set the “H reset” at the exposure start mode.

3.4.1 Timing

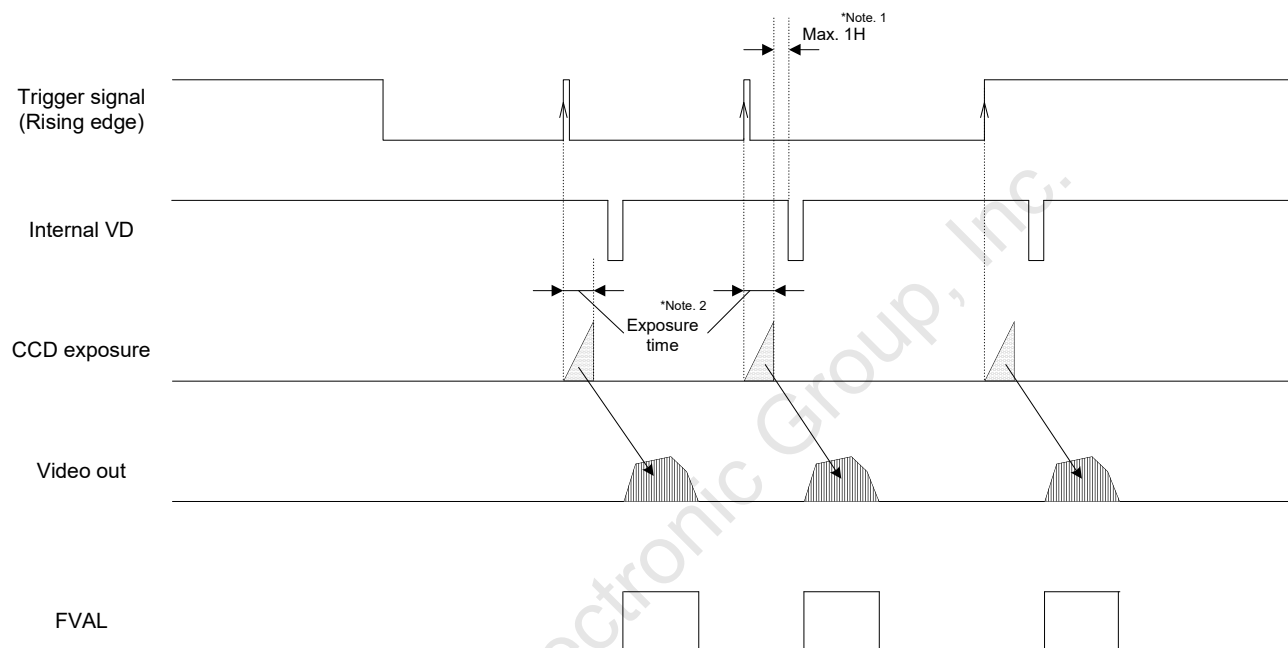

Note 1: The video output will be V reset by the next internal HD signal immediately after the exposure is finished.

Note 2: The exposure time is set by the preset electronic shutter speed.

3.4.2 Exposure Timing with the Positive Polarity Trigger Signal

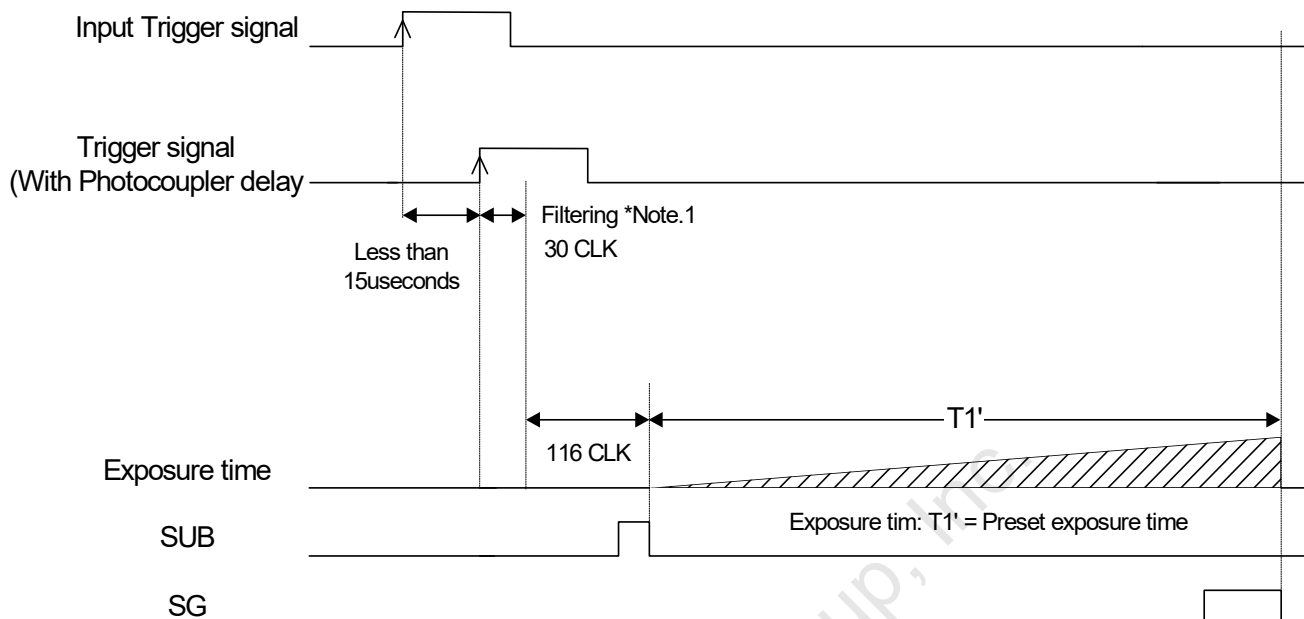

Note 1: The trigger signal will be removed by the filtering if the pulse width of the input trigger signal is less than 30 CLK. Please input a trigger signal with more than 31 CLK pulse width.

Note 2: The exposure will start 146 CLK after the rising edge of the trigger signal.

3.4.3 Exposure Timing with the Negative Polarity Trigger Signal

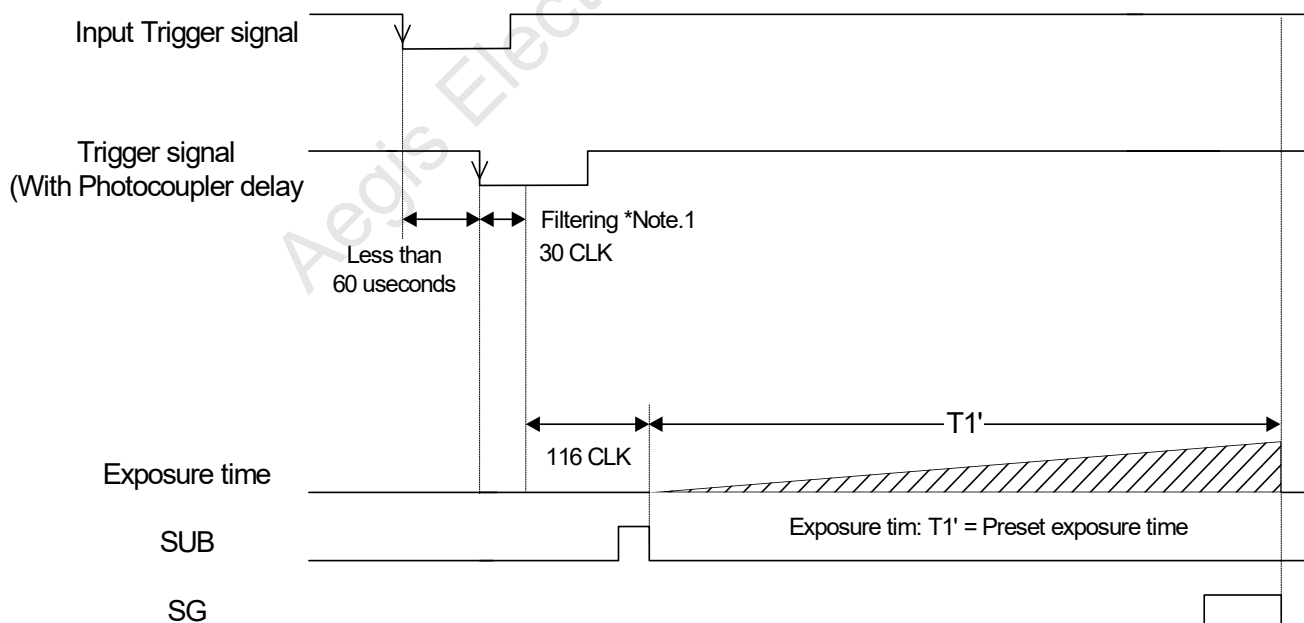

Note 1: The trigger signal will be removed by the filtering if the pulse width of the input trigger signal is less than 30 CLK. Please input a trigger signal with more than 31 CLK pulse width.

Note 2: The exposure will start 105 CLK after the rising edge of the trigger signal.

3.5 H Reset Mode

In this mode, the exposure can be start during the video is out from the camera without the horizontal noises. Therefore, generates the SUB pulse to sweep the charges during the horizontal blanking to prevent from getting horizontal noises.

The image is getting the horizontal noises caused by generates the SUB pulse during the video out in normal mode, which is this mode is OFF.

The maximum delay to start exposure from the trigger input is 1H.

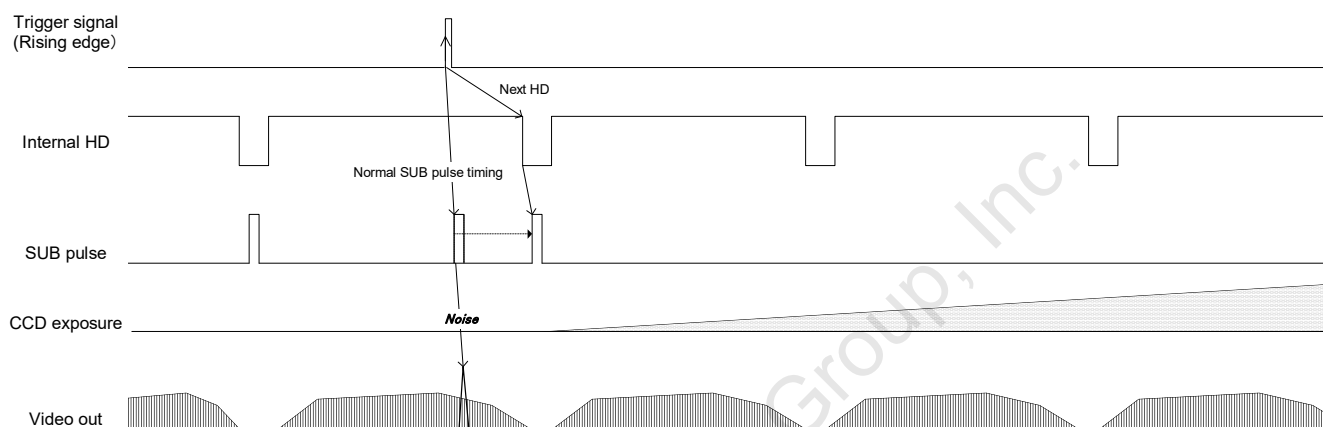

4 Communication Protocol

This camera has a communication function that enables external devices, such as a PC, to control the camera's functions.

Please use the "StCamGigEWare" or "StGigECtrl" communication software, or the following communication protocol to communicate to the camera:

4.1 Communication Method

UART (RS232C) ,binary communication

4.2 Communication Settings

	Settings
Baud Rate	115,200 bps
Data Bit	8 bit
Parity	None
Stop Bit	1 bit
Flow Control	None

4.3 Communication Format

The Sending data format from the PC to the camera is as follows:

SOF	Device Code	Read/Write	Page Selection	Command Code	Data Length	Data	EOF
(8bit)	(6bit)	(1bit)	(1bit)	(8bit)	(8bit)	(R: 1 byte) (W: n bytes)	(8bit)

The Receiving Data format from the camera is as follows:

- After sending the Read Command:

SOF	Data Length	Data	EOF
(8bit)	(8bit)	(n bytes)	(8bit)

- After sending the Write Command:

SOF	Data Length	Receiving Code	EOF
(8bit)	(8bit) "00"	(1 byte)	(8bit)

The description of the format is as follows.

Name	Descriptions
SOF	Start of Frame. Always set or receive the value as "02H"
Device Code	<p>This indicates the destination of communication.</p> <p>Set "000000" when accessing the camera's function settings Set "100000" when accessing the camera's extended function settings. Please refer to the "Camera Command List" and "Description of the Camera Control Commands".</p>
Read / Write	<p>This specifies "Read" or "Write" to command numbers.</p> <p>Set (or receive) "0" to send the read command. Set (or receive) "1" to send the write command.</p>
Page Selection	<p>This specifies page selection (access selection to registers or EEPROM) of command.</p> <p>Set "0" to access the command register of the camera. Read command: To obtain the current data from the command register. Write command: To set a data into the command register. <u>The previously stored data is replaced by this data. However, the data in the EEPROM is not replaced.</u></p> <p>Set "1" to access the EEPROM of the camera. Read command: To read stored data from the EEPROM. Write command: To store data into the EEPROM as default value. The camera returns the receiving code "01H" to the PC after storing data in the EEPROM.</p>
Command Code	This indicates the contents of the data sent or received. Refer to the following page for the details.
Data Length	<p>This indicates the data length (unit: byte).</p> <p>Receiving Frame: The data length is dependent on each read command sent. The data length is defined as "00H" when sending the write command. The data length of error response is defined as "00H".</p> <p>Sending frame: The data length is 1 byte dummy data when sending the read command, and that data is not referenced. The data length is dependent on each "write command" sent.</p>
Data	This indicates write data or read data according to command type.
EOF	End of Frame. Always set or receive the value as "03H"
Receiving Code	<p>This indicates results of the command sent</p> <p>01H: OK (ACK), 10H: NG (NAC), 12H: Command number error (Not matching), 13H: Communication frame error (only for Gamma data upload), 14H: Time out error (Two seconds), 15H: Check sum error (only for Gamma data upload), 16H: Data length error (Not matching), 17H: EEPROM write error</p>

【Example Code】 Reading the data from the command 00H

- Command to send: 02H, 00H, 00H, 01H, 00H, 03H

SOF	Device Code	Read/Write	Page Selection	Command Code	Data Length	Data	EOF
(8bit)	(6bit)	(1bit)	(1bit)	(8bit)	(8bit)	(1byte)	(8bit)
02H		00H		00H	01H	00H	03H

- Command to receive upon a successful communication: 02H, 01H, 00H, 03H (assuming the data is 00H)

SOF	Data Length	Data	EOF
(8bit)	(8bit)	(n bytes)	(8bit)
02H	01H	00H	03H

【Sequence for the saving commands to the EEPROM】

Please use the following sequence for saving the commands to the EEPROM.

- 1) Set "1" to the 80H.0 to enable writing to the EEPROM.
- 2) Send the save data with the page selection "1".
- 3) The camera sends back one of the following receiving codes after writing the EEPROM.
01H: OK
17H: EEPROM write error
- 4) 80.0H is cleared to "0" automatically after writing the EEPROM.

Note1: The data cannot be saved to the EEPROM when 80H.0 is "0".

Note2: When saving the consecutive sequence of commands, the above steps, 1) to 4), are necessary only once.

i.e.) saving the commands "10H, 11H, 12H, 13H", or "22H, 23H, 24H", etc.

Note3: When saving the non-consecutive sequence of commands, the above steps, 1) to 4), are necessary for the same number of times.

i.e.) saving the commands "10H, 13H, 19H, 1BH" or "20H, 23H, 25H", etc.

4.4 Camera Control Command

- The data unit of the each command is 1 byte (8bit).
- The data can be saved to the EEPROM if there is an “X” in the “Save to EEPROM” column in the following list.
- The camera initializes based on the stored data in the EEPROM when the power is applied.

4.4.1 Camera Command List (Device Code: 000000)

Device Code = 000000					
Command No.	R/W	Save to EEPROM	Function	Initial Data	Data Range
00 to 0FH			<i>Reserved</i>	-	-
10H	R/W	x	<i>camera function mode 1 (8bit: D[7..0])</i>	89H	
11H	R/W	x	<i>camera function mode 2 (8bit: D[7..0])</i>	0FH	
12H	R/W	x	<i>camera function mode 3 (8bit: D[7..0])</i>	00H	
13H	R/W	x	<i>camera function mode 4 (8bit: D[7..0])</i>	60H	
14 to 15H			<i>reserved</i>	-	-
16H	R/W	x	<i>software trigger mode (8bit: D[7..0])</i>	80H	
17H	R/W	x	<i>image data reset (8bit: D[7..0])</i>	00H	
18H			<i>reserved</i>	-	-
19H	R/W	x	<i>image output format (8bit: D[7..0])</i>	Mono:00H,Color:05H	
1A to 1FH			<i>reserved</i>	-	-
20H	R/W	x	<i>exposure time (us) of the electronic shutter (24bit: D[7..0])</i>	0	0,10 to 16,777,215
21H	R/W	x	<i>exposure time (us) of the electronic shutter (24bit: D[15..8])</i>		
22H	R/W	x	<i>exposure time (us) of the electronic shutter (24bit: D[24..16])</i>		
23 to 2FH			<i>reserved</i>	-	-
30H	R/W	x	<i>CDS gain (8bit: D[7..0])</i>	0	0 to 255
31H	R/W	x	<i>digital gain (8bit: D[7..0])</i>	factory adjusted value	-
32H	R/W	x	<i>gain offset (8bit: D[7..0])</i>		-
33 to 37H			<i>reserved</i>	-	-
38H	R/W	x	<i>Black level (8bit: D[7..0])</i>	9	0 to 31
39 to 3DH			<i>reserved</i>	-	-
3EH	R/W	x	<i>white clip for the test pattern (16bit: D[15..8])</i>	4,095	0 to 4,095
3FH	R/W	x	<i>white clip for the test pattern (16bit: D[7..0])</i>		
40 to 4FH			<i>reserved</i>	-	-
50H	R/W	x	<i>trigger delay time (us) (Integer) (24bit: D[7..0])</i>	0	0 to 2,000,000
51H	R/W	x	<i>trigger delay time (us) (Integer) (24bit: D[15..8])</i>		
52H	R/W	x	<i>trigger delay time (us) (Integer) (24bit: D[23..16])</i>		
53H	R/W	x	<i>trigger delay time (us) (Decimal) (8bit: D[7..0])</i>		
54H	R/W	x	<i>strobe signal delay time (us) (Integer) (24bit: D[7..0])</i>	0	0 to 2,000,000
55H	R/W	x	<i>strobe signal delay time (us) (Integer) (24bit: D[15..8])</i>		
56H	R/W	x	<i>strobe signal delay time (us) (Integer) (24bit: D[23..16])</i>		
57H	R/W	x	<i>strobe signal delay time (us) (Decimal) (8bit: D[7..0])</i>		

Device Code = 000000

Command No.	R/W	Save to EEPROM	Function	Initial Data	Data Range
58H	R/W	x	frame rate (Hz) (Integer) (16bit: D[7..0])	34.23358	0.55789 ~ 136.93433
59H	R/W	x	frame rate (Hz) (Integer) (16bit: D[15..8])		
5AH	R/W	x	frame rate (Hz) (Decimal) (24bit: D[7..0])		
5BH	R/W	x	frame rate (Hz) (Decimal) (24bit: D[15..8])		
5CH	R/W	x	frame rate (Hz) (Decimal) (24bit: D[23..16])		
5DH	R/W	x	I/O signal polarity (8bit: D[7..0])	00H	
5EF	R/W	x	gain base offset (16bit : D[7..0])	336	0 to 1,023
5FH	R/W	x	gain base offset (16bit : D[15..8])		
60 to 77H			reserved	-	-
78H	R/W	x	test pattern selection (8bit: D[7..0])	00H	
79H	R/W	x	image effect selection (8bit: D[7..0])	00H	
7A to 7FH			reserved	-	-
80H	R/W		EEPROM control (8bit: D[7..0])	00H	
81 to 8FH			reserved	-	-
90H	R/W	x	strobe signal active time (us) (Integer) (24bit: D[7..0])	10	0 to 2,000,000
91H	R/W	x	strobe signal active time (us) (Integer) (24bit: D[15..8])		
92H	R/W	x	strobe signal active time (us) (Integer) (24bit: D[23..16])		
93H	R/W	x	strobe signal active time (us) (Decimal) (8bit: D[7..0])		
94 to EFH			reserved	-	-
F0H	R/W	x	signals of the power-I/O connector (8bit: D[7..0])	20H	
F1H	R/W	x	user output signal for the power-I/O connector (8bit: D[7..0])	00H	
F2 to FFH			reserved	-	-

4.4.2 Camera Command List (Device Code: 100000)

Device Code = 100000					
Command No.	R/W	Save to EEPROM	Function	Initial Data	Data Range
00 to 1FH			<i>reserved</i>	-	-
20H	R/W	x	<i>exposure mode (8bit: D[7..0])</i>	00H	
21H	R/W	x	<i>AGC maximum limit (8bit: D[7..0])</i>	255	0 to 255
22H			<i>reserved</i>	-	-
23H	R/W	x	<i>upper limit of the auto electronic shutter (20bit: D[7..0])</i>	51,925	0 to 16,777,215
24H	R/W	x	<i>upper limit of the auto electronic shutter (20bit: D[15..8])</i>		
25H	R/W	x	<i>upper limit of the auto electronic shutter (20bit: D[20..16])</i>		
26H	R/W	x	<i>lower limit of the auto electronic shutter (20bit: D[7..0])</i>	1	0 to 16,777,215
27H	R/W	x	<i>lower limit of the auto electronic shutter (20bit: D[15..8])</i>		
28H	R/W	x	<i>lower limit of the auto electronic shutter (20bit: D[20..16])</i>		
29H	R/W	x	<i>weight1 for ALC (8bit: D[7..0])</i>	11H	D3 to D0: 0 to 15 D7 to D4: 0 to 15
2AH	R/W	x	<i>weight2 for ALC (8bit: D[7..0])</i>	11H	
2BH	R/W	x	<i>weight3 for ALC (8bit: D[7..0])</i>	1AH	
2CH	R/W	x	<i>weight4 for ALC (8bit: D[7..0])</i>	11H	
2DH	R/W	x	<i>weight5 for ALC (8bit: D[7..0])</i>	01H	D3 to D0: 0 to 15 D7 to D4: 0
2EH	R/W	x	<i>target brightness for ALC (8bit: D[7..0])</i>	128	0 to 255
2FH	R/W	x	<i>ALC peak-average (8bit: D[7..0])</i>	0	0 to 255
30H	R/W	x	<i>vertical_1 position for the ALC weight area (16bit: D[7..0])</i>	32	0 to 1,039
31H	R/W	x	<i>vertical_1 position for the ALC weight area (16bit: D[15..8])</i>		
32H	R/W	x	<i>vertical_2 position for the ALC weight area (16bit: D[7..0])</i>	378	0 to 1,039
33H	R/W	x	<i>vertical_2 position for the ALC weight area (16bit: D[15..8])</i>		
34H	R/W	x	<i>vertical_3 position for the ALC weight area (16bit: D[7..0])</i>	662	0 to 1,039
35H	R/W	x	<i>vertical_3 position for the ALC weight area (16bit: D[15..8])</i>		
36H	R/W	x	<i>vertical_4 position for the ALC weight area (16bit: D[7..0])</i>	1,008	0 to 1,039
37H	R/W	x	<i>vertical_4 position for the ALC weight area (16bit: D[15..8])</i>		
38H	R/W	x	<i>horizontal_1 position for the ALC weight area (16bit: D[7..0])</i>	36	0 to 1,359
39H	R/W	x	<i>horizontal_1 position for the ALC weight area (16bit: D[15..8])</i>		
3AH	R/W	x	<i>horizontal_2 position for the ALC weight area (16bit: D[7..0])</i>	489	0 to 1,359
3BH	R/W	x	<i>horizontal_2 position for the ALC weight area (16bit: D[15..8])</i>		
3CH	R/W	x	<i>horizontal_3 position for the ALC weight area (16bit: D[7..0])</i>	871	0 to 1,359
3DH	R/W	x	<i>horizontal_3 position for the ALC weight area (16bit: D[15..8])</i>		
3EH	R/W	x	<i>horizontal_4 position for the ALC weight area (16bit: D[7..0])</i>	1,324	0 to 1,359
3FH	R/W	x	<i>horizontal_4 position for the ALC weight area (16bit: D[15..8])</i>		
40H	R/W	x	<i>white balance mode (8bit: D[7..0])</i>	00H	
41H	R/W	x	<i>preset_1 white balance (Red gain) (8bit: D[7..0])</i>	0	0 to 255
42H	R/W	x	<i>preset_1 white balance (Gr gain) (8bit: D[7..0])</i>	0	0 to 255
43H	R/W	x	<i>preset_1 white balance (Blue gain) (8bit: D[7..0])</i>	0	0 to 255
44H	R/W	x	<i>preset_1 white balance (Gb gain) (8bit: D[7..0])</i>	0	0 to 255
45H	R/W	x	<i>preset_2 white balance (Red gain) (8bit: D[7..0])</i>	0	0 to 255
46H	R/W	x	<i>preset_2 white balance (Gr gain) (8bit: D[7..0])</i>	0	0 to 255
47H	R/W	x	<i>preset_2 white balance (Blue gain) (8bit: D[7..0])</i>	0	0 to 255
48H	R/W	x	<i>preset_2 white balance (Gb gain) (8bit: D[7..0])</i>	0	0 to 255

Device Code = 10000					
Command No.	R/W	Save to EEPROM	Function	Initial Data	Data Range
49H	R/W	x	<i>preset_3 white balance (Red gain) (8bit: D[7..0])</i>	0	0 to 255
4AH	R/W	x	<i>preset_3 white balance (Gr gain) (8bit: D[7..0])</i>	0	0 to 255
4BH	R/W	x	<i>preset_3 white balance (Blue gain) (8bit: D[7..0])</i>	0	0 to 255
4CH	R/W	x	<i>preset_3 white balance (Gb gain) (8bit: D[7..0])</i>	0	0 to 255
4DH			<i>reserved</i>	-	-
4EH	R/W	x	<i>threshold for auto white balance (16bit: D[7..0])</i>	3,072	0 to 4,095
4FH	R/W	x	<i>threshold for auto white balance (16bit: D[16..8])</i>		
50H	R/W	x	<i>Y_offset for AOI (8bit: D[7..0])</i>	0	2 ≤ Y ≤ 1,040, where Y = offset + height
51H	R/W	x	<i>Y_offset for AOI (16bit: D[15..8])</i>		
52H	R/W	x	<i>height for AOI (8bit: D[7..0])</i>	1,040	
53H	R/W	x	<i>height for AOI (16bit: D[15..8])</i>		
54H	R/W	x	<i>X_offset for AOI (8bit: D[7..0])</i>	0	8 ≤ X ≤ 1,360, where X = offset + width
55H	R/W	x	<i>X_offset for AOI (16bit: D[15..8])</i>		
56H	R/W	x	<i>width for AOI (8bit: D[7..0])</i>	1,360	
57H	R/W	x	<i>width for AOI (16bit: D[15..8])</i>		
58H	R/W	x	<i>vertical_1 position for the white balance area (16bit: D[7..0])</i>	0	0 to 1,039
59H	R/W	x	<i>vertical_1 position for the white balance area (16bit: D[15..8])</i>		
5AH	R/W	x	<i>vertical_2 position for the white balance area (16bit: D[7..0])</i>	1,039	0 to 1,039
5BH	R/W	x	<i>vertical_2 position for the white balance area (16bit: D[15..8])</i>		
5CH	R/W	x	<i>horizontal_1 position for the white balance area (16bit: D[7..0])</i>	0	0 to 1,539
5DH	R/W	x	<i>horizontal_1 position for the white balance area (16bit: D[15..8])</i>		
5EH	R/W	x	<i>horizontal_2 position for the white balance area (16bit: D[7..0])</i>	1,539	0 to 1,539
5FH	R/W	x	<i>horizontal_2 position for the white balance area (16bit: D[15..8])</i>		
60H	R/W	x	<i>camera mode1 (8bit: D[7..0])</i>	00H	
61 to 7FH			<i>reserved</i>	-	-
80H	R/W	x	<i>push set white balance (Red gain) (8bit: D[7..0])</i>	0	0 to 255
81H	R/W	x	<i>push set white balance (Gr gain) (8bit: D[7..0])</i>	0	0 to 255
82H	R/W	x	<i>push set white balance (Blue gain) (8bit: D[7..0])</i>	0	0 to 255
83H	R/W	x	<i>push set white balance (Gb gain) (8bit: D[7..0])</i>	0	0 to 255
84 to 90H			<i>reserved</i>	-	-
91H			<i>reserved</i>	-	-
92H	R/W	x	<i>iris lens manual adjustment (8bit: D[7..0])</i>	01H	
93 to FFH			<i>reserved</i>	-	-

4.4.3 Descriptions of the Camera Commands (Device code: 000000); (The underline settings are the factory default settings)

Command No.	Command Description								
10H: MOD1[7..0]	<p>[camera function mode 1] Initial data: MOD1[7..0] = 89H Sets the camera function mode.</p> <p>D[7..0]</p> <table border="1"> <tr> <td>D7</td><td>D6</td><td>D5</td><td>D4</td><td>D3</td><td>D2</td><td>D1</td><td>D0</td> </tr> </table> <p>D7: No Function <u>Always set as "1"</u></p> <p>D6: Trigger Polarity <u>0: Positive</u> 1: Negative</p> <p>D5: Trigger Mode <u>0: Edge Preset</u> 1: Pulse Width</p> <p>D4: Binning Mode <u>0: OFF (Normal)</u> 1: ON (Binning)</p> <p>D3 to D0: No Function <u>Always set as "1001"</u></p> <p>Note 1: The trigger polarity is automatically set to positive when using the software trigger; the trigger polarity cannot be changed.</p>	D7	D6	D5	D4	D3	D2	D1	D0
D7	D6	D5	D4	D3	D2	D1	D0		
11H: MOD2[7..0]	<p>[Camera function mode 2] Initial data: MOD2[7..0] = 0FH Sets the camera function mode.</p> <p>D[7..0]</p> <table border="1"> <tr> <td>D7</td><td>D6</td><td>D5</td><td>D4</td><td>D3</td><td>D2</td><td>D1</td><td>D0</td> </tr> </table> <p>D7 to D5: No Function <u>Always set as "000"</u></p> <p>D4: Smear Half Reduction <u>0: OFF</u> 1: ON</p> <p>D3: Operational Mode <u>0: Trigger Mode</u> 1: <u>Continuous Mode</u></p> <p>D2 to D0: No Function <u>Always set as "111"</u></p> <p>Note 1: The function mode is enabled whenever the "Continuous/Trigger mode (MOD1-D7)" is manual. Note 2: While the camera is in Trigger Mode, the video will not output without the trigger signal input.</p>	D7	D6	D5	D4	D3	D2	D1	D0
D7	D6	D5	D4	D3	D2	D1	D0		
12H: MOD3[7..0]	<p>[Camera function mode 3] Initial data: MOD3[7..0] = 00H Sets the camera function mode.</p> <p>D[7..0]</p> <table border="1"> <tr> <td>D7</td><td>D6</td><td>D5</td><td>D4</td><td>D3</td><td>D2</td><td>D1</td><td>D0</td> </tr> </table> <p>D7 to D6: No Function <u>Always set as "00"</u></p> <p>D5: Trigger Signal Type <u>0: Software Trigger</u> 1: Hardware Trigger (from No.5 pin of Power-I/O connector)</p> <p>D4 to D3: Exposure Start Mode <u>00: Normal</u> 10 to 11: H Reset 01: No Function (Prohibited setting. Do not set these values)</p> <p>D2 to D0: No Function <u>Always set as "000"</u></p> <p>Note 1: The trigger polarity is automatically set to positive when using the software trigger; the trigger polarity cannot be changed.</p>	D7	D6	D5	D4	D3	D2	D1	D0
D7	D6	D5	D4	D3	D2	D1	D0		
13H: MOD4[7..0]	<p>[Camera function mode 4] Initial data: MOD4[7..0] = 60H Sets the camera function mode.</p> <p>D[7..0]</p> <table border="1"> <tr> <td>D7</td><td>D6</td><td>D5</td><td>D4</td><td>D3</td><td>D2</td><td>D1</td><td>D0</td> </tr> </table> <p>D7: No Function <u>Always set as "0"</u></p> <p>D6: Trigger signal mask during exposure <u>0: OFF (No mask)</u> 1: <u>ON (Mask)</u></p> <p>D5: Trigger signal mask during image output <u>0: OFF (No mask)</u> 1: <u>ON (Mask)</u></p> <p>D4 to D0: No Function <u>Always set as "100000"</u></p> <p>Note 1: The trigger signal is invalidated when mask function is on.</p>	D7	D6	D5	D4	D3	D2	D1	D0
D7	D6	D5	D4	D3	D2	D1	D0		

Command No.	Command Description								
16H: SOFTRG[7..0]	<p>[Software Trigger Setting] Initial data: SOFTRG[7..0] = 80H Sets the source of the software trigger.</p> <p>D[7..0]</p> <table border="1"> <tr> <td>D7</td><td>D6</td><td>D5</td><td>D4</td><td>D3</td><td>D2</td><td>D1</td><td>D0</td> </tr> </table> <p>D7 to D6: Software trigger source selection 00: Programming software trigger <u>10: Command software trigger</u> (200 useconds pulse width trigger signal) 01, 11: No function (Prohibited settings. Do not set these values)</p> <p>D5 to D1: No Function <u>Always set as "00000"</u></p> <p>D0: Generate software trigger command <u>0: Hold (Low State)</u> 1: Generate command software trigger (200 useconds high state)</p> <p>Note 1: The software trigger source selection is enabled whenever "Trigger signal type (MOD3-D5)" is the software trigger (set as 0) Note 2: The "Programming software trigger" is used to set up the pulse duration, trigger signal interval and generate the trigger signal. Note 3: When selecting "Command software trigger", it is necessary to generate the software trigger signal with the "Generate command software trigger (SOFTRIG-D0)".</p>	D7	D6	D5	D4	D3	D2	D1	D0
D7	D6	D5	D4	D3	D2	D1	D0		
17H: IMAGEREST [7..0]	<p>[Image Data Reset] Initial data: IMAGEREST[7..0] = 00H Reset the Image data (FVAL, LVAL and the image data). Change from the reset to the image data out after starting the image acquisition. The image data is not output when resetting the image data.</p> <p>D[7..0]</p> <table border="1"> <tr> <td>D7</td><td>D6</td><td>D5</td><td>D4</td><td>D3</td><td>D2</td><td>D1</td><td>D0</td> </tr> </table> <p>D7 to D1: No Function <u>Always set as "0000000"</u></p> <p>D0: Image Data Reset <u>0: FVAL/LVAL/Image data reset</u> (FVAL, LVAL and the image data are low state data) 1: FVAL/LVAL/Image data out</p>	D7	D6	D5	D4	D3	D2	D1	D0
D7	D6	D5	D4	D3	D2	D1	D0		
19H FORMAT[7..0]	<p>[Image output format] initial data: Monochrome FORMAT[7..0] = 00H, Color = 05H Sets the output format of the image data.</p> <p>D[7..0]</p> <table border="1"> <tr> <td>D7</td><td>D6</td><td>D5</td><td>D4</td><td>D3</td><td>D2</td><td>D1</td><td>D0</td> </tr> </table> <p>D7 to D4: No Function <u>Always set as "0000"</u></p> <p>D2 to D0: Output format 000: Mono8 0101: BayerGR8 001: Mono10 0110: BayerGR10 010: Mono10Packed 0111: BayerGR12 011: Mono12 1000: BayerGR10Packed 100: Mono12Packed 1001: BayerGR12Packed 1010: RGB8Packed 1011 to 1111: No function (Prohibited setting. Do not set these values)</p>	D7	D6	D5	D4	D3	D2	D1	D0
D7	D6	D5	D4	D3	D2	D1	D0		
20H: EXPTM[7..0] 21H: EXPTM[15..8] 22H: EXPTM[23..16]	<p>[Exposure time (useconds) of the electronic shutter] Initial data: EXPTM[23..0] = 0, data range: 0, 10 to 16,777,215 Sets the exposure time for the electronic shutter.</p> <p>Exposure time = EXPTM[23..0] useconds</p> <p>When set as 0, the electronic shutter is OFF.</p>								

Command No.	Command Description
30H: PGA[7..0]	<p>[CDS gain] Initial data: PGA [7..0] = 0, data range: 0 to 255 Sets the CDS gain (programmable gain)</p> <p>CDS gain = $7.44 + 0.04 \times (\text{PGA}[7..0] \times 2 + \text{GOFs}[7..0])\text{dB}$</p> <p>*GOFs[7..0]: The gain offset (The value of the address 32H)</p>
31H: DGB[7..0]	<p>[Digital gain] Initial data: DGB [7..0] = The factory adjusted value</p> <p>Video level = $(\text{Input video level} - \text{BLACK level}) \times (1 + \text{DGB}[7..0]/128) + \text{BLACK Level}$</p> <p>*BLACK Level Black level (The calculated value of the address 38H)</p>
32H: GOFs[7..0]	<p>[Gain offset] Initial data: GOFs[7..0] = The factory adjusted value, data range: 0 to 255</p>
38H: BLACK[7..0]	<p>[Black level] Initial data: BLACK[7..0] = 9; data range: 0 to 31 Sets the Black level (The Black level of the black signal)</p> <p>Black level = $\text{BLACK}[7..0] \times 8 + 56$ (for 12bit output) Black level = $(\text{BLACK}[7..0] \times 8 + 56) / 4$ (for 10bit output) Black level = $(\text{BLACK}[7..0] \times 8 + 56) / 16$ (for 8 bit output)</p> <p>Whenever it is set greater than 31, it will automatically resets to 31.</p>

Command No.	Command Description								
3EH: WHITE_CLIP[15..8] 3FH: WHITE_CLIP[7..0]	[White clip level for the white clip test pattern] Initial data: WHITE_CLIP[15..0] = 4,095; data range: 0 to 4,095 Sets the white clip level of the white clip test pattern.								
50H: DELAY_I[7..0] 51H: DELAY_I[15..8] 52H: DELAY_I[23..16] 53H: DELAY_F[7..0]	[Delay time (us) for the trigger signal] Initial data: DELAY_I[23..0] = 0, DELAY_F[7..0] = 0, data range: 0 to 2,000,000 Sets the delay time that is from the trigger signal input to the start of the exposure as useconds. Delay time for the trigger signal = (DELAY_I[23..0]). (DELAY_F[7..0]) useconds								
54H: STROBEDELAY_I[7..0] 55H: STROBEDELAY_I[15..8] 56H: STROBEDELAY_I[23..16] 57H: STROBEDELAY_F[7..0]	[Delay time (us) for the strobe signal] Initial data: STROBEDELAY_I[23..0] = 0, STROBEDELAY_F[7..0] = 0, data range: 0 to 2,000,000 Delay time for the strobe signal = (STROBEDELAY_I[23..0]). (STROBEDELAY_F[7..0]) useconds								
58H: FPS_I[7..0] 59H: FPS_I[15..8] 5AH: FPS_F[7..0] 5BH: FPS_F[15..8] 5CH: FPS_F[23..16]	[Frame rate (Hz)] Initial data: FPS_I[15..0] = 19, data range: 0 to 77 Initial data: FPS_F[15..0] = 25,954, data range: 0 to 99,999 Sets the frame rate as Hz Frame rate = (FPS_I[15..0]). (FPS_F[23..0]) Hz data range of frame rate: 0.55789 to 136.93433 Hz Maximum frame rate for full resolution: 34.23358 Hz (as initial data) Note 1: The maximum frame rate depends on the AOI setting Note 2: The maximum frame rate is achieved when the vertical resolution is set 1/4 of the full resolution. The maximum frame rate does not increase even if the vertical resolution is set smaller than 1/4 of the full resolution.								
5DH: IOSIGNAL_POL[7..0]	[I/O signal polarity] Initial data: IOSIGNAL_POL[7..0] = 00H, Sets the No.2 pin and No.3 pin of the I/O signal polarity. D[7..0] <table border="1" style="width: 100%; text-align: center;"> <tr> <td>D7</td><td>D6</td><td>D5</td><td>D4</td><td>D3</td><td>D2</td><td>D1</td><td>D0</td> </tr> </table> D7 to D2: No Function Always set as "000000" D1: No.3 pin (I/O-2) polarity 0: Non-invert 1: Invert D0: No.2 pin (I/O-1) polarity 0: Non-invert 1: Invert	D7	D6	D5	D4	D3	D2	D1	D0
D7	D6	D5	D4	D3	D2	D1	D0		
5EH: CDS_BASEGAIN[7..0] 5FH: CDS_BASEGAIN[15..8]	[CDS Base Gain] Initial data: CDS_BASEGAIN[15..0] = 336, data range: 0 to 1023 When the result of the below equation exceeds 1023, 1023 will be set CDS_BASEGAIN[15..0] + PGA[7..0] x 2 + GOFS[7..0] *PGA[7.0]: The CDS gain (The value of the address 30H) *GOFS[7.0]: The gain offset (The value of the address 32H)								
78H: TESTP[7..0]	[Test pattern selection] Initial data: TESTP[7..0] = 00H Sets the test pattern output from the camera. D[7..0] <table border="1" style="width: 100%; text-align: center;"> <tr> <td>D7</td><td>D6</td><td>D5</td><td>D4</td><td>D3</td><td>D2</td><td>D1</td><td>D0</td> </tr> </table> D7 to D0: 00H: Video output 01H: Gray scale 02H: Ramp wave 03H: 100% white 04H: White clip 05H: Color bar (RGB Bayer) Others: Black	D7	D6	D5	D4	D3	D2	D1	D0
D7	D6	D5	D4	D3	D2	D1	D0		

Command No.	Command Description								
79H: EFFCT[7..0]	<p>[Image effect selection] Initial data: EFFCT[7..0] = 00H Sets the image effect.</p> <p>D[7..0]</p> <table border="1"> <tr> <td>D7</td><td>D6</td><td>D5</td><td>D4</td><td>D3</td><td>D2</td><td>D1</td><td>D0</td> </tr> </table> <p>D7: Negative / Positive video selection <u>0: Positive image</u> 1: Negative image D6 to D0: Image effect <u>00H: No effect (Original)</u> 01H: 9bit gradation 02H: 9bit gradation 03H: 7bit gradation 04H: 6bit gradation 05H: 5bit gradation 06H: 4bit gradation 07H: 3bit gradation 08H: 2bit gradation 09H: 1bit gradation 0A to 7FH: No function (Prohibited settings. Do not set these values)</p>	D7	D6	D5	D4	D3	D2	D1	D0
D7	D6	D5	D4	D3	D2	D1	D0		
80H: E2P[7..0]	<p>[EEPROM control] Initial data: E2P[7..0] = 00H D[7..0]</p> <table border="1"> <tr> <td>D7</td><td>D6</td><td>D5</td><td>D4</td><td>D3</td><td>D2</td><td>D1</td><td>D0</td> </tr> </table> <p>D7 to D1: No function <u>Always set as "0000000"</u> D6 to D0: Write control to the EEPROM <u>0: Prohibited</u> 1: Accept</p> <p>Note: This bit is cleared to "0" automatically by the internal processes after the execution of the command.</p>	D7	D6	D5	D4	D3	D2	D1	D0
D7	D6	D5	D4	D3	D2	D1	D0		
90H: STROBEON_I[7..0] 91H: STROBEON_I[15..8] 92H: STROBEON_I[23..16] 93H: STROBEON_F[7..0]	<p>[Active time (us) for the strobe signal] Initial data: STROBEON_I[23..0] = 10, STROBEDELAY_F[7..0] = 0, data range: 0 to 2,000,000</p> <p>Active time for the strobe signal = (STROBEON_I[23..0]). (STROBEON_F[7..0]) useconds</p> <p>Active time for the strobe signal is set as below. 0: No strobe signal output 1 to 9: 10 us Greater than 9: set value</p>								
F0H: OUTSEL [7..0]	<p>[Output signal selection for the power-I/O connector] Initial data: OUTSEL[7..0] = 20H Sets the output signal from the power/I/O connector. D[7..0]</p> <table border="1"> <tr> <td>D7</td><td>D6</td><td>D5</td><td>D4</td><td>D3</td><td>D2</td><td>D1</td><td>D0</td> </tr> </table> <p>D7 to D4: Output signal for 3pin of the power/I/O connector 0: FrameTriggerWait signal 1: UserOutput signal 2: <u>ExposureActive signal</u> 3: TriggerAuxiliary signal 4: TriggerInternal signal (after mask and delay process) 5: SensorReadOut signal 6 to F: No Function (Prohibited setting. Do not set these values)</p> <p>D3 to D0: Output signal for 2pin of the power/I/O connector 0: <u>FrameTriggerWait signal</u> 1: UserOutput signal 2: ExposureActive signal 3: TriggerAuxiliary signal 4: TriggerInternal signal (after mask and delay process) 5: SensorReadOut signal 6 to F: No Function (Prohibited setting. Do not set these values)</p> <p>Note: When "UserOutput signal" is selected, set the status of the signal with "UserOutput signal for the power/I/O connector (TEST2-D3,4)".</p>	D7	D6	D5	D4	D3	D2	D1	D0
D7	D6	D5	D4	D3	D2	D1	D0		



4.4.4 Descriptions of the Camera Commands (Device code: 100000); (The underline settings are the factory default settings)

Command No.	Command Description								
20H: [7..0]	<p>[Exposure mode] Initial data: 00H Sets the exposure mode, which is the AGC, the shutter mode and the iris lens control method. D[7..0]</p> <table border="1"> <tr> <td>D7</td><td>D6</td><td>D5</td><td>D4</td><td>D3</td><td>D2</td><td>D1</td><td>D0</td> </tr> </table> <p>D7 to D4: No Function <u>Always set as "0000"</u></p> <p>D3: AGC <u>0: OFF (Fixed gain)</u> 1: ON (AGC)</p> <p>D2: Shutter Mode <u>0: OFF (Fixed shutter)</u> 1: ON (Auto shutter)</p> <p>D1: No Function <u>Always set as "0"</u></p> <p>D0: No Function <u>Always set as "0"</u></p>	D7	D6	D5	D4	D3	D2	D1	D0
D7	D6	D5	D4	D3	D2	D1	D0		
21H: [7..0]	<p>[AGC maximum limit] Initial data: 255, data range: 0 to 255 Sets the maximum limit for the AGC.</p>								
23H: [7..0] 24H: [15..8] 25H: [20..16]	<p>[Upper limit of the electronic shutter for auto shutter] Initial data: 54,925; data range: 0 to 16,777,215 Sets the upper limit of the electronic shutter for the auto shutter as usecond.</p>								
26H: [7..0] 27H: [15..8] 28H: [20..16]	<p>[Lower limit of the electronic shutter for auto shutter] Initial data: 1; data range: 0 to 16,777,215 Sets the upper limit of the electronic shutter for the auto shutter as usecond.</p>								
29H: [7..0]	<p>[Weight1 for ALC] Initial data: 11H Sets the weight for ALC weight area 1 and 2. D[7..0]</p> <table border="1"> <tr> <td>D7</td><td>D6</td><td>D5</td><td>D4</td><td>D3</td><td>D2</td><td>D1</td><td>D0</td> </tr> </table> <p>D7 to D4: Weight for ALC weight area 2 <u>1</u> Range: 0 to 15</p> <p>D3 to D0: Weight for ALC weight area 1 <u>1</u> Range: 0 to 15</p> <p>*Please set the ALC weight area with "30H to 3FH"</p>	D7	D6	D5	D4	D3	D2	D1	D0
D7	D6	D5	D4	D3	D2	D1	D0		
2AH: [7..0]	<p>[Weight2 for ALC] Initial data: 11H Sets the weight for ALC weight area 3 and 4. D[7..0]</p> <table border="1"> <tr> <td>D7</td><td>D6</td><td>D5</td><td>D4</td><td>D3</td><td>D2</td><td>D1</td><td>D0</td> </tr> </table> <p>D7 to D4: Weight for ALC weight area 4 <u>1</u> Range: 0 to 15</p> <p>D3 to D0: Weight for ALC weight area 3 <u>1</u> Range: 0 to 15</p> <p>*Please set the ALC weight area with "30H to 3FH"</p>	D7	D6	D5	D4	D3	D2	D1	D0
D7	D6	D5	D4	D3	D2	D1	D0		
2BH: [7..0]	<p>[Weight3 for ALC] Initial data: 1AH Sets the weight for ALC weight area 5 and 6. D[7..0]</p> <table border="1"> <tr> <td>D7</td><td>D6</td><td>D5</td><td>D4</td><td>D3</td><td>D2</td><td>D1</td><td>D0</td> </tr> </table> <p>D7 to D4: Weight for ALC weight area 6 <u>1</u> Range: 0 to 15</p> <p>D3 to D0: Weight for ALC weight area 5 <u>10</u> Range: 0 to 15</p> <p>*Please set the ALC weight area with "30H to 3FH"</p>	D7	D6	D5	D4	D3	D2	D1	D0
D7	D6	D5	D4	D3	D2	D1	D0		
2CH: [7..0]	<p>[Weight4 for ALC] Initial data: 11H Sets the weight for ALC weight area 7 and 8. D[7..0]</p> <table border="1"> <tr> <td>D7</td><td>D6</td><td>D5</td><td>D4</td><td>D3</td><td>D2</td><td>D1</td><td>D0</td> </tr> </table> <p>D7 to D4: Weight for ALC weight area 8 <u>1</u> Range: 0 to 15</p> <p>D3 to D0: Weight for ALC weight area 7 <u>1</u> Range: 0 to 15</p> <p>*Please set the ALC weight area with "30H to 3FH"</p>	D7	D6	D5	D4	D3	D2	D1	D0
D7	D6	D5	D4	D3	D2	D1	D0		

Command No.	Command Description								
2DH: [7..0]	<p>[Weight5 for ALC] Initial data: 01H Sets the weight for ALC weight area 9. D[7..0]</p> <table border="1" data-bbox="293 360 879 394"> <tr> <td>D7</td><td>D6</td><td>D5</td><td>D4</td><td>D3</td><td>D2</td><td>D1</td><td>D0</td> </tr> </table> <p>D7 to D4: No Function <u>Always set as "0000"</u> D3 to D0: Weight for ALC weight area 9 1 Range: 0 to 15</p> <p>*Please set the ALC weight area with "30H to 3FH"</p>	D7	D6	D5	D4	D3	D2	D1	D0
D7	D6	D5	D4	D3	D2	D1	D0		
2EH: [7..0]	<p>[Target Brightness for ALC] Initial data: 128, data range: 0 to 255 Sets the target brightness for the ALC function (AGC, auto shutter).</p>								
2FH: [7..0]	<p>[ALC peak-average] Initial data: 0, data range: 0 to 255 Sets the control standard for the ALC function (AGC, auto shutter)</p> <p>When set as 0 (Average: 100%, Peak: 0%), the ALC function with the average brightness of the photometry area.</p> <p>When set as 255 (Average: 0%, Peak: 100%), the ALC function with the peak brightness of the photometry area.</p>								

Command No.	Command Description										
30H: [7..0] 31H: [15..8]	[Vertical_1 position for the ALC weight area] Initial data: 32, data range: 0 to 1,039 Sets the vertical 1 position for the ALC weight area.	<table border="1"> <tr><td>1</td><td>2</td><td>3</td></tr> <tr><td>4</td><td>5</td><td>6</td></tr> <tr><td>7</td><td>8</td><td>9</td></tr> </table>	1	2	3	4	5	6	7	8	9
1	2	3									
4	5	6									
7	8	9									
32H: [7..0] 33H: [15..8]	[Vertical_2 position for the ALC weight area] Initial data: 378, data range: 0 to 1,039 Sets the vertical 2 position for the ALC weight area.	<table border="1"> <tr><td>1</td><td>2</td><td>3</td></tr> <tr><td>4</td><td>5</td><td>6</td></tr> <tr><td>7</td><td>8</td><td>9</td></tr> </table>	1	2	3	4	5	6	7	8	9
1	2	3									
4	5	6									
7	8	9									
34H: [7..0] 35H: [15..8]	[Vertical_3 position for the ALC weight area] Initial data: 662, data range: 0 to 1,039 Sets the vertical 3 position for the ALC weight area.	<table border="1"> <tr><td>1</td><td>2</td><td>3</td></tr> <tr><td>4</td><td>5</td><td>6</td></tr> <tr><td>7</td><td>8</td><td>9</td></tr> </table>	1	2	3	4	5	6	7	8	9
1	2	3									
4	5	6									
7	8	9									
36H: [7..0] 37H: [15..8]	[Vertical_4 position for the ALC weight area] Initial data: 1,008, data range: 0 to 1,039 Sets the vertical 4 position for the ALC weight area.	<table border="1"> <tr><td>1</td><td>2</td><td>3</td></tr> <tr><td>4</td><td>5</td><td>6</td></tr> <tr><td>7</td><td>8</td><td>9</td></tr> </table>	1	2	3	4	5	6	7	8	9
1	2	3									
4	5	6									
7	8	9									
38H: [7..0] 39H: [15..8]	[Horizontal_1 position for the ALC weight area] Initial data: 36, data range: 0 to 1,359 Sets the horizontal 1 position for the ALC weight area.	<table border="1"> <tr><td>1</td><td>2</td><td>3</td></tr> <tr><td>4</td><td>5</td><td>6</td></tr> <tr><td>7</td><td>8</td><td>9</td></tr> </table>	1	2	3	4	5	6	7	8	9
1	2	3									
4	5	6									
7	8	9									
3AH: [7..0] 3BH: [15..8]	[Horizontal_2 position for the ALC weight area] Initial data: 489, data range: 0 to 1,359 Sets the horizontal 2 position for the ALC weight area.	<table border="1"> <tr><td>1</td><td>2</td><td>3</td></tr> <tr><td>4</td><td>5</td><td>6</td></tr> <tr><td>7</td><td>8</td><td>9</td></tr> </table>	1	2	3	4	5	6	7	8	9
1	2	3									
4	5	6									
7	8	9									
3CH: [7..0] 3DH: [15..8]	[Vertical_3 position for the ALC weight area] Initial data: 871, data range: 0 to 1,359 Sets the horizontal 3 position for the ALC weight area.	<table border="1"> <tr><td>1</td><td>2</td><td>3</td></tr> <tr><td>4</td><td>5</td><td>6</td></tr> <tr><td>7</td><td>8</td><td>9</td></tr> </table>	1	2	3	4	5	6	7	8	9
1	2	3									
4	5	6									
7	8	9									
3EH: [7..0] 3FH: [15..8]	[Vertical_4 position for the ALC weight area] Initial data: 1,324, data range: 0 to 1,359 Sets the horizontal 4 position for the ALC weight area.	<table border="1"> <tr><td>1</td><td>2</td><td>3</td></tr> <tr><td>4</td><td>5</td><td>6</td></tr> <tr><td>7</td><td>8</td><td>9</td></tr> </table>	1	2	3	4	5	6	7	8	9
1	2	3									
4	5	6									
7	8	9									

Command No.	Command Description
48H: GainGb2[7..0]	[Preset_2 white balance (Gb gain)] Initial data: 0, data range: 0 to 255 Sets the Gb gain for the preset_2 white balance. Gb of the camera output image data = $(\text{CCD_Gb} - \text{BLACK Level}) \times (1 + \text{GainGb2}[7..0] / 64) + \text{BLACK Level}$ * CCD_Gb: Gb of the CCD output image data * BLACK Level: Black level (The calculated value of 38H)
49H: GainR3[7..0]	[Preset_3 white balance (Red gain)] Initial data: 0, data range: 0 to 255 Sets the Red gain for the preset_3 white balance. Red of the camera output image data = $(\text{CCD_R} - \text{BLACK Level}) \times (1 + \text{GainR3}[7..0] / 64) + \text{BLACK Level}$ * CCD_R: Red of the CCD output image data * BLACK Level: Black level (The calculated value of 38H)
4AH: GainGr3[7..0]	[Preset_3 white balance (Gr gain)] Initial data: 0, data range: 0 to 255 Sets the Gr gain for the preset_3 white balance. Gr of the camera output image data = $(\text{CCD_Gr} - \text{BLACK Level}) \times (1 + \text{GainGr3}[7..0] / 64) + \text{BLACK Level}$ * CCD_Gr: Red of the CCD output image data * BLACK Level: Black level (The calculated value of 38H)
4BH: GainB3[7..0]	[Preset_3 white balance (Blue gain)] Initial data: 0, data range: 0 to 255 Sets the Blue gain for the preset_3 white balance. Blue of the camera output image data = $(\text{CCD_B} - \text{BLACK Level}) \times (1 + \text{GainB3}[7..0] / 64) + \text{BLACK Level}$ * CCD_B: Blue of the CCD output image data * BLACK Level: Black level (The calculated value of 38H)
4CH: GainGb3[7..0]	[Preset_3 white balance (Gb gain)] Initial data: 0, data range: 0 to 255 Sets the Gb gain for the preset_3 white balance. Gb of the camera output image data = $(\text{CCD_Gb} - \text{BLACK Level}) \times (1 + \text{GainGb3}[7..0] / 64) + \text{BLACK Level}$ * CCD_Gb: Gb of the CCD output image data * BLACK Level: Black level (The calculated value of 38H)
4EH: [7..0] 4FH: [15..8]	[Bright level threshold fro auto white balance process] Initial data: 3,072, data range: 0 to 4,095 Sets the bright level threshold for auto white balance process. Auto white balance process uses the color information of the pixel (the brightness of the pixel that is greater than this value).
50H: [7..0] 51H: [15..8]	[Y_offset for ROI] Initial data: 0, data range: $2 \leq \text{"Y_offset"} + \text{Height} \leq 1,040$ Sets the Y_offset (the vertical start position of the image for the ROI)
52H: [7..0] 53H: [15..8]	[Height for ROI] Initial data: 1,040, data range: $2 \leq \text{"Y_offset"} + \text{Height} \leq 1,040$ Sets the height (the vertical size of the image for the ROI)
54H: [7..0] 55H: [15..8]	[X_offset for ROI] Initial data: 0, data range: $8 \leq \text{"Y_offset"} + \text{Height} \leq 1,360$ Sets the X_offset (the horizontal start position of the image for the ROI)
56H: [7..0] 57H: [15..8]	[Width for ROI] Initial data: 1,360, data range: $8 \leq \text{"Y_offset"} + \text{Height} \leq 1,360$ Sets the width (the horizontal size of the image for the ROI)

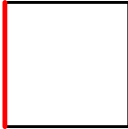
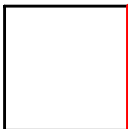
Command No.	Command Description								
58H: [7..0] 59H: [15..8]	<p>[Vertical_1 position for the white balance area] Initial data: 0, data range: 0 to 1,039 Sets the vertical 1 position, which is the vertical start position for the white balance area. This area is used for the gain calculation of the auto white balance and the push-to-set white balance.</p> 								
5AH: [7..0] 5BH: [15..8]	<p>[Vertical_2 position for the white balance area] Initial data: 1,039, data range: 0 to 1,039 Sets the vertical 2 position, which is the vertical end position for the white balance area. This area is used for calculating the gain of the auto white balance and the push-to-set white balance.</p> 								
5CH: [7..0] 5DH: [15..8]	<p>[Horizontal_1 position for the white balance area] Initial data: 0, data range: 0 to 1,539 Sets the horizontal 1 position, which is the vertical end position for the white balance area. This area is used for calculating the gain of the auto white balance and the push-to-set white balance.</p> 								
5EH: [7..0] 5FH: [15..8]	<p>[Horizontal_2 position for the white balance area] Initial data: 1,539, data range: 0 to 1,539 Sets the horizontal 2 position, which is the vertical end position for the white balance area. This area is used for the calculating the gain of the auto white balance and the push-to-set white balance.</p> 								
60H: [7..0]	<p>[Camera mode 1] Initial data: 00H Sets the white balance area ON/OFF and the gamma table ON/OFF. D[7..0]</p> <table border="1" data-bbox="293 1361 879 1391"> <tr> <td>D7</td> <td>D6</td> <td>D5</td> <td>D4</td> <td>D3</td> <td>D2</td> <td>D1</td> <td>D0</td> </tr> </table> <p>D7 to D5: No function <u>Always set at "000"</u> D4: White balance area ON/OFF <u>0: OFF (Full screen)</u> 1: ON (setup area) D3 to D1: No function <u>Always set as "000"</u> D0: Gamma table ON/OFF <u>0: OFF (Gamma=1.0)</u> 1: ON</p>	D7	D6	D5	D4	D3	D2	D1	D0
D7	D6	D5	D4	D3	D2	D1	D0		

Command No.	Command Description
80H: GainRP[7..0]	<p>[Push to set white balance (Red gain)] Initial data: 0, data range: 0 to 255 Sets the Red gain for the Push to set white balance.</p> <p>Red of the camera output image data = $(\text{CCD_R} - \text{BLACK Level}) \times (1 + \text{GainRP}[7..0] / 64) + \text{BLACK Level}$</p> <p>*CCD_R: Red of the CCD output image data *BLACK Level: Black level (The calculated value of 38H) *CCD_Gr: Gr of the CCD output image data *BLACK Level: Black level (The calculated value of 38H)</p>
81H: GainGrP[7..0]	<p>[Push to set white balance (Gr gain)] Initial data: 0, data range: 0 to 255 Sets the Gr gain for the Push to set white balance.</p> <p>Gr of the camera output image data = $(\text{CCD_Gr} - \text{BLACK Level}) \times (1 + \text{GainGrP}[7..0] / 64) + \text{BLACK Level}$</p>
82H: GainBR[7..0]	<p>[Push to set white balance (Blue gain)] Initial data: 0, data range: 0 to 255 Sets the Blue gain for the Push to set white balance.</p> <p>Red of the camera output image data = $(\text{CCD_B} - \text{BLACK Level}) \times (1 + \text{GainBR}[7..0] / 64) + \text{BLACK Level}$</p> <p>*CCD_B: Blue of the CCD output image data *BLACK Level: Black level (The calculated value of 38H)</p>
83H: GainGbP[7..0]	<p>[Push to set white balance (Gb gain)] Initial data: 0, data range: 0 to 255 Sets the Gb gain for the Push to set white balance.</p> <p>Gb of the camera output image data = $(\text{CCD_Gb} - \text{BLACK Level}) \times (1 + \text{GainGbP}[7..0] / 64) + \text{BLACK Level}$</p> <p>*CCD_Gb: Gb of the CCD output image data *BLACK Level: Black level (The calculated value of 38H)</p>

4.1 enlCam Command / Camera Command Reference Table

GenlCam command	Camera command		
	Device	Command	Function
Width	100000	56-57H	Width for ROI (pixel)
Height	100000	52-53H	Height for ROI (pixel)
PixelFormat	000000	12H.6-7	Video out (bit)
OffsetX	100000	54-55H	X offset for ROI (pixel)
OffsetY	100000	50-51H	Y offset for ROI (pixel)
BinningVertical	000000	10H.4	Binning
ExposureMode	000000	10H.5	Trigger mode
ExposureShutterType	000000	10H.7	Electrical Shutter Type
ExposureTime	000000	20-22H	Electrical Shutter Exposure Time (us)
ExposureTimeAbs	000000	20-22H	Electrical Shutter Exposure Time (us)
ExposureTimeRaw	000000	20-22H	Exposure time of the electronic shutter
ExposureAuto	100000	20H.2	Shutter mode
Acquisition FrameRate	000000	58-5CH	Frame rate
TriggerDelay	000000	50-53H	The delay time for the trigger signal
TriggerActivation	000000	10H.6	Trigger polarity
TriggerSource	000000	12H.5	Trigger signal type
TriggerSoftware	000000	16H.0	Generate command software trigger
TriggerSoftwareSource	000000	16H.6-7	Software trigger source selection
TriggerMode	000000	11H.3	Function mode
TriggerOverlap	000000	13H.5-6	Trigger Mask
TriggerHorizontalReset	000000	12H.3-4	Exposure start Mode
LineSource0	000000	F0H.0-3	Output signal for 2 pin of the power-I/O connector
LineSource1	000000	F0H.4-7	Output signal for 3 pin of the power-I/O connector
UserOutputValue0	000000	F1H.3	UserOutput signal for 2 pin of the power-I/O connector
UserOutputValue1	000000	F1H.4	UserOutput signal for 3 pin of the power-I/O connector
LineInverter0	000000	5DH.0	Output signal polarity for 2 pin of the power-I/O connector
LineInverter1	000000	5DH.1	Output signal polarity for 3 pin of the power-I/O connector
StrobeSignalOnTime	000000	90-93H	Strobe signal active time
StrobeSignalDelay	000000	54-57H	The delay time for the strobe signal (us)

GenICam command	Camera command		
	Device	Command	Function
BalanceWhiteAuto	100000	40H.0-2	White balance mode
BalanceRatio_R_Preset1	100000	41H	Preset1 white balance (Red gain)
BalanceRatio_Gr_Preset1	100000	42H	Preset1 white balance (Gr gain)
BalanceRatio_B_Preset1	100000	43H	Preset1 white balance (Blue gain)
BalanceRatio_Gb_Preset1	100000	44H	Preset1 white balance (Gb gain)
BalanceRatio_R_Preset2	100000	45H	Preset2 white balance (Red gain)
BalanceRatio_Gr_Preset2	100000	46H	Preset2 white balance (Gr gain)
BalanceRatio_B_Preset2	100000	47H	Preset2 white balance (Blue gain)
BalanceRatio_Gb_Preset2	100000	48H	Preset2 white balance (Gb gain)
BalanceRatio_R_Preset3	100000	49H	Preset3 white balance (Red gain)
BalanceRatio_Gr_Preset3	100000	4AH	Preset3 white balance (Gr gain)
BalanceRatio_B_Preset3	100000	4BH	Preset3 white balance (Blue gain)
BalanceRatio_Gb_Preset3	100000	4CH	Preset3 white balance (Gb gain)
BalanceRatio_R_Once	100000	80H	Push to set white balance (Red gain)
BalanceRatio_Gr_Once	100000	81H	Push to set white balance (Gr gain)
BalanceRatio_B_Once	100000	82H	Push to set white balance (Blue gain)
BalanceRatio_Gb_Once	100000	83H	Push to set white balance (Gb gain)
GainAuto	100000	20H.3	AGC
GainRaw	000000	30H	CDS gain
Gain	000000	30H	CMOS Analog Gain
GainAbs	000000	30H	CMOS Analog Gain
GainRaw	000000	30H	CMOS Analog Gain
BlackLevel	000000	38H	Black Level
BlackLevelAbs	000000	38H	Black Level
BlackLevelRaw	000000	38H	Black Level
SmearHalfReduction	000000	11H.4	Smear half reduction
GammaMode	100000	60H.0	Gamma table ON/OFF
ReloadGammaData	100000	60H.7	Gamma table ON/OFF
Min_ShutterTime	100000	26-28H	The lower limit of the electronic shutter for auto shutter (us)
Max_ShutterTime	100000	23-25H	The upper limit of the electronic shutter for auto shutter (us)
AGCRange	100000	21H	AGC maximum limit
TargetBrightness	100000	2EH	Target brightness for ALC

GenICam command	Camera command		
	Device	Command	Function
ALC_Peak_Average	100000	2FH	ALC peak-average
DigitalGain	000000	31H	The digital gain
ALCWeight1	100000	29H.0-3	Weight1 for ALC
ALCWeight2	100000	29H.4-7	Weight2 for ALC
ALCWeight3	100000	2AH.0-3	Weight3 for ALC
ALCWeight4	100000	2AH.4-7	Weight4 for ALC
ALCWeight5	100000	2BH.0-3	Weight5 for ALC
ALCWeight6	100000	2BH.4-7	Weight6 for ALC
ALCWeight7	100000	2CH.0-3	Weight7 for ALC
ALCWeight8	100000	2CH.4-7	Weight8 for ALC
ALCWeight9	100000	2DH.0-3	Weight9 for ALC
ALCWindowV1	100000	30-31H	Vertical1 position for the ALC weight area (pixel)
ALCWindowV2	100000	32-33H	Vertical2 position for the ALC weight area (pixel)
ALCWindowV3	100000	34-35H	Vertical3 position for the ALC weight area (pixel)
ALCWindowV4	100000	36-37H	Vertical4 position for the ALC weight area (pixel)
ALCWindowH1	100000	38-39H	Horizontal1 position for the ALC weight area (pixel)
ALCWindowH2	100000	3A-3BH	Horizontal2 position for the ALC weight area (pixel)
ALCWindowH3	100000	3C-3DH	Horizontal3 position for the ALC weight area (pixel)
ALCWindowH4	100000	3E-3FH	Horizontal4 position for the ALC weight area (pixel)
WB_WindowH1	100000	58-59H	Vertical1 position for the white balance area
WB_WindowH2	100000	5A-5BH	Vertical2 position for the white balance area
WB_WindowV1	100000	5C-5DH	Horizontal1 position for the white balance area
WB_WindowV2	100000	5E-5FH	Horizontal2 position for the white balance area
WB_WindowMode	100000	60H.4	White balance area ON/OFF
YThreshold	100000	4E-4FH	Bright level threshold for auto white balance
DeviceID			Camera Serial Number

Caution:

Width, Height and PixelFormat are effect to the image data size.

Please use GenICam command name command when change these values like below sample code.

In the case to change the Width

```

BOOL SetWidth( PvDevice *pDevice, PvInt64 IValue )
{
    PvGenInteger* IGenInteger = dynamic_cast<PvGenInteger*>( pDevice->GetGenParameters()->Get( "Width" ) );
    PvResult IResult = IGenInteger->SetValue(IValue);
    return IResult.IsOK();
}

```

5 Saving and Loading a User Set data

This camera can save and load the camera parameters. It is included restoring the factory defaults. There are two kind of data are exist.

Default: The factory defaults data
UserSet1: User accessible data for saving

The data is loaded and written into in the register on RAM of camera. These functions can be accessed through the parameters (UserSetSelector, UserSetDefaultSelector) and commands (serSetLoad, UserSetSave) on UserSetControl category of GenICam.

For the descriptions of the parameters and commands, please see the table as follow.

UserSetSelector	Select the feature User Set to load, save or configure.
UserSetDefaultSelector	Select the feature User Set to load and make active when the device is reset.
UserSetLoad	Load the User Set specified by UserSetSelector to the device and make it active.
UserSetSave	Save the User Set specified by UserSetSelector to the non-volatile memory if of the device.

5.1.1 When the Camera is Saving the Parameters

When the camera is saving the parameters (UserSetSave)

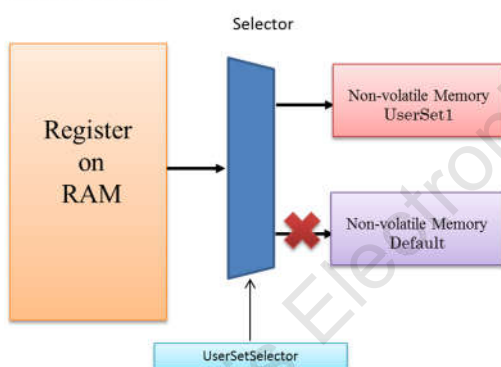

When UserSetSave is executed, The camera data on the register on RAM is saved into the memory that was selected by UserSetSelector. Caution: UserSetSave does not work with Default on UserSetSelector.

5.1.2 When the Camera is Loading the Parameters

When the camera is loading the parameters (UserSetLoad)

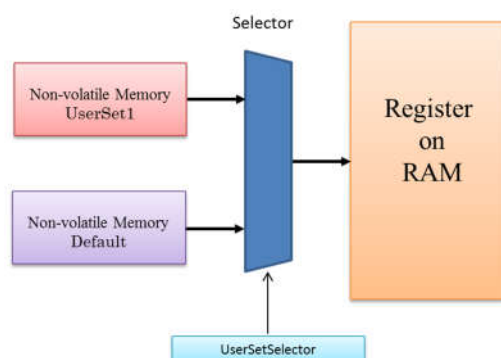

When UserSetLoad is executed, The camera data on the register on RAM is loaded from the memory that was selected by UserSetSelector.

5.1.3 When the Camera is Running

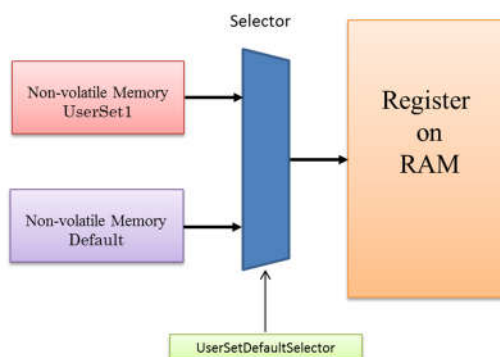
When the camera is Running

When the camera is running, The camera data is loading into the register on RAM that was selected by UserSetDefaultSelector.

5.1.4 Camera initialization (Factory Defaults)

For the recovering the factory defaults, please execute the procedure as follow.

1. Execute UserSetLoad, Default is selected on UserSetSelector.
2. Execute UserSet1 is selected on UserSetSelector.

6 Revision History

Rev	Date	Changes	Note
1.00	2012/12/29	New document	
1.01	2013/05/07	Updated Deleted: description of liris (20H,29H-3FH,92H,) on 4.4.2 Deleted: description of liris (GenIcam command) on 4.5 Added the typical IO circuit	
1.02	2014/03/28	Updated Added GenIcam Commands Revised 19H register	

Aegis Electronic Group, Inc.

Aegis Electronic Group, Inc.

OMRON SENTECH CO., LTD.

 (888)687-6877
ELECTRONIC GROUP, INC
